



**IAR Embedded  
Workbench**

# C-SPY® Debugging Guide

for the STMicroelectronics  
**STM8 microcontroller Family**

## **COPYRIGHT NOTICE**

© 2013-2017 IAR Systems AB.

No part of this document may be reproduced without the prior written consent of IAR Systems AB. The software described in this document is furnished under a license and may only be used or copied in accordance with the terms of such a license.

## **DISCLAIMER**

The information in this document is subject to change without notice and does not represent a commitment on any part of IAR Systems. While the information contained herein is assumed to be accurate, IAR Systems assumes no responsibility for any errors or omissions.

In no event shall IAR Systems, its employees, its contractors, or the authors of this document be liable for special, direct, indirect, or consequential damage, losses, costs, charges, claims, demands, claim for lost profits, fees, or expenses of any nature or kind.

## **TRADEMARKS**

IAR Systems, IAR Embedded Workbench, IAR Connect, C-SPY, C-RUN, C-STAT, IAR Visual State, visualSTATE, IAR KickStart Kit, I-jet, I-jet Trace, I-scope, IAR Academy, IAR, and the logotype of IAR Systems are trademarks or registered trademarks owned by IAR Systems AB.

Microsoft and Windows are registered trademarks of Microsoft Corporation.

STMicroelectronics is a registered trademark of STMicroelectronics Corporation. STM8 is a trademark of STMicroelectronics Corporation.

Adobe and Acrobat Reader are registered trademarks of Adobe Systems Incorporated.

All other product names are trademarks or registered trademarks of their respective owners.

## **EDITION NOTICE**

Third edition: May 2017

Part number: UCSSTM8-3

This guide applies to version 3.x of IAR Embedded Workbench® for the STMicroelectronics STM8 microcontroller family.

Internal reference: M23, Mym8.0, IMAE.

# Brief contents

Tables .....	17
Preface .....	19
<b>Part 1. Basic debugging</b> .....	25
The IAR C-SPY Debugger .....	27
Getting started using C-SPY .....	37
Executing your application .....	55
Variables and expressions .....	77
Breakpoints .....	101
Memory and registers .....	127
<b>Part 2. Analyzing your application</b> .....	163
Trace .....	165
The application timeline .....	183
Profiling .....	211
Code coverage .....	221
<b>Part 3. Advanced debugging</b> .....	227
Interrupts .....	229
C-SPY macros .....	253
The C-SPY command line utility— <code>cspybat</code> .....	307
<b>Part 4. Additional reference information</b> .....	321
Debugger options .....	323

Additional information on C-SPY drivers .....	331
Index .....	341

# Contents

Tables .....	17
Preface .....	19
<b>Who should read this guide</b> .....	19
Required knowledge .....	19
<b>What this guide contains</b> .....	19
Part 1. Basic debugging .....	19
Part 2. Analyzing your application .....	20
Part 3. Advanced debugging .....	20
Part 4. Additional reference information .....	20
<b>Other documentation</b> .....	21
User and reference guides .....	21
The online help system .....	21
Web sites .....	22
<b>Document conventions</b> .....	22
Typographic conventions .....	22
Naming conventions .....	23
<b>Part I. Basic debugging</b> .....	25
The IAR C-SPY Debugger .....	27
<b>Introduction to C-SPY</b> .....	27
An integrated environment .....	27
General C-SPY debugger features .....	28
RTOS awareness .....	29
<b>Debugger concepts</b> .....	29
C-SPY and target systems .....	30
The debugger .....	31
The target system .....	31
The application .....	31
C-SPY debugger systems .....	31
The ROM-monitor program .....	31

Third-party debuggers .....	32
C-SPY plugin modules .....	32
<b>C-SPY drivers overview</b> .....	32
Differences between the C-SPY drivers .....	33
<b>The IAR C-SPY Simulator</b> .....	33
<b>The C-SPY hardware debugger drivers</b> .....	34
Communication overview .....	34
Getting started using C-SPY .....	37
<b>Setting up C-SPY</b> .....	37
Setting up for debugging .....	37
Executing from reset .....	38
Using a setup macro file .....	38
Selecting a device description file .....	38
Loading plugin modules .....	39
<b>Starting C-SPY</b> .....	39
Starting a debug session .....	39
Loading executable files built outside of the IDE .....	40
Starting a debug session with source files missing .....	40
Loading multiple images .....	41
Editing in C-SPY windows .....	42
<b>Adapting for target hardware</b> .....	42
Modifying a device description file .....	43
Initializing target hardware before C-SPY starts .....	43
Setting option bytes .....	44
<b>Reference information on starting C-SPY</b> .....	45
C-SPY Debugger main window .....	45
Images window .....	49
Get Alternative File dialog box .....	50
Option Bytes dialog box .....	52
Executing your application .....	55
<b>Introduction to application execution</b> .....	55
Briefly about application execution .....	55
Source and disassembly mode debugging .....	55

Single stepping .....	56
Troubleshooting slow stepping speed .....	58
Running the application .....	59
Highlighting .....	60
Viewing the call stack .....	60
Terminal input and output .....	61
Debug logging .....	61
<b>Reference information on application execution .....</b>	<b>62</b>
Disassembly window .....	63
Call Stack window .....	67
Terminal I/O window .....	69
Terminal I/O Log File dialog box .....	70
Debug Log window .....	71
Log File dialog box .....	72
Report Assert dialog box .....	73
Autostep settings dialog box .....	74
Cores window .....	74
<b>Variables and expressions .....</b>	<b>77</b>
<b>Introduction to working with variables and expressions .....</b>	<b>77</b>
Briefly about working with variables and expressions .....	77
C-SPY expressions .....	78
Limitations on variable information .....	80
<b>Working with variables and expressions .....</b>	<b>81</b>
Using the windows related to variables and expressions .....	81
Viewing assembler variables .....	82
<b>Reference information on working with variables and expressions .....</b>	<b>83</b>
Auto window .....	83
Locals window .....	85
Watch window .....	87
Live Watch window .....	90
Statics window .....	92
Quick Watch window .....	95

Symbols window .....	98
Resolve Symbol Ambiguity dialog box .....	99
<b>Breakpoints .....</b>	<b>101</b>
<b>Introduction to setting and using breakpoints .....</b>	<b>101</b>
Reasons for using breakpoints .....	101
Briefly about setting breakpoints .....	101
Breakpoint types .....	102
Breakpoint icons .....	104
Breakpoints in the C-SPY simulator .....	104
Breakpoints in the C-SPY hardware debugger drivers .....	104
Breakpoint consumers .....	105
<b>Setting breakpoints .....</b>	<b>106</b>
Various ways to set a breakpoint .....	106
Toggling a simple code breakpoint .....	107
Setting breakpoints using the dialog box .....	107
Setting a data breakpoint in the Memory window .....	108
Setting breakpoints using system macros .....	109
Useful breakpoint hints .....	110
<b>Reference information on breakpoints .....</b>	<b>111</b>
Breakpoints window .....	112
Breakpoint Usage window .....	113
Advanced breakpoints dialog box .....	114
Code breakpoints dialog box .....	117
Log breakpoints dialog box .....	119
Data breakpoints dialog box .....	120
Data Log breakpoints dialog box .....	122
Immediate breakpoints dialog box .....	123
Enter Location dialog box .....	124
Resolve Source Ambiguity dialog box .....	126
<b>Memory and registers .....</b>	<b>127</b>
<b>Introduction to monitoring memory and registers .....</b>	<b>127</b>
Briefly about monitoring memory and registers .....	127
C-SPY memory zones .....	128



Memory configuration for the C-SPY simulator .....	129
<b>Monitoring memory and registers .....</b>	<b>130</b>
Defining application-specific register groups .....	130
Monitoring stack usage .....	131
<b>Reference information on memory and registers .....</b>	<b>134</b>
Memory window .....	135
Memory Save dialog box .....	139
Memory Restore dialog box .....	140
Fill dialog box .....	141
Symbolic Memory window .....	142
Stack window .....	145
Registers window .....	148
Register User Groups Setup window .....	151
SFR Setup window .....	153
Edit SFR dialog box .....	156
Memory Configuration dialog box, for the C-SPY simulator .....	158
Edit Memory Range dialog box, for the C-SPY simulator .....	160
<b>Part 2. Analyzing your application .....</b>	<b>163</b>
<b>Trace .....</b>	<b>165</b>
<b>Introduction to using trace .....</b>	<b>165</b>
Reasons for using trace .....	165
Briefly about trace .....	165
Requirements for using trace .....	166
<b>Collecting and using trace data .....</b>	<b>166</b>
Getting started with trace .....	166
Trace data collection using breakpoints .....	166
Searching in trace data .....	167
Browsing through trace data .....	167
<b>Reference information on trace .....</b>	<b>168</b>
Trace Settings dialog box .....	168
Trace window .....	170
Function Trace window .....	175

Trace Start breakpoints dialog box .....	176
Trace Stop breakpoints dialog box .....	177
Trace Expressions window .....	178
Find in Trace dialog box .....	180
Find in Trace window .....	181
<b>The application timeline .....</b>	<b>183</b>
<b>Introduction to analyzing your application's timeline .....</b>	<b>183</b>
Briefly about analyzing the timeline .....	183
Requirements for timeline support .....	184
<b>Analyzing your application's timeline .....</b>	<b>185</b>
Displaying a graph in the Timeline window .....	185
Navigating in the graphs .....	185
Analyzing performance using the graph data .....	186
Getting started using data logging .....	187
Getting started using data sampling .....	188
<b>Reference information on application timeline .....</b>	<b>188</b>
Timeline window—Call Stack graph .....	189
Timeline window—Data Log graph .....	192
Data Log window .....	196
Data Log Summary window .....	199
Sampled Graphs window .....	202
Data Sample Setup window .....	205
Data Sample window .....	207
Viewing Range dialog box .....	209
<b>Profiling .....</b>	<b>211</b>
<b>Introduction to the profiler .....</b>	<b>211</b>
Reasons for using the profiler .....	211
Briefly about the profiler .....	211
Requirements for using the profiler .....	212
<b>Using the profiler .....</b>	<b>213</b>
Getting started using the profiler on function level .....	213
Analyzing the profiling data .....	213
Getting started using the profiler on instruction level .....	215

<b>Reference information on the profiler</b> .....	216
Function Profiler window .....	216
Code coverage .....	221
<b>Introduction to code coverage</b> .....	221
Reasons for using code coverage .....	221
Briefly about code coverage .....	221
Requirements and restrictions for using code coverage .....	221
<b>Reference information on code coverage</b> .....	222
Code Coverage window .....	222
<b>Part 3. Advanced debugging</b> .....	227
Interrupts .....	229
<b>Introduction to interrupts</b> .....	229
Briefly about the interrupt simulation system .....	229
Interrupt characteristics .....	230
Interrupt simulation states .....	231
C-SPY system macros for interrupt simulation .....	232
Target-adapting the interrupt simulation system .....	233
Briefly about interrupt logging .....	233
<b>Using the interrupt system</b> .....	233
Simulating a simple interrupt .....	234
Simulating an interrupt in a multi-task system .....	235
Getting started using interrupt logging .....	236
<b>Reference information on interrupts</b> .....	236
Interrupt Configuration window .....	237
Available Interrupts window .....	240
Interrupt Status window .....	241
Interrupt Log window .....	243
Interrupt Log Summary window .....	246
Timeline window—Interrupt Log graph .....	248

C-SPY macros .....	253
<b>Introduction to C-SPY macros</b> .....	253
Reasons for using C-SPY macros .....	253
Briefly about using C-SPY macros .....	254
Briefly about setup macro functions and files .....	254
Briefly about the macro language .....	254
<b>Using C-SPY macros</b> .....	255
Registering C-SPY macros—an overview .....	256
Executing C-SPY macros—an overview .....	256
Registering and executing using setup macros and setup files .....	257
Executing macros using Quick Watch .....	257
Executing a macro by connecting it to a breakpoint .....	258
Aborting a C-SPY macro .....	259
<b>Reference information on the macro language</b> .....	260
Macro functions .....	260
Macro variables .....	260
Macro parameters .....	261
Macro strings .....	261
Macro statements .....	262
Formatted output .....	263
<b>Reference information on reserved setup macro function names</b> .....	265
execUserPreload .....	265
execUserExecutionStarted .....	266
execUserExecutionStopped .....	266
execUserSetup .....	266
execUserPreReset .....	267
execUserReset .....	267
execUserExit .....	267
<b>Reference information on C-SPY system macros</b> .....	267
__abortLaunch .....	269
__cancelAllInterrupts .....	270
__cancelInterrupt .....	270

__clearBreak .....	271
__closeFile .....	271
__delay .....	271
__disableInterrupts .....	272
__driverType .....	272
__enableInterrupts .....	273
__evaluate .....	273
__fillMemory8 .....	274
__fillMemory16 .....	274
__fillMemory32 .....	275
__isBatchMode .....	276
__loadImage .....	277
__memoryRestore .....	278
__memorySave .....	278
__messageBoxYesCancel .....	279
__messageBoxYesNo .....	280
__openFile .....	280
__orderInterrupt .....	282
__popSimulatorInterruptExecutingStack .....	283
__readFile .....	283
__readFileByte .....	284
__readMemory8, __readMemoryByte .....	284
__readMemory16 .....	285
__readMemory32 .....	285
__registerMacroFile .....	286
__resetFile .....	286
__setCodeBreak .....	287
__setDataBreak .....	288
__setDataLogBreak .....	289
__setLogBreak .....	290
__setSimBreak .....	291
__setTraceStartBreak .....	292
__setTraceStopBreak .....	293
__sourcePosition .....	294

__strFind .....	294
__subString .....	295
__targetDebuggerVersion .....	295
__toLower .....	296
__toString .....	296
__toUpper .....	297
__unloadImage .....	297
__writeFile .....	298
__writeFileByte .....	298
__writeMemory8, __writeMemoryByte .....	299
__writeMemory16 .....	299
__writeMemory32 .....	300
<b>Graphical environment for macros</b> .....	300
Macro Registration window .....	301
Debugger Macros window .....	303
Macro Quicklaunch window .....	305
The C-SPY command line utility—cspybat .....	307
<b>Using C-SPY in batch mode</b> .....	307
Starting cspybat .....	307
Output .....	308
Invocation syntax .....	308
<b>Summary of C-SPY command line options</b> .....	309
General cspybat options .....	309
Options available for all C-SPY drivers .....	310
Options available for the simulator driver .....	310
Options available for the C-SPY hardware drivers .....	310
Options available for the C-SPY STice driver .....	310
<b>Reference information on C-SPY command line options</b> ...	310
--attach_to_running_target .....	310
--backend .....	311
--code_coverage_file .....	311
--cycles .....	312
--debugfile .....	312

--disable_interrupts .....	313
--download_only .....	313
--erase_memory .....	313
-f .....	314
--leave_target_running .....	314
--log_file .....	315
--macro .....	315
--macro_param .....	316
--mapu .....	316
--mcuname .....	317
-p .....	317
--plugin .....	317
--silent .....	318
--suppress_download .....	318
--swim .....	319
--timeout .....	319
--verify_download .....	319

## **Part 4. Additional reference information** ..... 321

### **Debugger options** ..... 323

#### **Setting debugger options** ..... 323

#### **Reference information on general debugger options** ..... 323

##### Setup ..... 324

##### Images ..... 325

##### Extra Options ..... 326

##### Plugins ..... 327

#### **Reference information on C-SPY hardware debugger driver options** ..... 327

##### Setup options for STice and ST-LINK ..... 328

### **Additional information on C-SPY drivers** ..... 331

#### **Reference information on C-SPY driver menus** ..... 331

##### *C-SPY driver* ..... 331

Simulator menu .....	332
<b>Reference information on the C-SPY simulator .....</b>	<b>333</b>
Simulated Frequency dialog box .....	334
<b>Reference information on the C-SPY hardware debugger</b>	
<b>drivers .....</b>	<b>334</b>
The ST-LINK menu .....	335
The STice menu .....	336
<b>Resolving problems .....</b>	<b>338</b>
Write failure during load .....	338
No contact with the target hardware .....	339
<b>Index .....</b>	<b>341</b>



# Tables

1: Typographic conventions used in this guide .....	22
2: Naming conventions used in this guide .....	23
3: Driver differences .....	33
4: C-SPY assembler symbols expressions .....	79
5: Handling name conflicts between hardware registers and assembler labels .....	79
6: Available breakpoints in C-SPY hardware debugger drivers .....	105
7: C-SPY macros for breakpoints .....	109
8: Supported graphs in the Timeline window .....	184
9: C-SPY driver profiling support .....	212
10: Project options for enabling the profiler .....	213
11: Project options for enabling code coverage .....	222
12: Timer interrupt settings .....	235
13: Examples of C-SPY macro variables .....	261
14: Summary of system macros .....	267
15: __cancelInterrupt return values .....	270
16: __disableInterrupts return values .....	272
17: __driverType return values .....	272
18: __enableInterrupts return values .....	273
19: __evaluate return values .....	273
20: __isBatchMode return values .....	276
21: __loadImage return values .....	277
22: __messageBoxYesCancel return values .....	279
23: __messageBoxYesNo return values .....	280
24: __openFile return values .....	281
25: __readFile return values .....	283
26: __setCodeBreak return values .....	287
27: __setDataBreak return values .....	288
28: __setDataLogBreak return values .....	289
29: __setLogBreak return values .....	290
30: __setSimBreak return values .....	291
31: __setTraceStartBreak return values .....	292

32: __setTraceStopBreak return values .....	293
33: __sourcePosition return values .....	294
34: __unloadImage return values .....	298
35: cspybat parameters .....	308

# Preface

Welcome to the *C-SPY® Debugging Guide*. The purpose of this guide is to help you fully use the features in the IAR C-SPY® Debugger for debugging your application based on the STM8 microcontroller.

---

## Who should read this guide

Read this guide if you plan to develop an application using IAR Embedded Workbench and want to get the most out of the features available in C-SPY.

### REQUIRED KNOWLEDGE

To use the tools in IAR Embedded Workbench, you should have working knowledge of:

- The architecture and instruction set of the STM8 microcontroller (refer to the chip manufacturer's documentation)
- The C or C++ programming language
- Application development for embedded systems
- The operating system of your host computer.

For more information about the other development tools incorporated in the IDE, refer to their respective documentation, see *Other documentation*, page 21.

---

## What this guide contains

Below is a brief outline and summary of the chapters in this guide.

**Note:** Some of the screenshots in this guide are taken from a similar product and not from IAR Embedded Workbench for STM8.

### PART I. BASIC DEBUGGING

- *The IAR C-SPY Debugger* introduces you to the C-SPY debugger and to the concepts that are related to debugging in general and to C-SPY in particular. The chapter also introduces the various C-SPY drivers. The chapter briefly shows the difference in functionality that the various C-SPY drivers provide.
- *Getting started using C-SPY* helps you get started using C-SPY, which includes setting up, starting, and adapting C-SPY for target hardware.

- *Executing your application* describes the conceptual differences between source and disassembly mode debugging, the facilities for executing your application, and finally, how you can handle terminal input and output.
- *Variables and expressions* describes the syntax of the expressions and variables used in C-SPY, as well as the limitations on variable information. The chapter also demonstrates the various methods for monitoring variables and expressions.
- *Breakpoints* describes the breakpoint system and the various ways to set breakpoints.
- *Memory and registers* shows how you can examine memory and registers.

## **PART 2. ANALYZING YOUR APPLICATION**

- *Trace* describes how you can inspect the program flow up to a specific state using trace data.
- *The application timeline* describes the **Timeline** window, and how to use the information in it to analyze your application's behavior.
- *Profiling* describes how the profiler can help you find the functions in your application source code where the most time is spent during execution.
- *Code coverage* describes how the code coverage functionality can help you verify whether all parts of your code have been executed, thus identifying parts which have not been executed.

## **PART 3. ADVANCED DEBUGGING**

- *Interrupts* contains detailed information about the C-SPY interrupt simulation system and how to configure the simulated interrupts to make them reflect the interrupts of your target hardware.
- *C-SPY macros* describes the C-SPY macro system, its features, the purposes of these features, and how to use them.
- *The C-SPY command line utility—`cspybat`* describes how to use C-SPY in batch mode.

## **PART 4. ADDITIONAL REFERENCE INFORMATION**

- *Debugger options* describes the options you must set before you start the C-SPY debugger.
- *Additional information on C-SPY drivers* describes menus and features provided by the C-SPY drivers not described in any dedicated topics.

---

## Other documentation

User documentation is available as hypertext PDFs and as a context-sensitive online help system in HTML format. You can access the documentation from the Information Center or from the **Help** menu in the IAR Embedded Workbench IDE. The online help system is also available via the F1 key.

### USER AND REFERENCE GUIDES

The complete set of IAR Systems development tools is described in a series of guides. Information about:

- System requirements and information about how to install and register the IAR Systems products, is available in the booklet Quick Reference (available in the product box) and the *Installation and Licensing Guide*.
- Using the IDE for project management and building, is available in the *IDE Project Management and Building Guide for STM8*.
- Using the IAR C-SPY® Debugger, is available in the *C-SPY® Debugging Guide for STM8*.
- Programming for the IAR C/C++ Compiler for STM8 and linking using the IAR ILINK Linker, is available in the *IAR C/C++ Development Guide for STM8*.
- Programming for the IAR Assembler for STM8, is available in the *IAR Assembler Reference Guide for STM8*.
- Performing a static analysis using C-STAT and the required checks, is available in the *C-STAT Static Analysis Guide*.
- Developing safety-critical applications using the MISRA C guidelines, is available in the *IAR Embedded Workbench® MISRA C:2004 Reference Guide* or the *IAR Embedded Workbench® MISRA C:1998 Reference Guide*.

**Note:** Additional documentation might be available depending on your product installation.

### THE ONLINE HELP SYSTEM

The context-sensitive online help contains:

- Information about project management, editing, and building in the IDE
- Information about debugging using the IAR C-SPY® Debugger
- Reference information about the menus, windows, and dialog boxes in the IDE
- Compiler reference information
- Keyword reference information for the DLIB library functions. To obtain reference information for a function, select the function name in the editor window and press F1.

## WEB SITES

Recommended web sites:

- The STMicroelectronics web site **www.st.com**, that contains information and news about the STM8 microcontrollers.
- The IAR Systems web site, **www.iar.com**, that holds application notes and other product information.
- The web site of the C standardization working group, **www.open-std.org/jtc1/sc22/wg14**.
- The web site of the C++ Standards Committee, **www.open-std.org/jtc1/sc22/wg21**.
- The C++ programming language web site, **isocpp.org**.  
This web site also has a list of recommended books about C++ programming.
- The C and C++ reference web site, **en.cppreference.com**.

---

## Document conventions

When, in the IAR Systems documentation, we refer to the programming language C, the text also applies to C++, unless otherwise stated.

When referring to a directory in your product installation, for example `stm8\doc`, the full path to the location is assumed, for example `c:\Program Files\IAR Systems\Embedded Workbench N.n\stm8\doc`, where the initial digit of the version number reflects the initial digit of the version number of the IAR Embedded Workbench shared components.

## TYPOGRAPHIC CONVENTIONS

The IAR Systems documentation set uses the following typographic conventions:

Style	Used for
<code>computer</code>	<ul style="list-style-type: none"> <li>• Source code examples and file paths.</li> <li>• Text on the command line.</li> <li>• Binary, hexadecimal, and octal numbers.</li> </ul>
<i>parameter</i>	A placeholder for an actual value used as a parameter, for example <i>filename.h</i> where <i>filename</i> represents the name of the file.
[option]	An optional part of a directive, where [ and ] are not part of the actual directive, but any [, ], {, or } are part of the directive syntax.
{option}	A mandatory part of a directive, where { and } are not part of the actual directive, but any [, ], {, or } are part of the directive syntax.
[option]	An optional part of a command.

Table 1: Typographic conventions used in this guide





Style	Used for
[a   b   c]	An optional part of a command with alternatives.
{a   b   c}	A mandatory part of a command with alternatives.
<b>bold</b>	Names of menus, menu commands, buttons, and dialog boxes that appear on the screen.
<i>italic</i>	<ul style="list-style-type: none"> <li>• A cross-reference within this guide or to another guide.</li> <li>• Emphasis.</li> </ul>
...	An ellipsis indicates that the previous item can be repeated an arbitrary number of times.
	Identifies instructions specific to the IAR Embedded Workbench® IDE interface.
	Identifies instructions specific to the command line interface.
	Identifies helpful tips and programming hints.
	Identifies warnings.

Table 1: Typographic conventions used in this guide (Continued)

## NAMING CONVENTIONS

The following naming conventions are used for the products and tools from IAR Systems®, when referred to in the documentation:

Brand name	Generic term
IAR Embedded Workbench® for STM8	IAR Embedded Workbench®
IAR Embedded Workbench® IDE for STM8	the IDE
IAR C-SPY® Debugger for STM8	C-SPY, the debugger
IAR C-SPY® Simulator	the simulator
IAR C/C++ Compiler™ for STM8	the compiler
IAR Assembler™ for STM8	the assembler
IAR ILINK Linker™	ILINK, the linker
IAR DLIB Runtime Environment™	the DLIB runtime environment

Table 2: Naming conventions used in this guide





# Part I. Basic debugging

This part of the *C-SPY® Debugging Guide for STM8* includes these chapters:

- The IAR C-SPY Debugger
- Getting started using C-SPY
- Executing your application
- Variables and expressions
- Breakpoints
- Memory and registers

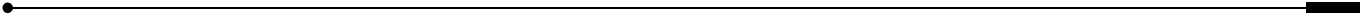
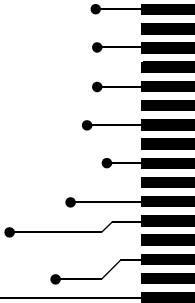

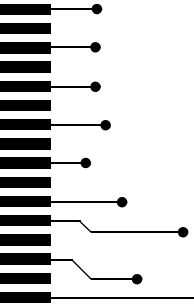

# The IAR C-SPY Debugger

- Introduction to C-SPY
- Debugger concepts
- C-SPY drivers overview
- The IAR C-SPY Simulator
- The C-SPY hardware debugger drivers

---

## Introduction to C-SPY

These topics are covered:

- An integrated environment
- General C-SPY debugger features
- RTOS awareness

### AN INTEGRATED ENVIRONMENT

C-SPY is a high-level-language debugger for embedded applications. It is designed for use with the IAR Systems compilers and assemblers, and is completely integrated in the IDE, providing development and debugging within the same application. This will give you possibilities such as:

- Editing while debugging. During a debug session, you can make corrections directly in the same source code window that is used for controlling the debugging. Changes will be included in the next project rebuild.
- Setting breakpoints at any point during the development cycle. You can inspect and modify breakpoint definitions also when the debugger is not running, and breakpoint definitions flow with the text as you edit. Your debug settings, such as watch properties, window layouts, and register groups will be preserved between your debug sessions.

All windows that are open in the Embedded Workbench workspace will stay open when you start the C-SPY Debugger. In addition, a set of C-SPY-specific windows are opened.

## GENERAL C-SPY DEBUGGER FEATURES

Because IAR Systems provides an entire toolchain, the output from the compiler and linker can include extensive debug information for the debugger, resulting in good debugging possibilities for you.

C-SPY offers these general features:

- Source and disassembly level debugging
 

C-SPY allows you to switch between source and disassembly debugging as required, for both C or C++ and assembler source code.
- Single-stepping on a function call level
 

Compared to traditional debuggers, where the finest granularity for source level stepping is line by line, C-SPY provides a finer level of control by identifying every statement and function call as a step point. This means that each function call—inside expressions, and function calls that are part of parameter lists to other functions—can be single-stepped. The latter is especially useful when debugging C++ code, where numerous extra function calls are made, for example to object constructors.
- Code and data breakpoints
 

The C-SPY breakpoint system lets you set breakpoints of various kinds in the application being debugged, allowing you to stop at locations of particular interest. For example, you set breakpoints to investigate whether your program logic is correct or to investigate how and when the data changes.
- Monitoring variables and expressions
 

For variables and expressions there is a wide choice of facilities. You can easily monitor values of a specified set of variables and expressions, continuously or on demand. You can also choose to monitor only local variables, static variables, etc.
- Container awareness
 

When you run your application in C-SPY, you can view the elements of library data types such as STL lists and vectors. This gives you a very good overview and debugging opportunities when you work with C++ STL containers.
- Call stack information
 

The compiler generates extensive call stack information. This allows the debugger to show, without any runtime penalty, the complete stack of function calls wherever the program counter is. You can select any function in the call stack, and for each function you get valid information for local variables and available registers.
- Powerful macro system
 

C-SPY includes a powerful internal macro system, to allow you to define complex sets of actions to be performed. C-SPY macros can be used on their own or in

conjunction with complex breakpoints and—if you are using the simulator—the interrupt simulation system to perform a wide variety of tasks.

### **Additional general C-SPY debugger features**

This list shows some additional features:

- Threaded execution keeps the IDE responsive while running the target application
- Automatic stepping
- The source browser provides easy navigation to functions, types, and variables
- Extensive type recognition of variables
- Configurable registers (CPU and peripherals) and memory windows
- Graphical stack view with overflow detection
- Support for code coverage and function level profiling
- The target application can access files on the host PC using file I/O
- Optional terminal I/O emulation.

### **RTOS AWARENESS**

C-SPY supports RTOS-aware debugging.

These operating systems are currently supported:

- OSEK Run Time Interface (ORTI)
- Segger embOS

RTOS plugin modules can be provided by IAR Systems, and by third-party suppliers. Contact your software distributor or IAR Systems representative, alternatively visit the IAR Systems web site, for information about supported RTOS modules.

A C-SPY RTOS awareness plugin module gives you a high level of control and visibility over an application built on top of an RTOS. It displays RTOS-specific items like task lists, queues, semaphores, mailboxes, and various RTOS system variables. Task-specific breakpoints and task-specific stepping make it easier to debug tasks.

A loaded plugin will add its own menu, set of windows, and buttons when a debug session is started (provided that the RTOS is linked with the application). For information about other RTOS awareness plugin modules, refer to the manufacturer of the plugin module.

---

## **Debugger concepts**

This section introduces some of the concepts and terms that are related to debugging in general and to C-SPY in particular. This section does not contain specific information

related to C-SPY features. Instead, you will find such information in the other chapters of this documentation. The IAR Systems user documentation uses the terms described in this section when referring to these concepts.

These topics are covered:

- C-SPY and target systems
- The debugger
- The target system
- The application
- C-SPY debugger systems
- The ROM-monitor program
- Third-party debuggers
- C-SPY plugin modules

### C-SPY AND TARGET SYSTEMS

You can use C-SPY to debug either a software target system or a hardware target system.

This figure gives an overview of C-SPY and possible target systems:

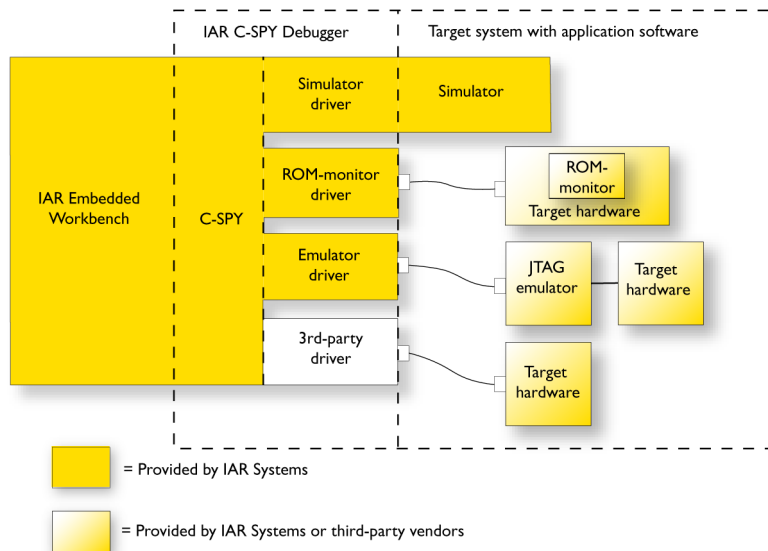

**Note:** In IAR Embedded Workbench for STM8, there are no ROM-monitor drivers.

## THE DEBUGGER

The debugger, for instance C-SPY, is the program that you use for debugging your applications on a target system.

## THE TARGET SYSTEM

The target system is the system on which you execute your application when you are debugging it. The target system can consist of hardware, either an evaluation board or your own hardware design. It can also be completely or partially simulated by software. Each type of target system needs a dedicated C-SPY driver.

## THE APPLICATION

A user application is the software you have developed and which you want to debug using C-SPY.

## C-SPY DEBUGGER SYSTEMS

C-SPY consists of both a general part which provides a basic set of debugger features, and a target-specific back end. The back end consists of two components: a processor module—one for every microcontroller, which defines the properties of the microcontroller, and a *C-SPY driver*. The C-SPY driver is the part that provides communication with and control of the target system. The driver also provides the user interface—menus, windows, and dialog boxes—to the functions provided by the target system, for instance, special breakpoints. Typically, there are three main types of C-SPY drivers:

- Simulator driver
- ROM-monitor driver
- Emulator driver.

C-SPY is available with a simulator driver, and depending on your product package, optional drivers for hardware debugger systems. For an overview of the available C-SPY drivers and the functionality provided by each driver, see *C-SPY drivers overview*, page 32.

## THE ROM-MONITOR PROGRAM

The ROM-monitor program is a piece of firmware that is loaded to non-volatile memory on your target hardware; it runs in parallel with your application. The ROM-monitor communicates with the debugger and provides services needed for debugging the application, for instance stepping and breakpoints.

## THIRD-PARTY DEBUGGERS

You can use a third-party debugger together with the IAR Systems toolchain as long as the third-party debugger can read ELF/DWARF, Intel-extended, or Motorola. For information about which format to use with a third-party debugger, see the user documentation supplied with that tool.

## C-SPY PLUGIN MODULES

C-SPY is designed as a modular architecture with an open SDK that can be used for implementing additional functionality to the debugger in the form of plugin modules. These modules can be seamlessly integrated in the IDE.

Plugin modules are provided by IAR Systems, or can be supplied by third-party vendors. Examples of such modules are:

- Code Coverage, which is integrated in the IDE.
- The various C-SPY drivers for debugging using certain debug systems.
- RTOS plugin modules for support for real-time OS aware debugging.
- C-SPYLink that bridges IAR visualSTATE and IAR Embedded Workbench to make true high-level state machine debugging possible directly in C-SPY, in addition to the normal C level symbolic debugging. For more information, see the documentation provided with IAR visualSTATE.

For more information about the C-SPY SDK, contact IAR Systems.

---

## C-SPY drivers overview

These topics are covered:

- Differences between the C-SPY drivers

At the time of writing this guide, the IAR C-SPY Debugger for the STM8 microcontrollers is available with drivers for these target systems and evaluation boards:

- Simulator
- STice
- ST-LINK.



## DIFFERENCES BETWEEN THE C-SPY DRIVERS

This table summarizes the key differences between the C-SPY drivers:

Feature	Simulator	STice	ST-LINK and STice in SWIM mode
Code breakpoints <sup>1</sup>	Unlimited	Yes	Yes
Data breakpoints <sup>1</sup>	Yes	—	Yes
Execution in real time <sup>1</sup>	—	Yes	Yes
Zero memory footprint <sup>1</sup>	Yes	Yes	Yes
Simulated interrupts <sup>1</sup>	Yes	—	—
Real interrupts <sup>1</sup>	—	Yes	Yes
Interrupt logging <sup>1</sup>	Yes	—	—
Data logging <sup>1</sup>	Yes	—	—
Live watch <sup>1</sup>	Yes	Yes	Yes
Cycle counter <sup>1</sup>	Yes	—	—
Code coverage <sup>1</sup>	Yes	Yes	—
Data coverage <sup>1</sup>	Yes	Yes	—
Function/instruction profiling <sup>1</sup>	Yes	Yes	—
Trace <sup>1</sup>	Yes	Yes	—

Table 3: Driver differences

<sup>1</sup> With specific requirements or restrictions, see the respective chapter in this guide.

## The IAR C-SPY Simulator

The C-SPY Simulator simulates the functions of the target processor entirely in software, which means that you can debug the program logic long before any hardware is available. Because no hardware is required, it is also the most cost-effective solution for many applications.

The C-SPY Simulator supports:

- Instruction-level simulation
- Memory configuration and validation
- Interrupt simulation
- Peripheral simulation (using the C-SPY macro system in conjunction with immediate breakpoints).

Simulating hardware instead of using a hardware debugging system means that some limitations do not apply, but that there are other limitations instead. For example:

- You can set an unlimited number of breakpoints in the simulator.
- When you stop executing your application, time actually stops in the simulator. When you stop application execution on a hardware debugging system, there might still be activities in the system. For example, peripheral units might still be active and reading from or writing to SFR ports.
- Application execution is significantly much slower in a simulator compared to when using a hardware debugging system. However, during a debug session, this might not necessarily be a problem.
- The simulator is not cycle accurate.
- Peripheral simulation is limited in the C-SPY Simulator and therefore the simulator is suitable mostly for debugging code that does not interact too much with peripheral units.

---

## The C-SPY hardware debugger drivers

These topics are covered:

- *Communication overview*, page 34

C-SPY can connect to a hardware debugger using a C-SPY hardware debugger driver as an interface. The C-SPY hardware debugger drivers are automatically installed during the installation of IAR Embedded Workbench.

IAR Embedded Workbench for STM8 comes with two different C-SPY hardware debugger drivers—STice and ST-LINK.

### COMMUNICATION OVERVIEW

Most target systems have a debug probe or a debug adapter connected between the host computer and the evaluation board.

The C-SPY hardware debugger driver uses USB to communicate with the hardware debugger. The hardware debugger communicates with the target STM8 microcontroller

over the SWIM interface. Alternatively, the STIce emulator can emulate an STM8 microcontroller.

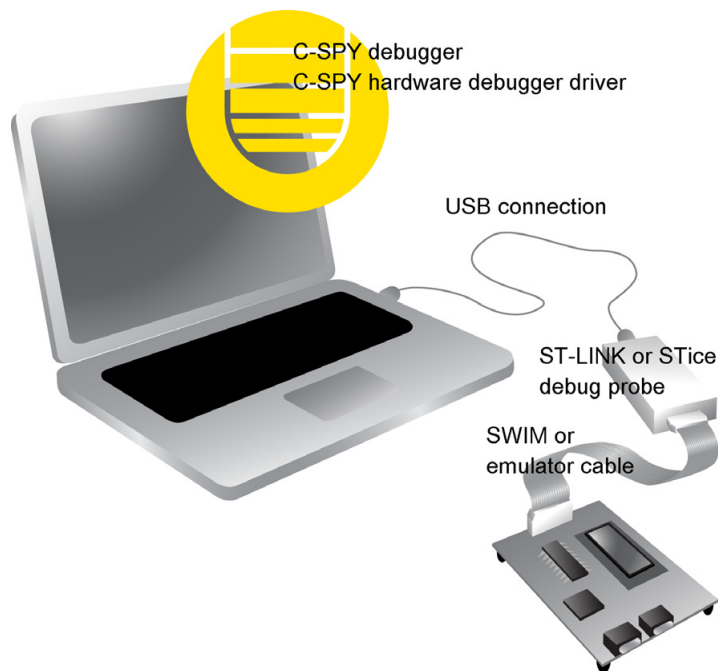

For further information, refer to the documentation supplied with the hardware debugger.

When a debug session is started, your application is automatically downloaded and programmed into flash memory. You can disable this feature, if necessary.

### Hardware installation

For information about the hardware installation, see the documentation supplied with the hardware debugger from STMicroelectronics. The following power-up sequence is recommended to ensure proper communication between the target board, hardware debugger, and C-SPY:

- 1 Power up the target board.
- 2 Power up the hardware debugger.
- 3 Start the C-SPY debugging session.



# Getting started using C-SPY

- Setting up C-SPY
- Starting C-SPY
- Adapting for target hardware
- Reference information on starting C-SPY

---

## Setting up C-SPY

These tasks are covered:

- Setting up for debugging
- Executing from reset
- Using a setup macro file
- Selecting a device description file
- Loading plugin modules

### SETTING UP FOR DEBUGGING

- 1** Before you start C-SPY, choose **Project>Options>Debugger>Setup** and select the C-SPY driver that matches your debugger system: simulator or a hardware debugger system.
- 2** In the **Category** list, select the appropriate C-SPY driver and make your settings.  
For information about these options, see *Debugger options*, page 323.
- 3** Click **OK**.
- 4** Choose **Tools>Options** to open the **IDE Options** dialog box:
  - Select **Debugger** to configure the debugger behavior
  - Select **Stack** to configure the debugger's tracking of stack usage.

For more information about these options, see the *IDE Project Management and Building Guide for STM8*.

See also *Adapting for target hardware*, page 42.

## EXECUTING FROM RESET

The **Run to** option—available on the **Debugger>Setup** page—specifies a location you want C-SPY to run to when you start a debug session as well as after each reset. C-SPY will place a temporary breakpoint at this location and all code up to this point is executed before stopping at the location. Note that this temporary breakpoint is removed when the debugger stops, regardless of how. If you stop the execution before the **Run to** location has been reached, the execution will not stop at that location when you start the execution again.

The default location to run to is the `main` function. Type the name of the location if you want C-SPY to run to a different location. You can specify assembler labels or whatever can be evaluated to such, for instance function names.

If you leave the check box empty, the program counter will contain the regular hardware reset address at each reset

If no breakpoints are available when C-SPY starts, a warning message notifies you that single stepping will be required and that this is time-consuming. You can then continue execution in single-step mode or stop at the first instruction. If you choose to stop at the first instruction, the debugger starts executing with the PC (program counter) at the default reset location instead of the location you typed in the **Run to** box.

**Note:** This message will never be displayed in the C-SPY Simulator, where breakpoints are unlimited.

## USING A SETUP MACRO FILE

A setup macro file is a macro file that you choose to load automatically when C-SPY starts. You can define the setup macro file to perform actions according to your needs, using setup macro functions and system macros. Thus, if you load a setup macro file you can initialize C-SPY to perform actions automatically.

For more information about setup macro files and functions, see *Introduction to C-SPY macros*, page 253. For an example of how to use a setup macro file, see *Initializing target hardware before C-SPY starts*, page 43.

### To register a setup macro file:

- 1 Before you start C-SPY, choose **Project>Options>Debugger>Setup**.
- 2 Select **Use macro file** and type the path and name of your setup macro file, for example `Setup.mac`. If you do not type a filename extension, the extension `mac` is assumed.

## SELECTING A DEVICE DESCRIPTION FILE

C-SPY uses device description files to handle device-specific information.

A default device description file is automatically used based on your project settings. If you want to override the default file, you must select your device description file. Device description files are provided in the `stm8\config` directory and they have the filename extension `ddf`.

For more information about device description files, see *Adapting for target hardware*, page 42.

#### To override the default device description file:

- 1 Before you start C-SPY, choose **Project>Options>Debugger>Setup**.
- 2 Enable the use of a device description file and select a file using the **Device description file** browse button.

**Note:** You can easily view your device description files that are used for your project. Choose **Project>Open Device Description File** and select the file you want to view.

### LOADING PLUGIN MODULES

On the **Plugins** page you can specify C-SPY plugin modules to load and make available during debug sessions. Plugin modules can be provided by IAR Systems, and by third-party suppliers. Contact your software distributor or IAR Systems representative, or visit the IAR Systems web site, for information about available modules.

For more information, see *Plugins*, page 327.

---

## Starting C-SPY

When you have set up the debugger, you are ready to start a debug session.

These tasks are covered:

- Starting a debug session
- Loading executable files built outside of the IDE
- Starting a debug session with source files missing
- Loading multiple images
- Editing in C-SPY windows

### STARTING A DEBUG SESSION

You can choose to start a debug session with or without loading the current executable file.



To start C-SPY and download the current executable file, click the **Download and Debug** button. Alternatively, choose **Project>Download and Debug**.

- ▶ To start C-SPY without downloading the current executable file, click the **Debug without Downloading** button. Alternatively, choose **Project>Debug without Downloading**.

## LOADING EXECUTABLE FILES BUILT OUTSIDE OF THE IDE

You can also load C-SPY with an application that was built outside the IDE, for example applications built on the command line. To load an externally built executable file and to set build options you must first create a project for it in your workspace.

### To create a project for an externally built file:

- 1 Choose **Project>Create New Project**, and specify a project name.
- 2 To add the executable file to the project, choose **Project>Add Files** and make sure to choose **All Files** in the **Files of type** drop-down list. Locate the executable file.
- ▶ 3 To start the executable file, click the **Download and Debug** button. The project can be reused whenever you rebuild your executable file.

The only project options that are meaningful to set for this kind of project are options in the **General Options** and **Debugger** categories. Make sure to set up the general project options in the same way as when the executable file was built.

## STARTING A DEBUG SESSION WITH SOURCE FILES MISSING

Normally, when you use the IAR Embedded Workbench IDE to edit source files, build your project, and start the debug session, all required files are available and the process works as expected.

However, if C-SPY cannot automatically find the source files, for example if the application was built on another computer, the **Get Alternative File** dialog box is displayed:

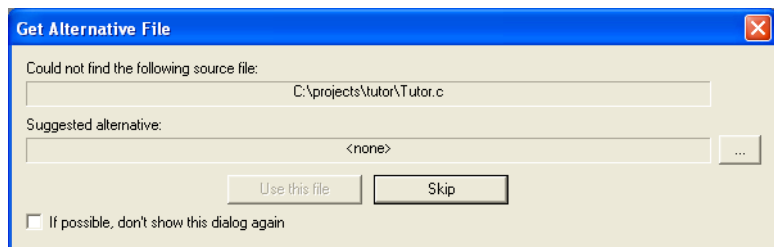

Typically, you can use the dialog box like this:

- The source files are not available: Click **If possible, don't show this dialog again** and then click **Skip**. C-SPY will assume that there simply is no source file available.



The dialog box will not appear again, and the debug session will not try to display the source code.

- Alternative source files are available at another location: Specify an alternative source code file, click **If possible, don't show this dialog again**, and then click **Use this file**. C-SPY will assume that the alternative file should be used. The dialog box will not appear again, unless a file is needed for which there is no alternative file specified and which cannot be located automatically.

If you restart the IAR Embedded Workbench IDE, the **Get Alternative File** dialog box will be displayed again once even if you have clicked **If possible, don't show this dialog again**. This gives you an opportunity to modify your previous settings.

For more information, see *Get Alternative File dialog box*, page 50.

## LOADING MULTIPLE IMAGES

Normally, a debuggable application consists of exactly one file that you debug. However, you can also load additional debug files (images). This means that the complete program consists of several images.

Typically, this is useful if you want to debug your application in combination with a prebuilt ROM image that contains an additional library for some platform-provided features. The ROM image and the application are built using separate projects in the IAR Embedded Workbench IDE and generate separate output files.

If more than one image has been loaded, you will have access to the combined debug information for all the loaded images. In the Images window you can choose whether you want to have access to debug information for one image or for all images.

### To load additional images at C-SPY startup:

- 1 Choose **Project>Options>Debugger>Images** and specify up to three additional images to be loaded. For more information, see *Images*, page 325.
- 2 Start the debug session.

To load additional images at a specific moment:

Use the `__loadImage` system macro and execute it using either one of the methods described in *Using C-SPY macros*, page 255.

To display a list of loaded images:

Choose **Images** from the **View** menu. The **Images** window is displayed, see *Images window*, page 49.

## EDITING IN C-SPY WINDOWS

You can edit the contents of the **Memory**, **Symbolic Memory**, **Registers**, **Register User Groups Setup**, **Auto**, **Watch**, **Locals**, **Statics**, **Live Watch**, and **Quick Watch** windows.

Use these keyboard keys to edit the contents of these windows:

<b>Enter</b>	Makes an item editable and saves the new value.
<b>Esc</b>	Cancels a new value.

In windows where you can edit the **Expression** field and in the **Quick Watch** window, you can specify the number of elements to be displayed in the field by adding a semicolon followed by an integer. For example, to display only the three first elements of an array named `myArray`, or three elements in sequence starting with the element pointed to by a pointer, write:

```
myArray;3
```

To display three elements pointed to by `myPtr`, `myPtr+1`, and `myPtr+2`, write:

```
myPtr;3
```

Optionally, add a comma and another integer that specifies which element to start with. For example, to display elements 10–14, write:

```
myArray;5,10
```

To display `myPtr+10`, `myPtr+11`, `myPtr+12`, `myPtr+13`, and `myPtr+14`, write:

```
myPtr;5,10
```

**Note:** For pointers, there are no built-in limits on displayed element count, and no validation of the pointer value.

---

## Adapting for target hardware

These tasks are covered:

- Modifying a device description file
- Initializing target hardware before C-SPY starts

## MODIFYING A DEVICE DESCRIPTION FILE

C-SPY uses device description files provided with the product to handle several of the target-specific adaptations, see *Selecting a device description file*, page 38. They contain device-specific information such as:

- Definitions of memory-mapped peripheral units, device-specific CPU registers, and groups of these.
- Definitions for device-specific interrupts, which makes it possible to simulate these interrupts in the C-SPY simulator; see *Interrupts*, page 229.

Normally, you do not need to modify the device description file. However, if the predefinitions are not sufficient for some reason, you can edit the file. Note, however, that the format of these descriptions might be updated in future upgrades of the product.

Make a copy of the device description file that best suits your needs, and modify it according to the description in the file. Reload the project to make the changes take effect.

For information about how to load a device description file, see *Selecting a device description file*, page 38.

## INITIALIZING TARGET HARDWARE BEFORE C-SPY STARTS

You can use C-SPY macros to initialize target hardware before C-SPY starts. For example, if your hardware uses external memory that must be enabled before code can be downloaded to it, C-SPY needs a macro to perform this action before your application can be downloaded.

- 1 Create a new text file and define your macro function.

By using the built-in `execUserPreload` setup macro function, your macro function will be executed directly after the communication with the target system is established but before C-SPY downloads your application.

For example, a macro that enables external SDRAM could look like this:

```
/* Your macro function. */
enableExternalSDRAM()
{
    __message "Enabling external SDRAM\n";
    __writeMemory32(...);
}

/* Setup macro determines time of execution. */
execUserPreload()
{
    enableExternalSDRAM();
}
```

- 2 Save the file with the filename extension `mac`.
- 3 Before you start C-SPY, choose **Project>Options>Debugger** and click the **Setup** tab.
- 4 Select the option **Use Setup file** and choose the macro file you just created.

Your setup macro will now be loaded during the C-SPY startup sequence.

## SETTING OPTION BYTES

Option bytes are used for configuring the device hardware features as well as the memory protection. You can set option bytes using one of these methods:

- Use the **Option Bytes** dialog box, available from the C-SPY driver menu. The settings you make here can be saved to an `.obc` file, which can be loaded from the dialog box or passed to the driver as a command line argument. See *Option Bytes dialog box*, page 52.
- In your source code, define the option bytes that you want to change by placing the option bytes at the correct memory addresses in the option bytes memory. When you use this method, the option bytes settings will be part of the output file (`.out`). In the I/O header file for your device, there are macros defined to help you define variables for the option bytes. For example:

```
#include "iostm8s105c6.h"

/* Define OPT0 as __no_init to keep pre-programmed value. */
__no_init OPT0_DECL;

/* Define OPT2 and NOPT2 with your own initial values. */
OPT2_DECL = 0x00;
NOPT2_DECL = ~0x00;

unsigned char Test(void)
{
    unsigned char x = 0x42;
    if (OPT0)
    {
        x = OPT2;
    }
    return x;
}
```

**Note:** When you use this method, the option bytes will not be checked for validity by IAR Embedded Workbench. Note that on some devices, some option bytes also need to be stored in complementary form.

---

## Reference information on starting C-SPY

Reference information about:

- *C-SPY Debugger main window*, page 45
- *Images window*, page 49
- *Get Alternative File dialog box*, page 50
- *Option Bytes dialog box*, page 52

See also:

- Tools options for the debugger in the *IDE Project Management and Building Guide for STM8*.

## C-SPY Debugger main window

When you start a debug session, these debugger-specific items appear in the main IAR Embedded Workbench IDE window:

- A dedicated **Debug** menu with commands for executing and debugging your application
- Depending on the C-SPY driver you are using, a driver-specific menu, often referred to as the *Driver menu* in this documentation. Typically, this menu contains menu commands for opening driver-specific windows and dialog boxes.
- A special debug toolbar
- Several windows and dialog boxes specific to C-SPY.

The C-SPY main window might look different depending on which components of the product installation you are using.

### Menu bar

These menus are available during a debug session:

#### **Debug**

Provides commands for executing and debugging the source application. Most of the commands are also available as icon buttons on the debug toolbar.

#### ***C-SPY driver menu***

Provides commands specific to a C-SPY driver. The driver-specific menu is only available when the driver is used. For information about the driver-specific menu commands, see *Reference information on C-SPY driver menus*, page 331.

## Debug menu

The **Debug** menu is available during a debug session. The **Debug** menu provides commands for executing and debugging the source application. Most of the commands are also available as icon buttons on the debug toolbar.

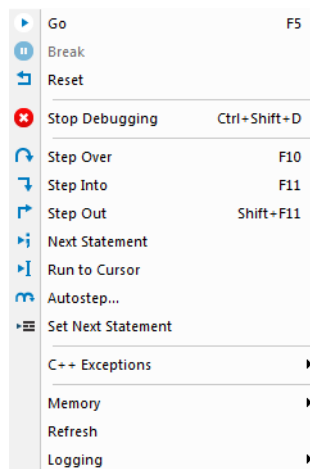

These commands are available:



### Go (F5)

Executes from the current statement or instruction until a breakpoint or program exit is reached.



### Break

Stops the application execution.



### Reset

Resets the target processor. Click the drop-down button to access a menu with additional commands.

**Enable Run to 'label'**, where *label* typically is *main*. Enables and disables the project option **Run to** without exiting the debug session. This menu command is only available if you have selected **Run to** in the **Options** dialog box.

**Reset strategies**, which contains a list of reset strategies supported by the C-SPY driver you are using. This means that you can choose a different reset strategy than the one used initially without exiting the debug session. Reset strategies are only available if the C-SPY driver you are using supports alternate reset strategies.

**Stop Debugging (Ctrl+Shift+D)**

Stops the debugging session and returns you to the project manager.

**Step Over (F10)**

Executes the next statement, function call, or instruction, without entering C or C++ functions or assembler subroutines.

**Step Into (F11)**

Executes the next statement or instruction, or function call, entering C or C++ functions or assembler subroutines.

**Step Out (Shift+F11)**

Executes from the current statement up to the statement after the call to the current function.

**Next Statement**

Executes directly to the next statement without stopping at individual function calls.

**Run to Cursor**

Executes from the current statement or instruction up to a selected statement or instruction.

**Autostep**

Displays a dialog box where you can customize and perform autostepping, see *Autostep settings dialog box*, page 74.

**Set Next Statement**

Moves the program counter directly to where the cursor is, without executing any source code. Note, however, that this creates an anomaly in the program flow and might have unexpected effects.

**C++ Exceptions>Break on Throw**

This menu command is not supported by your product package.

**C++ Exceptions>Break on Uncaught Exception**

This menu command is not supported by your product package.

**Memory>Save**

Displays a dialog box where you can save the contents of a specified memory area to a file, see *Memory Save dialog box*, page 139.

**Memory>Restore**

Displays a dialog box where you can load the contents of a file in, for example Intel-extended or Motorola s-record format to a specified memory zone, see *Memory Restore dialog box*, page 140.

### Refresh

Refreshes the contents of all debugger windows. Because window updates are automatic, this is needed only in unusual situations, such as when target memory is modified in ways C-SPY cannot detect. It is also useful if code that is displayed in the Disassembly window is changed.

### Logging>Set Log file

Displays a dialog box where you can choose to log the contents of the **Debug Log** window to a file. You can select the type and the location of the log file. You can choose what you want to log: errors, warnings, system information, user messages, or all of these. See *Log File dialog box*, page 72.

### Logging>Set Terminal I/O Log file

Displays a dialog box where you can choose to log simulated target access communication to a file. You can select the destination of the log file. See *Terminal I/O Log File dialog box*, page 70

## C-SPY windows

Depending on the C-SPY driver you are using, these windows specific to C-SPY are available during a debug session:

- C-SPY Debugger main window
- Disassembly window
- Memory window
- Symbolic Memory window
- Registers window
- Watch window
- Locals window
- Auto window
- Live Watch window
- Quick Watch window
- Statics window
- Call Stack window
- Trace window
- Function Trace window
- Timeline window, see *Reference information on application timeline*, page 188
- Terminal I/O window
- Code Coverage window
- Function Profiler window



- Images window
- Stack window
- Symbols window.

Additional windows are available depending on which C-SPY driver you are using.

## Images window

The **Images** window is available from the **View** menu.

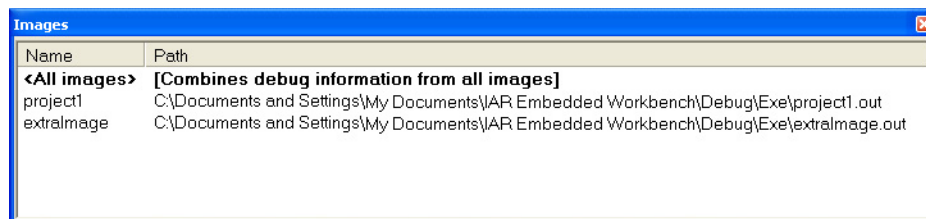

This window lists all currently loaded images (debug files).

Normally, a source application consists of exactly one image that you debug. However, you can also load additional images. This means that the complete debuggable unit consists of several images. See also *Loading multiple images*, page 41.

### Requirements

None; this window is always available.

### Display area

C-SPY can either use debug information from all of the loaded images simultaneously, or from one image at a time. Double-click on a row to show information only for that image. The current choice is highlighted.

This area lists the loaded images in these columns:

#### **Name**

The name of the loaded image.

#### **Path**

The path to the loaded image.

### Context menu

This context menu is available:



These commands are available:

#### Show all images

Shows debug information for all loaded debug images.

#### Show only *image*

Shows debug information for the selected debug image.

### Related information

For related information, see:

- *Loading multiple images*, page 41
- *Images*, page 325
- *\_\_loadImage*, page 277.

## Get Alternative File dialog box

The **Get Alternative File** dialog box is displayed if C-SPY cannot automatically find the source files to be loaded, for example if the application was built on another computer.

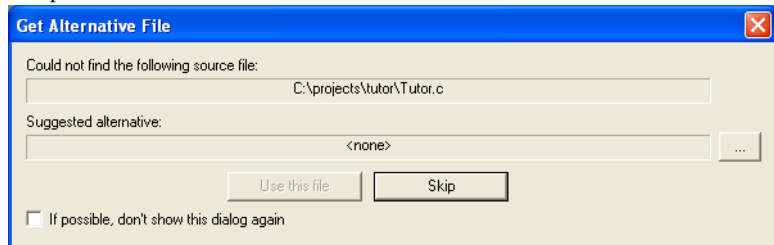

See also *Starting a debug session with source files missing*, page 40.

### Could not find the following source file

The missing source file.

### Suggested alternative

Specify an alternative file.

**Use this file**

After you have specified an alternative file, **Use this file** establishes that file as the alias for the requested file. Note that after you have chosen this action, C-SPY will automatically locate other source files if these files reside in a directory structure similar to the first selected alternative file.

The next time you start a debug session, the selected alternative file will be preloaded automatically.

**Skip**

C-SPY will assume that the source file is not available for this debug session.

**If possible, don't show this dialog again**

Instead of displaying the dialog box again for a missing source file, C-SPY will use the previously supplied response.

**Related information**

For related information, see *Starting a debug session with source files missing*, page 40.

## Option Bytes dialog box

The **Option Bytes** dialog box is available from the C-SPY driver menu.

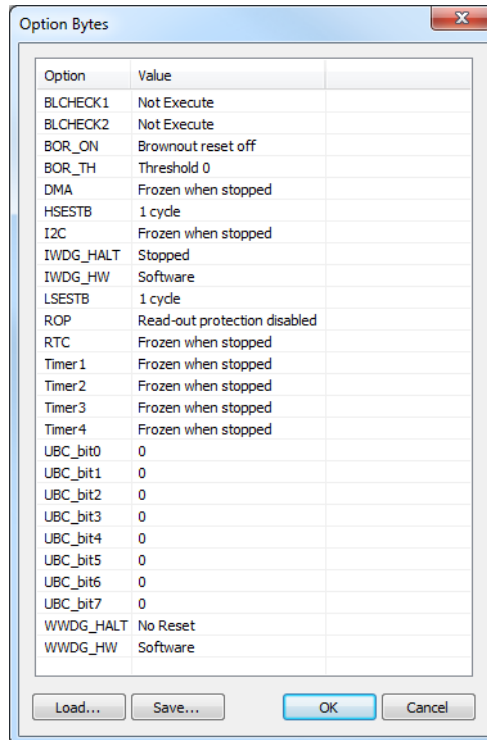

This dialog box lists all MCU options present at the target device together with their current values.



If you need the MCU options to be in effect before the target starts executing, you must deselect the **Run to** option on the **Project>Options>Debugger** page.

For information about setting option bytes in your source code, see *Setting option bytes*, page 44.

For more information about the option bytes and their possible values, see the data sheet for your device.

### Requirements

- The C-SPY ST-LINK driver
- The C-SPY STIcE driver.

**Display area****Option**

The name of the option byte.

**Value**

The current value of the option byte.

**Note:** Not all option bytes can be modified. ROP is one such option byte.

**Context menu**

Lists the possible values of the selected option byte. To modify a value, select it on this menu.

**Buttons****Load**

Loads an option bytes configuration file (obc) and shows the settings in the display area.

**Save**

Stores the settings made in the display area to an option bytes configuration file (obc).

**OK**

Writes the settings made in the display area to the target device.



# Executing your application

- Introduction to application execution
- Reference information on application execution

---

## Introduction to application execution

These topics are covered:

- Briefly about application execution
- Source and disassembly mode debugging
- Single stepping
- Troubleshooting slow stepping speed
- Running the application
- Highlighting
- Viewing the call stack
- Terminal input and output
- Debug logging

### BRIEFLY ABOUT APPLICATION EXECUTION

C-SPY allows you to monitor and control the execution of your application. By single-stepping through it, and setting breakpoints, you can examine details about the application execution, for example the values of variables and registers. You can also use the call stack to step back and forth in the function call chain.

The terminal I/O and debug log features let you interact with your application.

You can find commands for execution on the **Debug** menu and on the toolbar.

### SOURCE AND DISASSEMBLY MODE DEBUGGING

C-SPY allows you to switch between source mode and disassembly mode debugging as needed.

Source debugging provides the fastest and easiest way of developing your application, without having to worry about how the compiler or assembler has implemented the code. In the editor windows you can execute the application one statement at a time while monitoring the values of variables and data structures.

Disassembly mode debugging lets you focus on the critical sections of your application, and provides you with precise control of the application code. You can open a disassembly window which displays a mnemonic assembler listing of your application based on actual memory contents rather than source code, and lets you execute the application exactly one machine instruction at a time.

Regardless of which mode you are debugging in, you can display registers and memory, and change their contents.

## SINGLE STEPPING

C-SPY allows more stepping precision than most other debuggers because it is not line-oriented but statement-oriented. The compiler generates detailed stepping information in the form of *step points* at each statement, and at each function call. That is, source code locations where you might consider whether to execute a step into or a step over command. Because the step points are located not only at each statement but also at each function call, the step functionality allows a finer granularity than just stepping on statements.

There are several factors that can slow down the stepping speed. If you find it too slow, see *Troubleshooting slow stepping speed*, page 58 for some tips.

### The step commands

There are four step commands:

- **Step Into**
- **Step Over**
- **Next Statement**
- **Step Out.**

Using the **Autostep settings** dialog box, you can automate the single stepping. For more information, see *Autostep settings dialog box*, page 74.



Consider this example and assume that the previous step has taken you to the  $f(i)$  function call (highlighted):

```
extern int g(int);
int f(int n)
{
    value = g(n-1) + g(n-2) + g(n-3);
    return value;
}
int main()
{
    ...
    f(i);
    value ++;
}
```



### Step Into

While stepping, you typically consider whether to step into a function and continue stepping inside the function or subroutine. The **Step Into** command takes you to the first step point within the subroutine  $g(n-1)$ :

```
extern int g(int);
int f(int n)
{
    value = g(n-1) + g(n-2) + g(n-3);
    return value;
}
```

The **Step Into** command executes to the next step point in the normal flow of control, regardless of whether it is in the same or another function.



### Step Over

The **Step Over** command executes to the next step point in the same function, without stopping inside called functions. The command would take you to the  $g(n-2)$  function call, which is not a statement on its own but part of the same statement as  $g(n-1)$ . Thus, you can skip uninteresting calls which are parts of statements and instead focus on critical parts:

```
extern int g(int);
int f(int n)
{
    value = g(n-1) + g(n-2) + g(n-3);
    return value;
}
```



### Next Statement

The **Next Statement** command executes directly to the next statement, in this case `return value`, allowing faster stepping:

```
extern int g(int);
int f(int n)
{
    value = g(n-1) + g(n-2) + g(n-3);
    return value;
}
```



### Step Out

When inside the function, you can—if you wish—use the **Step Out** command to step out of it before it reaches the exit. This will take you directly to the statement immediately after the function call:

```
extern int g(int);
int f(int n)
{
    value = g(n-1) + g(n-2) g(n-3);
    return value;
}
int main()
{
    ...
    f(i);
    value ++;
}
```

The possibility of stepping into an individual function that is part of a more complex statement is particularly useful when you use C code containing many nested function calls. It is also very useful for C++, which tends to have many implicit function calls, such as constructors, destructors, assignment operators, and other user-defined operators.

This detailed stepping can in some circumstances be either invaluable or unnecessarily slow. For this reason, you can also step only on statements, which means faster stepping.

## TROUBLESHOOTING SLOW STEPPING SPEED

If you find that stepping speed is slow, these troubleshooting tips might speed up stepping:

- If you are using a hardware debugger system, keep track of how many hardware breakpoints that are used and make sure some of them are left for stepping.

Stepping in C-SPY is normally performed using breakpoints. When C-SPY performs a step command, a breakpoint is set on the next statement and the application executes until it reaches this breakpoint. If you are using a hardware debugger system, the number of hardware breakpoints—typically used for setting a stepping breakpoint in code that is located in flash/ROM memory—is limited. If you, for example, step into a `C switch` statement, breakpoints are set on each branch; this might consume several hardware breakpoints. If the number of available hardware breakpoints is exceeded, C-SPY switches into single stepping on assembly level, which can be very slow.

For more information, see *Breakpoints in the C-SPY hardware debugger drivers*, page 104 and *Breakpoint consumers*, page 105.

- Disable trace data collection, using the **Enable/Disable** button in both the **Trace** and the **Function Profiling** windows. Trace data collection might slow down stepping because the collected trace data is processed after each step. Note that it is not sufficient to just close the corresponding windows to disable trace data collection.
- Choose to view only a limited selection of SFR registers. You can choose between two alternatives. Either type `#SFR_name` (where `SFR_name` reflects the name of the SFR you want to monitor) in the **Watch** window, or create your own filter for displaying a limited group of SFRs in the **Registers** window. Displaying many SFR registers might slow down stepping because all registers must be read from the hardware after each step. See *Defining application-specific register groups*, page 130.
- Close the **Memory** and **Symbolic Memory** windows if they are open, because the visible memory must be read after each step and that might slow down stepping.
- Close any window that displays expressions such as **Watch**, **Live Watch**, **Locals**, **Statics** if it is open, because all these windows read memory after each step and that might slow down stepping.
- Close the **Stack** window if it is open. Choose **Tools>Options>Stack** and disable the **Enable graphical stack display and stack usage tracking** option if it is enabled.
- If possible, increase the communication speed between C-SPY and the target board/emulator.

## RUNNING THE APPLICATION

### Go



The **Go** command continues execution from the current position until a breakpoint or program exit is reached.



## Run to Cursor

The **Run to Cursor** command executes to the position in the source code where you have placed the cursor. The **Run to Cursor** command also works in the **Disassembly** window and in the **Call Stack** window.

## HIGHLIGHTING

At each stop, C-SPY highlights the corresponding C or C++ source or instruction with a green color, in the editor and the **Disassembly** window respectively. In addition, a green arrow appears in the editor window when you step on C or C++ source level, and in the **Disassembly** window when you step on disassembly level. This is determined by which of the windows is the active window. If none of the windows are active, it is determined by which of the windows was last active.

```
Tutor.c Utilities.c
void init_fib( void )
{
  int i = 45;
  root[0] = root[1] = 1;
  for ( i=2 ; i<MAX_FIB ; i++)
  {
```

For simple statements without function calls, the whole statement is typically highlighted. When stopping at a statement with function calls, C-SPY highlights the first call because this illustrates more clearly what **Step Into** and **Step Over** would mean at that time.

Occasionally, you will notice that a statement in the source window is highlighted using a pale variant of the normal highlight color. This happens when the program counter is at an assembler instruction which is part of a source statement but not exactly at a step point. This is often the case when stepping in the **Disassembly** window. Only when the program counter is at the first instruction of the source statement, the ordinary highlight color is used.

## VIEWING THE CALL STACK

The compiler generates extensive call frame information. This allows C-SPY to show, without any runtime penalty, the complete function call chain at any time.

Typically, this is useful for two purposes:



- Determining in what context the current function has been called
- Tracing the origin of incorrect values in variables and in parameters, thus locating the function in the call chain where the problem occurred.

The **Call Stack** window shows a list of function calls, with the current function at the top. When you inspect a function in the call chain, the contents of all affected windows

are updated to display the state of that particular call frame. This includes the editor, **Locals**, **Register**, **Watch**, and **Disassembly** windows. A function would normally not make use of all registers, so these registers might have undefined states and be displayed as dashes (---).

In the editor and **Disassembly** windows, a green highlight indicates the topmost, or current, call frame; a yellow highlight is used when inspecting other frames.

For your convenience, it is possible to select a function in the call stack and click the **Run to Cursor** command to execute to that function.

Assembler source code does not automatically contain any call frame information. To see the call chain also for your assembler modules, you can add the appropriate `CFI` assembler directives to the assembler source code. For more information, see the *IAR Assembler Reference Guide for STM8*.

## TERMINAL INPUT AND OUTPUT

Sometimes you might have to debug constructions in your application that use `stdin` and `stdout` without an actual hardware device for input and output. The **Terminal I/O** window lets you enter input to your application, and display output from it. You can also direct terminal I/O to a file, using the **Terminal I/O Log Files** dialog box.



This facility is useful in two different contexts:

- If your application uses `stdin` and `stdout`
- For producing debug trace printouts.

For more information, see *Terminal I/O window*, page 69 and *Terminal I/O Log File dialog box*, page 70.

## DEBUG LOGGING

The **Debug Log** window displays debugger output, such as diagnostic messages, macro-generated output, and information about trace.



It can sometimes be convenient to log the information to a file where you can easily inspect it, see *Log File dialog box*, page 72. The two main advantages are:

- The file can be opened in another tool, for instance an editor, so you can navigate and search within the file for particularly interesting parts
- The file provides history about how you have controlled the execution, for instance, which breakpoints that have been triggered etc.

---

## Reference information on application execution

Reference information about:

- *Disassembly window*, page 63
- *Call Stack window*, page 67
- *Terminal I/O window*, page 69
- *Terminal I/O Log File dialog box*, page 70
- *Debug Log window*, page 71
- *Log File dialog box*, page 72
- *Report Assert dialog box*, page 73
- *Autostep settings dialog box*, page 74
- *Cores window*, page 74

See also Terminal I/O options in the *IDE Project Management and Building Guide for STM8*.

## Disassembly window

The C-SPY **Disassembly** window is available from the **View** menu.

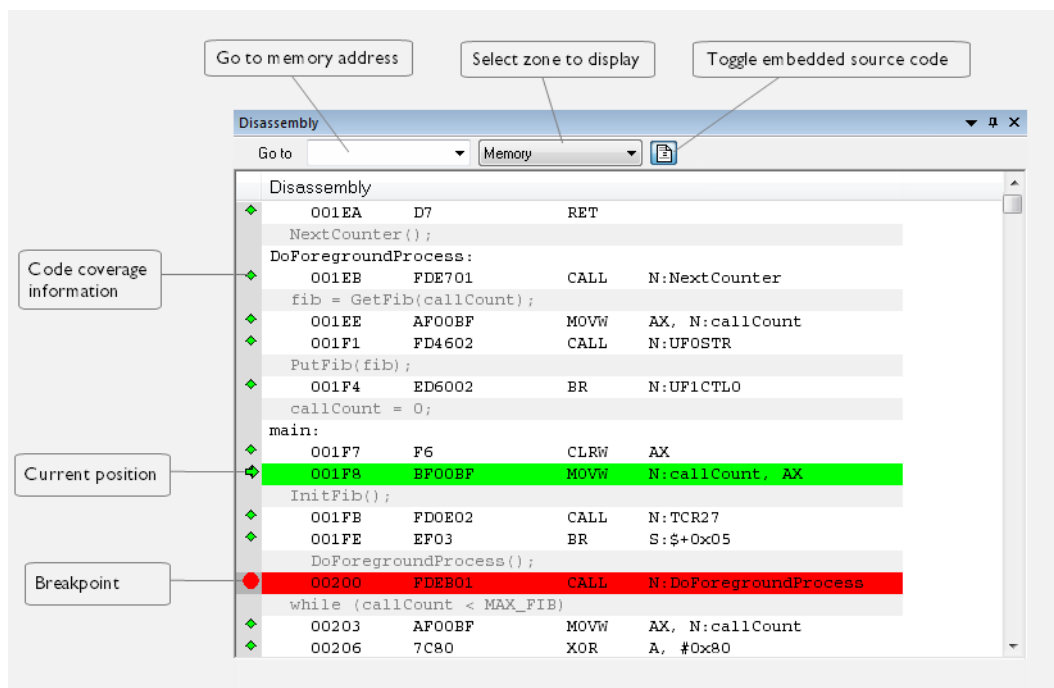

This window shows the application being debugged as disassembled application code.

**To change the default color of the source code in the Disassembly window:**

- 1 Choose **Tools>Options>Debugger**.
- 2 Set the default color using the **Source code coloring in disassembly window** option.



To view the corresponding assembler code for a function, you can select it in the editor window and drag it to the **Disassembly** window.

See also *Source and disassembly mode debugging*, page 55.

### Requirements

None; this window is always available.

## Toolbar

The toolbar contains:

### Go to

The memory location or symbol you want to view.

### Zone

Selects a memory zone, see *C-SPY memory zones*, page 128.

### Toggle Mixed-Mode

Toggles between displaying only disassembled code or disassembled code together with the corresponding source code. Source code requires that the corresponding source file has been compiled with debug information

## Display area

The display area shows the disassembled application code.

This area contains these graphic elements:

Green highlight	Indicates the current position, that is the next assembler instruction to be executed. To move the cursor to any line in the <b>Disassembly</b> window, click the line. Alternatively, move the cursor using the navigation keys.
Yellow highlight	Indicates a position other than the current position, such as when navigating between frames in the <b>Call Stack</b> window or between items in the <b>Trace</b> window.
Red dot	Indicates a breakpoint. Double-click in the gray left-side margin of the window to set a breakpoint. For more information, see <i>Breakpoints</i> , page 101.
Green diamond	Indicates code that has been executed—that is, code coverage.

If instruction profiling has been enabled from the context menu, an extra column in the left-side margin appears with information about how many times each instruction has been executed.



## Context menu

This context menu is available:

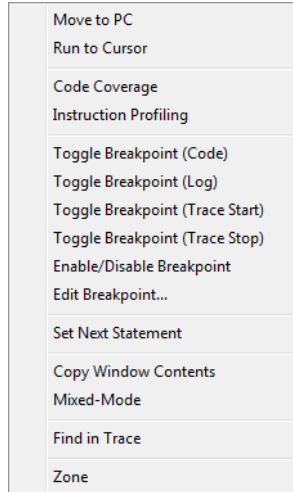

**Note:** The contents of this menu are dynamic, which means that the commands on the menu might depend on your product package.

These commands are available:

### Move to PC

Displays code at the current program counter location.

### Run to Cursor

Executes the application from the current position up to the line containing the cursor.

### Code Coverage

Displays a submenu that provides commands for controlling code coverage. This command is only enabled if the driver you are using supports it.

<b>Enable</b>	Toggles code coverage on or off.
<b>Show</b>	Toggles the display of code coverage on or off. Executed code is indicated by a green diamond.
<b>Clear</b>	Clears all code coverage information.

**Instruction Profiling**

Displays a submenu that provides commands for controlling instruction profiling. This command is only enabled if the driver you are using supports it.

<b>Enable</b>	Toggles instruction profiling on or off.
<b>Show</b>	Toggles the display of instruction profiling on or off. For each instruction, the left-side margin displays how many times the instruction has been executed.
<b>Clear</b>	Clears all instruction profiling information.

**Toggle Breakpoint (Code)**

Toggles a code breakpoint. Assembler instructions and any corresponding label at which code breakpoints have been set are highlighted in red. For more information, see *Code breakpoints dialog box*, page 117.

**Toggle Breakpoint (Log)**

Toggles a log breakpoint for trace printouts. Assembler instructions at which log breakpoints have been set are highlighted in red. For more information, see *Log breakpoints dialog box*, page 119.

**Toggle Breakpoint (Trace Start)**

Toggles a Trace Start breakpoint. When the breakpoint is triggered, the trace data collection starts. Note that this menu command is only available if the C-SPY driver you are using supports trace. For more information, see *Trace Start breakpoints dialog box*, page 176.

**Toggle Breakpoint (Trace Stop)**

Toggles a Trace Stop breakpoint. When the breakpoint is triggered, the trace data collection stops. Note that this menu command is only available if the C-SPY driver you are using supports trace. For more information, see *Trace Stop breakpoints dialog box*, page 177.

**Enable/Disable Breakpoint**

Enables and Disables a breakpoint. If there is more than one breakpoint at a specific line, all those breakpoints are affected by the **Enable/Disable** command.

**Edit Breakpoint**

Displays the breakpoint dialog box to let you edit the currently selected breakpoint. If there is more than one breakpoint on the selected line, a submenu is displayed that lists all available breakpoints on that line.

**Set Next Statement**

Sets the program counter to the address of the instruction at the insertion point.

### Copy Window Contents

Copies the selected contents of the **Disassembly** window to the clipboard.

### Mixed-Mode

Toggles between showing only disassembled code or disassembled code together with the corresponding source code. Source code requires that the corresponding source file has been compiled with debug information.

### Find in Trace

Searches the contents of the **Trace** window for occurrences of the given location—the position of the insertion point in the source code—and reports the result in the **Find in Trace** window. This menu command requires support for Trace in the C-SPY driver you are using, see *Differences between the C-SPY drivers*, page 33.

### Zone

Selects a memory zone, see *C-SPY memory zones*, page 128.

## Call Stack window

The **Call Stack** window is available from the **View** menu.

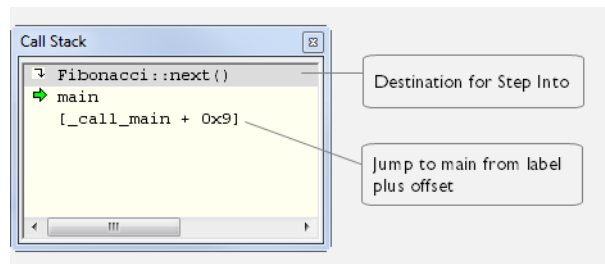

This window displays the C function call stack with the current function at the top. To inspect a function call, double-click it. C-SPY now focuses on that call frame instead.

If the next **Step Into** command would step to a function call, the name of the function is displayed in the gray bar at the top of the window. This is especially useful for implicit function calls, such as C++ constructors, destructors, and operators.

See also *Viewing the call stack*, page 60.

### Requirements

None; this window is always available.

## Display area

Each entry in the display area is formatted in one of these ways:

<code>function(values)***</code>	A C/C++ function with debug information.  Provided that <b>Show Arguments</b> is enabled, <i>values</i> is a list of the current values of the parameters, or empty if the function does not take any parameters.  ***, if present, indicates that the function has been inlined by the compiler. For information about function inlining, see the <i>IAR C/C++ Development Guide for STM8</i> .
<code>[label + offset]</code>	An assembler function, or a C/C++ function without debug information.
<code>&lt;exception_frame&gt;</code>	An interrupt.

## Context menu

This context menu is available:

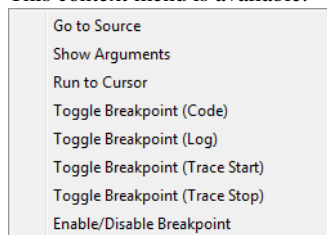

These commands are available:

### Go to Source

Displays the selected function in the **Disassembly** or editor windows.

### Show Arguments

Shows function arguments.

### Run to Cursor

Executes until return to the function selected in the call stack.

### Toggle Breakpoint (Code)

Toggles a code breakpoint.

### Toggle Breakpoint (Log)

Toggles a log breakpoint.

**Toggle Breakpoint (Trace Start)**

Toggles a Trace Start breakpoint. When the breakpoint is triggered, trace data collection starts. Note that this menu command is only available if the C-SPY driver you are using supports it.

**Toggle Breakpoint (Trace Stop)**

Toggles a Trace Stop breakpoint. When the breakpoint is triggered, trace data collection stops. Note that this menu command is only available if the C-SPY driver you are using supports it.

**Enable/Disable Breakpoint**

Enables or disables the selected breakpoint

## Terminal I/O window

The **Terminal I/O** window is available from the **View** menu.

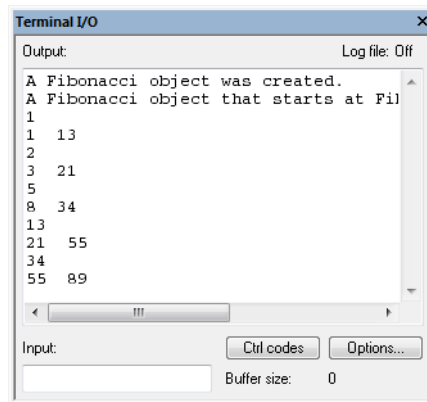

Use this window to enter input to your application, and display output from it.

**To use this window, you must:**

- I Link your application with the option **Include C-SPY debugging support**.

C-SPY will then direct `stdin`, `stdout` and `stderr` to this window. If the **Terminal I/O** window is closed, C-SPY will open it automatically when input is required, but not for output.

See also *Terminal input and output*, page 61.

**Requirements**

None; this window is always available.

**Input**

Type the text that you want to input to your application.

**Ctrl codes**

Opens a menu for input of special characters, such as EOF (end of file) and NUL.

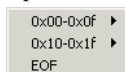
**Options**

Opens the **IDE Options** dialog box where you can set options for terminal I/O. For reference information about the options available in this dialog box, see *Terminal I/O options* in *IDE Project Management and Building Guide for STM8*.

**Terminal I/O Log File dialog box**

The **Terminal I/O Log File** dialog box is available by choosing **Debug>Logging>Set Terminal I/O Log File**.

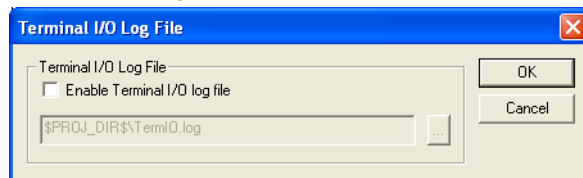

Use this dialog box to select a destination log file for terminal I/O from C-SPY.

See also *Terminal input and output*, page 61.

**Requirements**

None; this dialog box is always available.

**Terminal IO Log Files**

Controls the logging of terminal I/O. To enable logging of terminal I/O to a file, select **Enable Terminal IO log file** and specify a filename. The default filename extension is `log`. A browse button is available for your convenience.

## Debug Log window

The **Debug Log** window is available by choosing **View>Messages**.

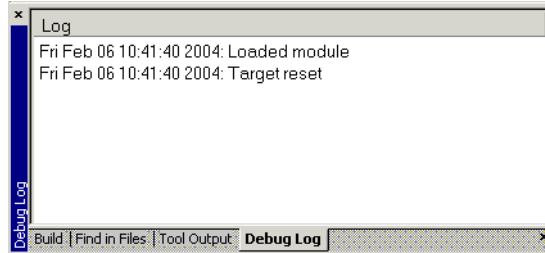

This window displays debugger output, such as diagnostic messages, macro-generated output, and information about trace. This output is only available during a debug session. When opened, this window is, by default, grouped together with the other message windows, see *IDE Project Management and Building Guide for STM8*.

Double-click any rows in one of the following formats to display the corresponding source code in the editor window:

```
<path> (<row>) :<message>
<path> (<row>,<column>) :<message>
```

See also *Debug logging*, page 61 and *Log File dialog box*, page 72.

### Requirements

None; this window is always available.

### Context menu

This context menu is available:

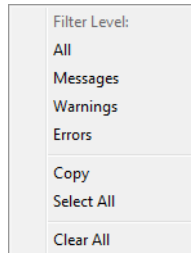

These commands are available:

#### All

Shows all messages sent by the debugging tools and drivers.

### Messages

Shows all C-SPY messages.

### Warnings

Shows warnings and errors.

### Errors

Shows errors only.

### Copy

Copies the contents of the window.

### Select All

Selects the contents of the window.

### Clear All

Clears the contents of the window.

## Log File dialog box

The **Log File** dialog box is available by choosing **Debug>Logging>Set Log File**.

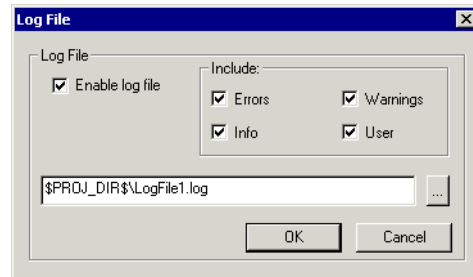

Use this dialog box to log output from C-SPY to a file.

### Requirements

None; this dialog box is always available.

### Enable Log file

Enables or disables logging to the file.

### Include

The information printed in the file is, by default, the same as the information listed in the Log window. Use the browse button, to override the default file and location of the



log file (the default filename extension is `log`). To change the information logged, choose between:

#### Errors

C-SPY has failed to perform an operation.

#### Warnings

An error or omission of concern.

#### Info

Progress information about actions C-SPY has performed.

#### User

Messages from C-SPY macros, that is, your messages using the `__message` statement.

## Report Assert dialog box

The **Report Assert dialog box** appears if you have a call to the `assert` function in your application source code, and the assert condition is false. In this dialog box you can choose how to proceed.

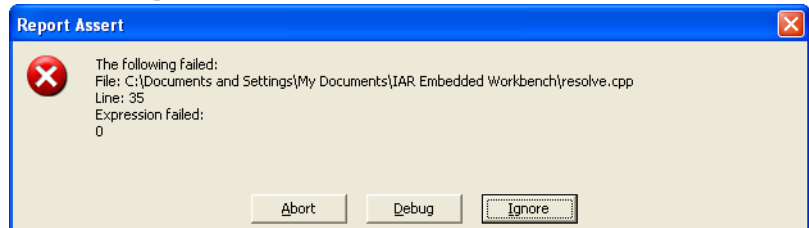

#### Abort

The application stops executing and the runtime library function `abort`, which is part of your application on the target system, will be called. This means that the application itself terminates its execution.

#### Debug

C-SPY stops the execution of the application and returns control to you.

#### Ignore

The assertion is ignored and the application continues to execute.

## Autostep settings dialog box

The **Autostep settings** dialog box is available from the **Debug** menu.

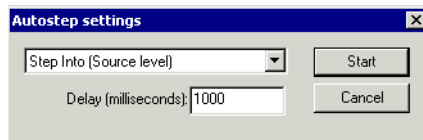

Use this dialog box to customize autostepping.

The drop-down menu lists the available step commands, see *Single stepping*, page 56.

### Requirements

None; this dialog box is always available.

### Delay

Specify the delay between each step in milliseconds.

## Cores window

The **Cores** window is available from the **View** menu.

Cores				
Core	Status	PC	Cycles	
 0: Core 0	Stopped	0xE0055F	74	

This window displays information about the executing core, such as its execution state. This information is primarily useful for IAR Embedded Workbench products that support multicore debugging.

### Requirements

None; this window is always available.

### Display area





A row in this area shows information about a core, in these columns:

#### *Execution state*

Displays one of these icons to indicate the execution state of the core.



in focus, not executing

	not in focus, not executing
	in focus, executing
	not in focus, executing
	in focus, in sleep mode
	not in focus, in sleep mode

**Core**

The name of the core.

**Status**

The status of the execution, which can be one of **Stopped**, **Running**, or **Sleeping**.

**PC**

The value of the program counter.

**Cycles | Time**

The value of the cycle counter or the execution time since the start of the execution, depending on the debugger driver you are using.



# Variables and expressions

- Introduction to working with variables and expressions
- Working with variables and expressions
- Reference information on working with variables and expressions

---

## Introduction to working with variables and expressions

This section introduces different methods for looking at variables and introduces some related concepts.

These topics are covered:

- Briefly about working with variables and expressions
- C-SPY expressions
- Limitations on variable information.

### BRIEFLY ABOUT WORKING WITH VARIABLES AND EXPRESSIONS

There are several methods for looking at variables and calculating their values. These methods are suitable for basic debugging:

- **Tooltip watch**—in the editor window—provides the simplest way of viewing the value of a variable or more complex expressions. Just point at the variable with the mouse pointer. The value is displayed next to the variable.
- The **Auto** window displays a useful selection of variables and expressions in, or near, the current statement. The window is automatically updated when execution stops.
- The **Locals** window displays the local variables, that is, auto variables and function parameters for the active function. The window is automatically updated when execution stops.
- The **Watch** window allows you to monitor the values of C-SPY expressions and variables. The window is automatically updated when execution stops.
- The **Live Watch** window repeatedly samples and displays the values of expressions while your application is executing. Variables in the expressions must be statically located, such as global variables.
- The **Statics** window displays the values of variables with static storage duration. The window is automatically updated when execution stops.

- The **Macro Quicklaunch** window and the **Quick Watch** window give you precise control over when to evaluate an expression.
- The **Symbols** window displays all symbols with a static location, that is, C/C++ functions, assembler labels, and variables with static storage duration, including symbols from the runtime library.

These additional methods for looking at variables are suitable for more advanced analysis:

- The **Data Log** window and the **Data Log Summary** window display logs of accesses to up to four different memory locations you choose by setting data log breakpoints. Data logging can help you locate frequently accessed data. You can then consider whether you should place that data in more efficient memory.
- The **Data Sample** window displays samples for up to four different variables. You can also display the data samples as graphs in the **Sampled Graphs** window. By using data sampling, you will get an indication of the data value over a length of time. Because it is a sampled value, data sampling is best suited for slow-changing data.

For more information about these windows, see *Trace*, page 165.

## C-SPY EXPRESSIONS

C-SPY expressions can include any type of C expression, except for calls to functions. The following types of symbols can be used in expressions:

- C/C++ symbols
- Assembler symbols (register names and assembler labels)
- C-SPY macro functions
- C-SPY macro variables.

Expressions that are built with these types of symbols are called C-SPY expressions and there are several methods for monitoring these in C-SPY. Examples of valid C-SPY expressions are:

```
i + j
i = 42
myVar = cVar
cVar = myVar + 2
#asm_label
#R2
#PC
my_macro_func(19)
```

If you have a static variable with the same name declared in several different functions, use the notation *function::variable* to specify which variable to monitor.

## C/C++ symbols

C symbols are symbols that you have defined in the C source code of your application, for instance variables, constants, and functions (functions can be used as symbols but cannot be executed). C symbols can be referenced by their names. Note that C++ symbols might implicitly contain function calls which are not allowed in C-SPY symbols and expressions.

**Note:** Some attributes available in C/C++, like `volatile`, are not fully supported by C-SPY. For example, this line will not be accepted by C-SPY:

```
sizeof(unsigned char volatile __memattr *)
```

However, this line will be accepted:

```
sizeof(unsigned char __memattr *)
```

## Assembler symbols

Assembler symbols can be assembler labels or registers, for example the program counter, the stack pointer, or other CPU registers. If a device description file is used, all memory-mapped peripheral units, such as I/O ports, can also be used as assembler symbols in the same way as the CPU registers. See *Modifying a device description file*, page 43.

Assembler symbols can be used in C-SPY expressions if they are prefixed by #.

Example	What it does
#PC++	Increments the value of the program counter.
myVar = #SP	Assigns the current value of the stack pointer register to your C-SPY variable.
myVar = #label	Sets myVar to the value of an integer at the address of label.
myptr = &#label7	Sets myptr to an int * pointer pointing at label7.

Table 4: C-SPY assembler symbols expressions

In case of a name conflict between a hardware register and an assembler label, hardware registers have a higher precedence. To refer to an assembler label in such a case, you must enclose the label in back quotes ` (ASCII character 0x60). For example:

Example	What it does
#PC	Refers to the program counter.
#`PC`	Refers to the assembler label PC.

Table 5: Handling name conflicts between hardware registers and assembler labels

Which processor-specific symbols are available by default can be seen in the **Registers** window, using the CPU Registers register group. See *Registers window*, page 148.

## C-SPY macro functions

Macro functions consist of C-SPY macro variable definitions and macro statements which are executed when the macro is called.

For information about C-SPY macro functions and how to use them, see *Briefly about the macro language*, page 254.

## C-SPY macro variables

Macro variables are defined and allocated outside your application, and can be used in a C-SPY expression. In case of a name conflict between a C symbol and a C-SPY macro variable, the C-SPY macro variable will have a higher precedence than the C variable. Assignments to a macro variable assign both its value and type.

For information about C-SPY macro variables and how to use them, see *Reference information on the macro language*, page 260.

## Using sizeof

According to standard C, there are two syntactical forms of `sizeof`:

```
sizeof(type)
sizeof expr
```

The former is for types and the latter for expressions.

**Note:** In C-SPY, do not use parentheses around an expression when you use the `sizeof` operator. For example, use `sizeof x+2` instead of `sizeof (x+2)`.

## LIMITATIONS ON VARIABLE INFORMATION

The value of a C variable is valid only on step points, that is, the first instruction of a statement and on function calls. This is indicated in the editor window with a bright green highlight color. In practice, the value of the variable is accessible and correct more often than that.

When the program counter is inside a statement, but not at a step point, the statement or part of the statement is highlighted with a pale variant of the ordinary highlight color.

## Effects of optimizations

The compiler is free to optimize the application software as much as possible, as long as the expected behavior remains. The optimization can affect the code so that debugging might be more difficult because it will be less clear how the generated code relates to the source code. Typically, using a high optimization level can affect the code in a way that will not allow you to view a value of a variable as expected.



Consider this example:

```
myFunction()
{
    int i = 42;
    ...
    x = computer(i); /* Here, the value of i is known to C-SPY */
    ...
}
```

From the point where the variable `i` is declared until it is actually used, the compiler does not need to waste stack or register space on it. The compiler can optimize the code, which means that C-SPY will not be able to display the value until it is actually used. If you try to view the value of a variable that is temporarily unavailable, C-SPY will display the text:

Unavailable

If you need full information about values of variables during your debugging session, you should make sure to use the lowest optimization level during compilation, that is, **None**.

---

## Working with variables and expressions

These tasks are covered:

- Using the windows related to variables and expressions
- Viewing assembler variables

See also *Analyzing your application's timeline*, page 185.

### USING THE WINDOWS RELATED TO VARIABLES AND EXPRESSIONS

Where applicable, you can add, modify, and remove expressions, and change the display format in the windows related to variables and expressions.

To add a value you can also click in the dotted rectangle and type the expression you want to examine. To modify the value of an expression, click the **Value** field and modify its content. To remove an expression, select it and press the Delete key.



For text that is too wide to fit in a column—in any of these windows, except the **Trace** window—and thus is truncated, just point at the text with the mouse pointer and tooltip information is displayed.

Right-click in any of the windows to access the context menu which contains additional commands. Convenient drag-and-drop between windows is supported, except for in the

**Locals** window, Data logging windows, and the **Quick Watch** window where it is not relevant.

## VIEWING ASSEMBLER VARIABLES

An assembler label does not convey any type information at all, which means C-SPY cannot easily display data located at that label without getting extra information. To view data conveniently, C-SPY by default treats all data located at assembler labels as variables of type `int`. However, in the **Watch**, **Live Watch**, and **Quick Watch** windows, you can select a different interpretation to better suit the declaration of the variables.

In this figure, you can see four variables in the **Watch** window and their corresponding declarations in the assembler source file to the left:

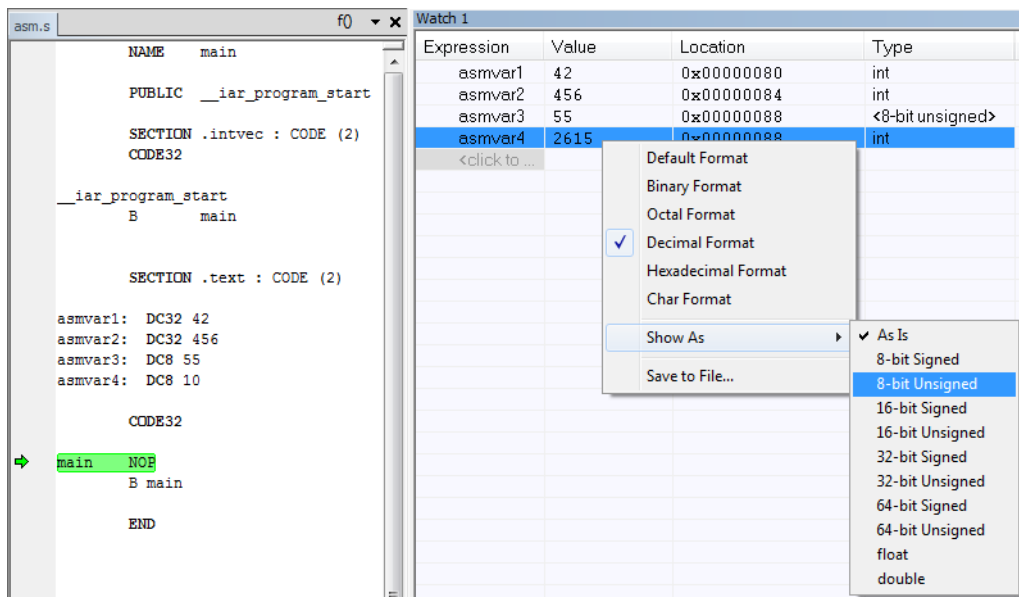

Note that `asmvar4` is displayed as an `int`, although the original assembler declaration probably intended for it to be a single byte quantity. From the context menu you can make C-SPY display the variable as, for example, an 8-bit unsigned variable. This has already been specified for the `asmvar3` variable.

## Reference information on working with variables and expressions

Reference information about:

- *Auto window*, page 83
- *Locals window*, page 85
- *Watch window*, page 87
- *Live Watch window*, page 90
- *Statics window*, page 92
- *Quick Watch window*, page 95
- *Symbols window*, page 98
- *Resolve Symbol Ambiguity dialog box*, page 99

See also:

- *Reference information on trace*, page 168 for trace-related reference information
- *Macro Quicklaunch window*, page 305

### Auto window

The **Auto** window is available from the **View** menu.

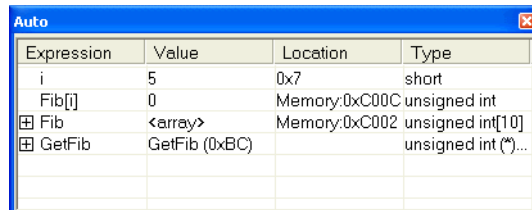

Expression	Value	Location	Type
i	5	0x7	short
Fib[i]	0	Memory:0xC00C	unsigned int
⊕ Fib	<array>	Memory:0xC002	unsigned int[10]
⊕ GetFib	GetFib (0xBC)		unsigned int (*)...

This window displays a useful selection of variables and expressions in, or near, the current statement. Every time execution in C-SPY stops, the values in the **Auto** window are recalculated. Values that have changed since the last stop are highlighted in red.

See also *Editing in C-SPY windows*, page 42.

### Requirements

None; this window is always available.

## Context menu

This context menu is available:

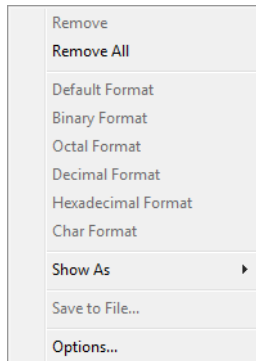

**Note:** The contents of this menu are dynamic and depend on which features that your combination of software and hardware supports. However, the list of menu commands below is complete and covers all possible commands.

These commands are available:

### Remove

Removes the selected expression from the window.

### Remove All

Removes all expressions listed in the window.

### Default Format, Binary Format, Octal Format, Decimal Format, Hexadecimal Format, Char Format

Changes the display format of expressions. The display format setting affects different types of expressions in different ways. Your selection of display format is saved between debug sessions. These commands are available if a selected line in the window contains a variable.

The display format setting affects different types of expressions in these ways:

Variables	The display setting affects only the selected variable, not other variables.
Array elements	The display setting affects the complete array, that is, the same display format is used for each array element.

Structure fields      All elements with the same definition—the same field name and C declaration type—are affected by the display setting.

### Show As

Displays a submenu that provides commands for changing the default type interpretation of variables. The commands on this submenu are mainly useful for assembler variables—data at assembler labels—because these are, by default, displayed as integers. For more information, see *Viewing assembler variables*, page 82.

### Options

Displays the **IDE Options** dialog box where you can set various options, for example the **Update interval** option. The default value of this option is 1000 milliseconds, which means the **Live Watch** window will be updated once every second during program execution.

### Save to File

Saves content to a file in a tab-separated format.

## Locals window

The **Locals** window is available from the **View** menu.

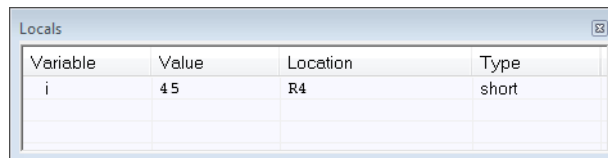

Variable	Value	Location	Type
i	45	R4	short

This window displays the local variables and parameters for the current function. Every time execution in C-SPY stops, the values in the window are recalculated. Values that have changed since the last stop are highlighted in red.

See also *Editing in C-SPY windows*, page 42.

### Requirements

None; this window is always available.

## Context menu

This context menu is available:

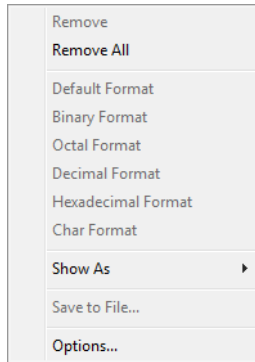

**Note:** The contents of this menu are dynamic and depend on which features that your combination of software and hardware supports. However, the list of menu commands below is complete and covers all possible commands.

These commands are available:

### Remove

Removes the selected expression from the window.

### Remove All

Removes all expressions listed in the window.

### Default Format, Binary Format, Octal Format, Decimal Format, Hexadecimal Format, Char Format

Changes the display format of expressions. The display format setting affects different types of expressions in different ways. Your selection of display format is saved between debug sessions. These commands are available if a selected line in the window contains a variable.

The display format setting affects different types of expressions in these ways:

Variables	The display setting affects only the selected variable, not other variables.
Array elements	The display setting affects the complete array, that is, the same display format is used for each array element.

Structure fields All elements with the same definition—the same field name and C declaration type—are affected by the display setting.

### Show As

Displays a submenu that provides commands for changing the default type interpretation of variables. The commands on this submenu are mainly useful for assembler variables—data at assembler labels—because these are, by default, displayed as integers. For more information, see *Viewing assembler variables*, page 82.

### Options

Displays the **IDE Options** dialog box where you can set various options, for example the **Update interval** option. The default value of this option is 1000 milliseconds, which means the **Live Watch** window will be updated once every second during program execution.

### Save to File

Saves content to a file in a tab-separated format.

## Watch window

The **Watch** window is available from the **View** menu.

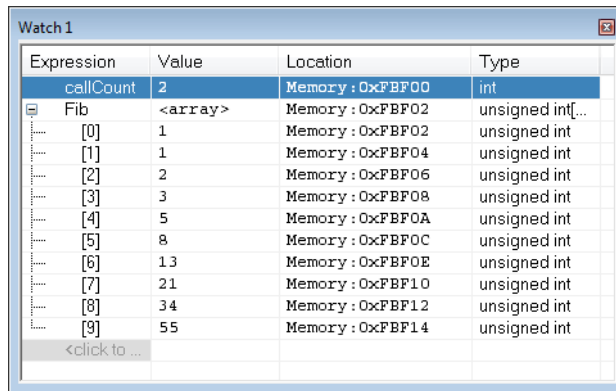

Expression	Value	Location	Type
callCount	2	Memory : 0xFBFB00	int
Fib	<array>	Memory : 0xFBFB02	unsigned int[...]
[0]	1	Memory : 0xFBFB02	unsigned int
[1]	1	Memory : 0xFBFB04	unsigned int
[2]	2	Memory : 0xFBFB06	unsigned int
[3]	3	Memory : 0xFBFB08	unsigned int
[4]	5	Memory : 0xFBFB0A	unsigned int
[5]	8	Memory : 0xFBFB0C	unsigned int
[6]	13	Memory : 0xFBFB0E	unsigned int
[7]	21	Memory : 0xFBFB10	unsigned int
[8]	34	Memory : 0xFBFB12	unsigned int
[9]	55	Memory : 0xFBFB14	unsigned int
<click to ...			

Use this window to monitor the values of C-SPY expressions or variables. You can open up to four instances of this window, where you can view, add, modify, and remove expressions. Tree structures of arrays, structs, and unions are expandable, which means that you can study each item of these.

Every time execution in C-SPY stops, the values in the **Watch** window are recalculated. Values that have changed since the last stop are highlighted in red.



Be aware that expanding very huge arrays can cause an out-of-memory crash. To avoid this, expansion is automatically performed in steps of 5000 elements.

See also *Editing in C-SPY windows*, page 42.

## Requirements

None; this window is always available.

## Context menu

This context menu is available:

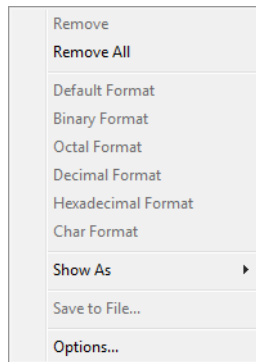

**Note:** The contents of this menu are dynamic and depend on which features that your combination of software and hardware supports. However, the list of menu commands below is complete and covers all possible commands.

These commands are available:

### Remove

Removes the selected expression from the window.

### Remove All

Removes all expressions listed in the window.



**Default Format,  
Binary Format,  
Octal Format,  
Decimal Format,  
Hexadecimal Format,  
Char Format**

Changes the display format of expressions. The display format setting affects different types of expressions in different ways. Your selection of display format is saved between debug sessions. These commands are available if a selected line in the window contains a variable.

The display format setting affects different types of expressions in these ways:

Variables	The display setting affects only the selected variable, not other variables.
Array elements	The display setting affects the complete array, that is, the same display format is used for each array element.
Structure fields	All elements with the same definition—the same field name and C declaration type—are affected by the display setting.

**Show As**

Displays a submenu that provides commands for changing the default type interpretation of variables. The commands on this submenu are mainly useful for assembler variables—data at assembler labels—because these are, by default, displayed as integers. For more information, see *Viewing assembler variables*, page 82.

**Options**

Displays the **IDE Options** dialog box where you can set various options, for example the **Update interval** option. The default value of this option is 1000 milliseconds, which means the **Live Watch** window will be updated once every second during program execution.

**Save to File**

Saves content to a file in a tab-separated format.

## Live Watch window

The **Live Watch** window is available from the **View** menu.

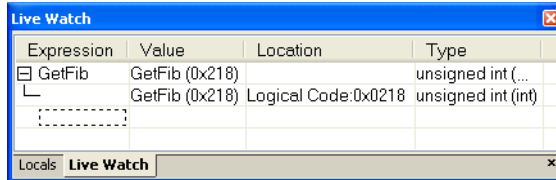

This window repeatedly samples and displays the value of expressions while your application is executing. Variables in the expressions must be statically located, such as global variables.

See also *Editing in C-SPY windows*, page 42.

### Requirements

None; this window is always available.

### Display area

This area contains these columns:

#### Expression

The name of the variable. The base name of the variable is followed by the full name, which includes module, class, or function scope. This column is not editable.

#### Value

The value of the variable. Values that have changed are highlighted in red.

Dragging text or a variable from another window and dropping it on the **Value** column will assign a new value to the variable in that row.

This column is editable.

#### Location

The location in memory where this variable is stored.

#### Type

The data type of the variable.

## Context menu

This context menu is available:

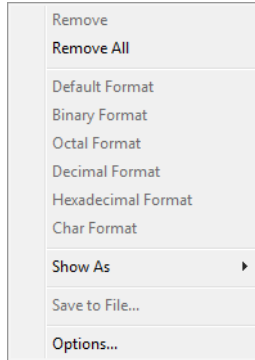

**Note:** The contents of this menu are dynamic and depend on which features that your combination of software and hardware supports. However, the list of menu commands below is complete and covers all possible commands.

These commands are available:

### **Remove**

Removes the selected expression from the window.

### **Remove All**

Removes all expressions listed in the window.

### **Default Format, Binary Format, Octal Format, Decimal Format, Hexadecimal Format, Char Format**

Changes the display format of expressions. The display format setting affects different types of expressions in different ways. Your selection of display format is saved between debug sessions. These commands are available if a selected line in the window contains a variable.

The display format setting affects different types of expressions in these ways:

Variables	The display setting affects only the selected variable, not other variables.
Array elements	The display setting affects the complete array, that is, the same display format is used for each array element.

Structure fields All elements with the same definition—the same field name and C declaration type—are affected by the display setting.

### Show As

Displays a submenu that provides commands for changing the default type interpretation of variables. The commands on this submenu are mainly useful for assembler variables—data at assembler labels—because these are, by default, displayed as integers. For more information, see *Viewing assembler variables*, page 82.

### Options

Displays the **IDE Options** dialog box where you can set various options, for example the **Update interval** option. The default value of this option is 1000 milliseconds, which means the **Live Watch** window will be updated once every second during program execution.

### Save to File

Saves content to a file in a tab-separated format.

## Statics window

The **Statics** window is available from the **View** menu.

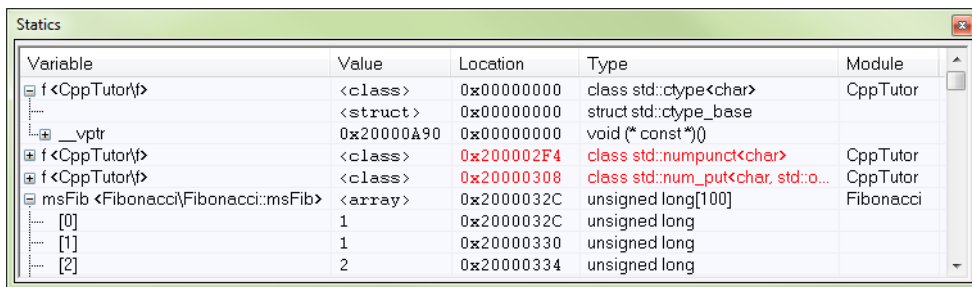

Variable	Value	Location	Type	Module
f <CppTutor\>	<class>	0x00000000	class std::ctype<char>	CppTutor
.....	<struct>	0x00000000	struct std::type_base	
.....	0x20000A90	0x00000000	void (* const*)()	
.....	.....	.....	.....	.....
f <CppTutor\>	<class>	0x200002F4	class std::num_punct<char>	CppTutor
f <CppTutor\>	<class>	0x20000308	class std::num_put<char, std::o...	CppTutor
msFib <Fibonacci\Fibonacci:msFib>	<array>	0x2000032C	unsigned long[100]	Fibonacci
..... [0]	1	0x2000032C	unsigned long	
..... [1]	1	0x20000330	unsigned long	
..... [2]	2	0x20000334	unsigned long	

This window displays the values of variables with static storage duration that you have selected. Typically, that is variables with file scope but it can also be static variables in functions and classes. Note that `volatile` declared variables with static storage duration will not be displayed.

Every time execution in C-SPY stops, the values in the **Statics** window are recalculated. Values that have changed since the last stop are highlighted in red.

Click any column header (except for **Value**) to sort on that column.

See also *Editing in C-SPY windows*, page 42.

### To select variables to monitor:

- 1 In the window, right-click and choose **Select statics** from the context menu. The window now lists all variables with static storage duration.
- 2 Either individually select the variables you want to display, or choose one of the **Select** commands from the context menu.
- 3 When you have made your selections, choose **Select statics** from the context menu to toggle back to normal display mode.

### Requirements

None; this window is always available.

### Display area

This area contains these columns:

#### Expression

The name of the variable. The base name of the variable is followed by the full name, which includes module, class, or function scope. This column is not editable.

#### Value

The value of the variable. Values that have changed are highlighted in red.

Dragging text or a variable from another window and dropping it on the **Value** column will assign a new value to the variable in that row.

This column is editable.

#### Location

The location in memory where this variable is stored.

#### Type

The data type of the variable.

#### Module

The module of the variable.

## Context menu

This context menu is available:

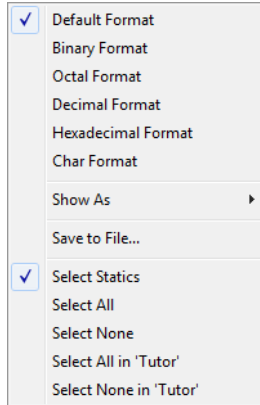

These commands are available:

### **Default Format, Binary Format, Octal Format, Decimal Format, Hexadecimal Format, Char Format**

Changes the display format of expressions. The display format setting affects different types of expressions in different ways. Your selection of display format is saved between debug sessions. These commands are available if a selected line in the window contains a variable.

The display format setting affects different types of expressions in these ways:

Variables	The display setting affects only the selected variable, not other variables.
Array elements	The display setting affects the complete array, that is, the same display format is used for each array element.
Structure fields	All elements with the same definition—the same field name and C declaration type—are affected by the display setting.

### **Save to File**

Saves the content of the **Statics** window to a log file.

**Select Statics**

Selects all variables with static storage duration; this command also enables all **Select** commands below. Select the variables you want to monitor. When you have made your selections, select this menu command again to toggle back to normal display mode.

**Select All**

Selects all variables.

**Select None**

Deselects all variables.

**Select All in *module***

Selects all variables in the selected module.

**Select None in *module***

Deselects all variables in the selected module.

## Quick Watch window

The **Quick Watch** window is available from the **View** menu and from the context menu in the editor window.

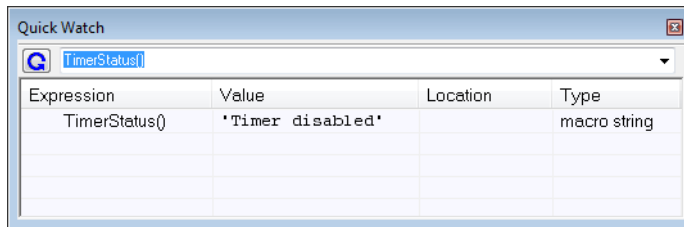

Use this window to watch the value of a variable or expression and evaluate expressions at a specific point in time.

In contrast to the **Watch** window, the **Quick Watch** window gives you precise control over when to evaluate the expression. For single variables this might not be necessary, but for expressions with possible side effects, such as assignments and C-SPY macro functions, it allows you to perform evaluations under controlled conditions.

See also *Editing in C-SPY windows*, page 42.

**To evaluate an expression:**

- 1 In the editor window, right-click on the expression you want to examine and choose **Quick Watch** from the context menu that appears.
- 2 The expression will automatically appear in the **Quick Watch** window.

Alternatively:

**3** In the **Quick Watch** window, type the expression you want to examine in the **Expressions** text box.



**4** Click the **Recalculate** button to calculate the value of the expression.

For an example, see *Using C-SPY macros*, page 255.

## Requirements

None; this window is always available.

## Context menu

This context menu is available:

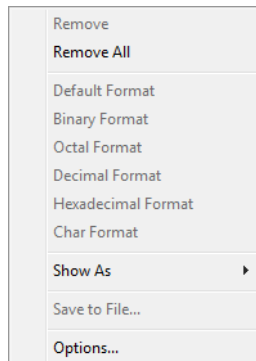

**Note:** The contents of this menu are dynamic and depend on which features that your combination of software and hardware supports. However, the list of menu commands below is complete and covers all possible commands.

These commands are available:

### Remove

Removes the selected expression from the window.

### Remove All

Removes all expressions listed in the window.



**Default Format,  
Binary Format,  
Octal Format,  
Decimal Format,  
Hexadecimal Format,  
Char Format**

Changes the display format of expressions. The display format setting affects different types of expressions in different ways. Your selection of display format is saved between debug sessions. These commands are available if a selected line in the window contains a variable.

The display format setting affects different types of expressions in these ways:

Variables	The display setting affects only the selected variable, not other variables.
Array elements	The display setting affects the complete array, that is, the same display format is used for each array element.
Structure fields	All elements with the same definition—the same field name and C declaration type—are affected by the display setting.

**Show As**

Displays a submenu that provides commands for changing the default type interpretation of variables. The commands on this submenu are mainly useful for assembler variables—data at assembler labels—because these are, by default, displayed as integers. For more information, see *Viewing assembler variables*, page 82.

**Options**

Displays the **IDE Options** dialog box where you can set various options, for example the **Update interval** option. The default value of this option is 1000 milliseconds, which means the **Live Watch** window will be updated once every second during program execution.

**Save to File**

Saves content to a file in a tab-separated format.

## Symbols window

The **Symbols** window is available from the **View** menu after you have enabled the Symbols plugin module.

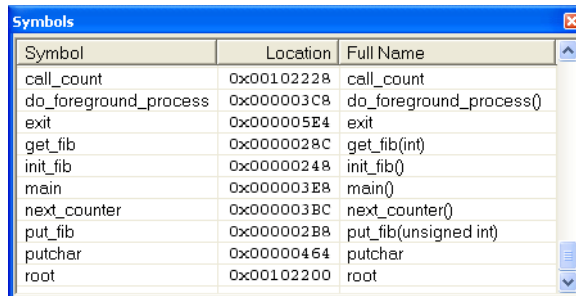

Symbol	Location	Full Name
call_count	0x00102228	call_count
do_foreground_process	0x000003C8	do_foreground_process()
exit	0x000005E4	exit
get_fib	0x0000028C	get_fib(int)
init_fib	0x00000248	init_fib()
main	0x000003E8	main()
next_counter	0x000003BC	next_counter()
put_fib	0x000002B8	put_fib(unsigned int)
putchar	0x00000464	putchar
root	0x00102200	root

This window displays all symbols with a static location, that is, C/C++ functions, assembler labels, and variables with static storage duration, including symbols from the runtime library.

To enable the Symbols plugin module, choose **Project>Options>Debugger>Select plugins to load>Symbols**.

### Requirements

None; this window is always available.

### Display area

This area contains these columns:

#### Symbol

The symbol name.

#### Location

The memory address.

#### Full name

The symbol name; often the same as the contents of the Symbol column but differs for example for C++ member functions.

Click the column headers to sort the list by symbol name, location, or full name.

## Context menu

This context menu is available:

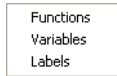

These commands are available:

### Functions

Toggles the display of function symbols on or off in the list.

### Variables

Toggles the display of variables on or off in the list.

### Labels

Toggles the display of labels on or off in the list.

## Resolve Symbol Ambiguity dialog box

The **Resolve Symbol Ambiguity** dialog box appears, for example, when you specify a symbol in the **Disassembly** window to go to, and there are several instances of the same symbol due to templates or function overloading.

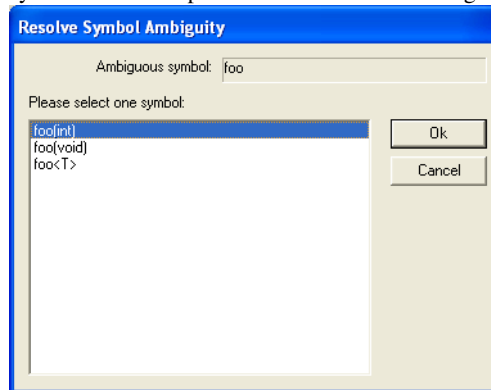

### Requirements

None; this window is always available.

### Ambiguous symbol

Indicates which symbol that is ambiguous.

**Please select one symbol**

A list of possible matches for the ambiguous symbol. Select the one you want to use.

# Breakpoints

- Introduction to setting and using breakpoints
- Setting breakpoints
- Reference information on breakpoints

---

## Introduction to setting and using breakpoints

These topics are covered:

- Reasons for using breakpoints
- Briefly about setting breakpoints
- Breakpoint types
- Breakpoint icons
- Breakpoints in the C-SPY simulator
- Breakpoints in the C-SPY hardware debugger drivers
- Breakpoint consumers

### REASONS FOR USING BREAKPOINTS

C-SPY® lets you set various types of breakpoints in the application you are debugging, allowing you to stop at locations of particular interest. You can set a breakpoint at a *code* location to investigate whether your program logic is correct, or to get trace printouts. In addition to code breakpoints, and depending on what C-SPY driver you are using, additional breakpoint types might be available. For example, you might be able to set a *data* breakpoint, to investigate how and when the data changes.

You can let the execution stop under certain *conditions*, which you specify. You can also let the breakpoint trigger a *side effect*, for instance executing a C-SPY macro function, by transparently stopping the execution and then resuming. The macro function can be defined to perform a wide variety of actions, for instance, simulating hardware behavior.

All these possibilities provide you with a flexible tool for investigating the status of your application.

### BRIEFLY ABOUT SETTING BREAKPOINTS

You can set breakpoints in many various ways, allowing for different levels of interaction, precision, timing, and automation. All the breakpoints you define will

appear in the Breakpoints window. From this window you can conveniently view all breakpoints, enable and disable breakpoints, and open a dialog box for defining new breakpoints. The **Breakpoint Usage** window also lists all internally used breakpoints, see *Breakpoint consumers*, page 105.

Breakpoints are set with a higher precision than single lines, using the same mechanism as when stepping; for more information about the precision, see *Single stepping*, page 56.

You can set breakpoints while you edit your code even if no debug session is active. The breakpoints will then be validated when the debug session starts. Breakpoints are preserved between debug sessions.

**Note:** For most hardware debugger systems it is only possible to set breakpoints when the application is not executing.

## BREAKPOINT TYPES

Depending on the C-SPY driver you are using, C-SPY supports different types of breakpoints.

### Code breakpoints

Code breakpoints are used for code locations to investigate whether your program logic is correct or to get trace printouts. Code breakpoints are triggered when an instruction is fetched from the specified location. If you have set the breakpoint on a specific machine instruction, the breakpoint will be triggered and the execution will stop, before the instruction is executed.

### Advanced breakpoints

Using the C-SPY ST-LINK driver, you can set *advanced breakpoints*. For this breakpoint type, you can choose to use data values, fetch conditions, and data accesses as breakpoint conditions.

### Log breakpoints

Log breakpoints provide a convenient way to add trace printouts without having to add any code to your application source code. Log breakpoints are triggered when an instruction is fetched from the specified location. If you have set the breakpoint on a specific machine instruction, the breakpoint will be triggered and the execution will temporarily stop and print the specified message in the C-SPY **Debug Log** window.

### Trace Start and Stop breakpoints

Trace Start and Stop breakpoints start and stop trace data collection—a convenient way to analyze instructions between two execution points.

## Data breakpoints

Data breakpoints are primarily useful for variables that have a fixed address in memory. If you set a breakpoint on an accessible local variable, the breakpoint is set on the corresponding memory location. The validity of this location is only guaranteed for small parts of the code. Data breakpoints are triggered when data is accessed at the specified location. The execution will usually stop directly after the instruction that accessed the data has been executed.

## Data Log breakpoints

Data log breakpoints are triggered when a specified memory address is accessed. A log entry is written in the **Data Log** window for each access. Data logs can also be displayed on the Data Log graph in the **Timeline** window, if that window is enabled.

You can set data log breakpoints using the **Breakpoints** window, the **Memory** window, and the editor window.

Using a single instruction, the microcontroller can only access values that are two bytes or less. If you specify a data log breakpoint on a memory location that cannot be accessed by one instruction, for example a `double` or a too large area in the **Memory** window, the result might not be what you intended.

## Immediate breakpoints

The C-SPY Simulator lets you set *immediate* breakpoints, which will halt instruction execution only temporarily. This allows a C-SPY macro function to be called when the simulated processor is about to read data from a location or immediately after it has written data. Instruction execution will resume after the action.

This type of breakpoint is useful for simulating memory-mapped devices of various kinds (for instance serial ports and timers). When the simulated processor reads from a memory-mapped location, a C-SPY macro function can intervene and supply appropriate data. Conversely, when the simulated processor writes to a memory-mapped location, a C-SPY macro function can act on the value that was written.

## BREAKPOINT ICONS

A breakpoint is marked with an icon in the left margin of the editor window, and the icon varies with the type of breakpoint:

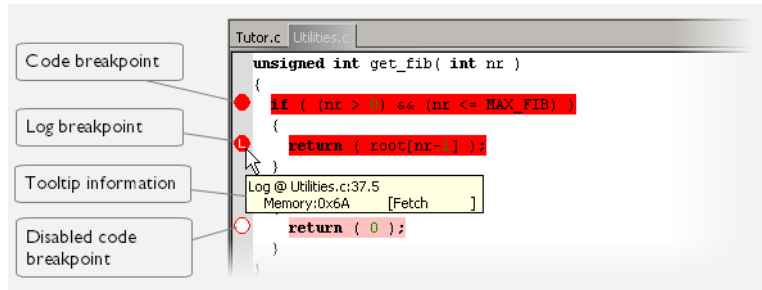

If the breakpoint icon does not appear, make sure the option **Show bookmarks** is selected, see Editor options in the *IDE Project Management and Building Guide for STM8*.



Just point at the breakpoint icon with the mouse pointer to get detailed tooltip information about all breakpoints set on the same location. The first row gives user breakpoint information, the following rows describe the physical breakpoints used for implementing the user breakpoint. The latter information can also be seen in the **Breakpoint Usage** window.

**Note:** The breakpoint icons might look different for the C-SPY driver you are using.

## BREAKPOINTS IN THE C-SPY SIMULATOR

The C-SPY simulator supports all breakpoint types and you can set an unlimited amount of breakpoints.

## BREAKPOINTS IN THE C-SPY HARDWARE DEBUGGER DRIVERS

Using the C-SPY drivers for hardware debugger systems you can set various breakpoint types. The amount of breakpoints you can set depends on the number of *hardware breakpoints* available on the target system.

The number of code breakpoints you can set in RAM and flash memory is unlimited. Depending on your debugger system, the number of code breakpoints you can set in ROM might be limited.



This table summarizes the characteristics of breakpoints for the different target systems:

<b>C-SPY hardware debugger driver</b>	<b>Code breakpoints</b>	<b>Data breakpoints</b>	<b>Advanced breakpoints</b>
ST-LINK, and STice using SWIM mode			
using N hardware breakpoints*	2*	1†	1†
using software breakpoints	Unlimited*	--	--
STice			
using N hardware breakpoints*	--	--	--
using software breakpoints	Unlimited	--	--

Table 6: Available breakpoints in C-SPY hardware debugger drivers

\* The number of available code breakpoints in ROM is limited to 2.

† The number of available data breakpoints and advanced breakpoints depends on the target system you are using.

If the driver and the device support software breakpoints, the debugger will first use any available hardware breakpoints before using software breakpoints. Exceeding the number of available hardware breakpoints causes the debugger to single step. This will significantly reduce the execution speed. For this reason you must be aware of the different breakpoint consumers.

## BREAKPOINT CONSUMERS

A debugger system includes several consumers of breakpoints.

### User breakpoints

The breakpoints you define in the breakpoint dialog box or by toggling breakpoints in the editor window often consume one physical breakpoint each, but this can vary greatly. Some user breakpoints consume several physical breakpoints and conversely, several user breakpoints can share one physical breakpoint. User breakpoints are displayed in the same way both in the Breakpoint Usage window and in the Breakpoints window, for example `Data @[R] callCount`.

### C-SPY itself

C-SPY itself also consumes breakpoints. C-SPY will set a breakpoint if:

- The debugger option **Run to** has been selected, and any step command is used. These are temporary breakpoints which are only set during a debug session. This means that they are not visible in the Breakpoints window.
- The linker option **Include C-SPY debugging support** has been selected.

In the DLIB runtime environment, C-SPY will set a system breakpoint on the `__DebugBreak` label.

These types of breakpoint consumers are displayed in the Breakpoint Usage window, for example, C-SPY Terminal I/O & libsupport module.

### C-SPY plugin modules

For example, modules for real-time operating systems can consume additional breakpoints. Specifically, by default, the Stack window consumes one physical breakpoint.

#### To disable the breakpoint used by the Stack window:

- 1 Choose **Tools>Options>Stack**.
- 2 Deselect the **Stack pointer(s) not valid until program reaches: *label*** option.

To disable the Stack window entirely, choose **Project>Options>Debugger>Plugins** and deselect the Stack plugin.

---

## Setting breakpoints

These tasks are covered:

- Various ways to set a breakpoint
- Toggling a simple code breakpoint
- Setting breakpoints using the dialog box
- Setting a data breakpoint in the Memory window
- Setting breakpoints using system macros
- Useful breakpoint hints.

### VARIOUS WAYS TO SET A BREAKPOINT

You can set a breakpoint in various ways:

- Toggling a simple code breakpoint.
- Using the **New Breakpoints** dialog box and the **Edit Breakpoints** dialog box available from the context menus in the editor window, **Breakpoints** window, and in the **Disassembly** window. The dialog boxes give you access to all breakpoint options.
- Setting a data breakpoint on a memory area directly in the **Memory** window.
- Using predefined system macros for setting breakpoints, which allows automation.

The different methods offer different levels of simplicity, complexity, and automation.

## TOGGLING A SIMPLE CODE BREAKPOINT

Toggling a code breakpoint is a quick method of setting a breakpoint. The following methods are available both in the editor window and in the **Disassembly** window:



- Click in the gray left-side margin of the window
- Place the insertion point in the C source statement or assembler instruction where you want the breakpoint, and click the **Toggle Breakpoint** button in the toolbar
- Choose **Edit>Toggle Breakpoint**
- Right-click and choose **Toggle Breakpoint** from the context menu.

## SETTING BREAKPOINTS USING THE DIALOG BOX

The advantage of using a breakpoint dialog box is that it provides you with a graphical interface where you can interactively fine-tune the characteristics of the breakpoints. You can set the options and quickly test whether the breakpoint works according to your intentions.

All breakpoints you define using a breakpoint dialog box are preserved between debug sessions.

You can open the dialog box from the context menu available in the editor window, Breakpoints window, and in the **Disassembly** window.

### To set a new breakpoint:

- 1** Choose **View>Breakpoints** to open the **Breakpoints** window.
- 2** In the **Breakpoints** window, right-click, and choose **New Breakpoint** from the context menu.
- 3** On the submenu, choose the breakpoint type you want to set.  
Depending on the C-SPY driver you are using, different breakpoint types are available.
- 4** In the breakpoint dialog box that appears, specify the breakpoint settings and click **OK**.  
The breakpoint is displayed in the **Breakpoints** window.

### To modify an existing breakpoint:

- 1 In the **Breakpoints** window, editor window, or in the **Disassembly** window, select the breakpoint you want to modify and right-click to open the context menu.

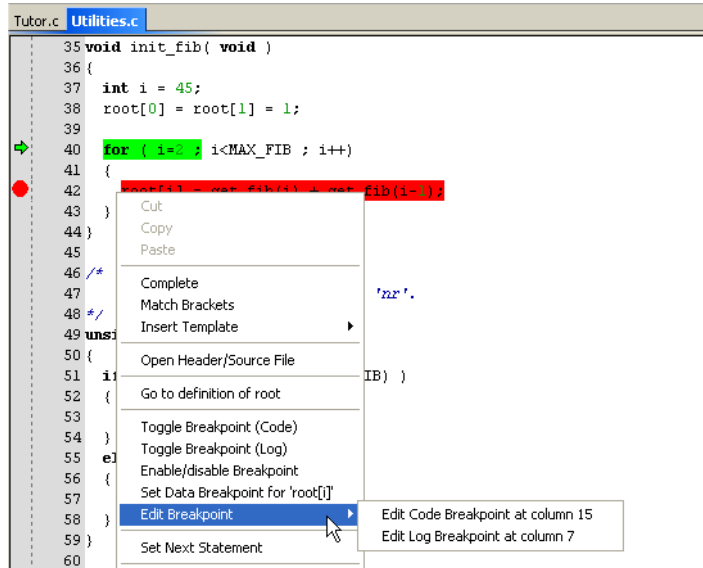

If there are several breakpoints on the same source code line, the breakpoints will be listed on a submenu.

- 2 On the context menu, choose the appropriate command.
- 3 In the breakpoint dialog box that appears, specify the breakpoint settings and click **OK**.

The breakpoint is displayed in the **Breakpoints** window.

### SETTING A DATA BREAKPOINT IN THE MEMORY WINDOW

You can set breakpoints directly on a memory location in the **Memory** window.

Right-click in the window and choose the breakpoint command from the context menu that appears. To set the breakpoint on a range, select a portion of the memory contents.

The breakpoint is not highlighted in the **Memory** window; instead, you can see, edit, and remove it using the **Breakpoints** window, which is available from the **View** menu. The breakpoints you set in the **Memory** window will be triggered for both read and write accesses. All breakpoints defined in this window are preserved between debug sessions.

**Note:** Setting breakpoints directly in the **Memory** window is only possible if the driver you use supports this.

## SETTING BREAKPOINTS USING SYSTEM MACROS

You can set breakpoints not only in the breakpoint dialog box but also by using built-in C-SPY system macros. When you use system macros for setting breakpoints, the breakpoint characteristics are specified as macro parameters.

Macros are useful when you have already specified your breakpoints so that they fully meet your requirements. You can define your breakpoints in a macro file, using built-in system macros, and execute the file at C-SPY startup. The breakpoints will then be set automatically each time you start C-SPY. Another advantage is that the debug session will be documented, and that several engineers involved in the development project can share the macro files.

**Note:** If you use system macros for setting breakpoints, you can still view and modify them in the Breakpoints window. In contrast to using the dialog box for defining breakpoints, all breakpoints that are defined using system macros are removed when you exit the debug session.

These breakpoint macros are available:

C-SPY macro for breakpoints	Simulator	ST-LINK	STice
__setCodeBreak	Yes	Yes	Yes
__setDataBreak	Yes	Yes	—
__setLogBreak	Yes	—	—
__setDataLogBreak	Yes	—	—
__setSimBreak	Yes	—	—
__setTraceStartBreak	Yes	—	—
__setTraceStopBreak	Yes	—	—
__clearBreak	Yes	Yes	Yes

Table 7: C-SPY macros for breakpoints

For information about each breakpoint macro, see *Reference information on C-SPY system macros*, page 267.

## Setting breakpoints at C-SPY startup using a setup macro file

You can use a setup macro file to define breakpoints at C-SPY startup. Follow the procedure described in *Using C-SPY macros*, page 255.

## USEFUL BREAKPOINT HINTS

Below are some useful hints related to setting breakpoints.



### Tracing incorrect function arguments

If a function with a pointer argument is sometimes incorrectly called with a `NULL` argument, you might want to debug that behavior. These methods can be useful:

- Set a breakpoint on the first line of the function with a condition that is true only when the parameter is 0. The breakpoint will then not be triggered until the problematic situation actually occurs. The advantage of this method is that no extra source code is needed. The drawback is that the execution speed might become unacceptably low.
- You can use the `assert` macro in your problematic function, for example:

```
int MyFunction(int * MyPtr)
{
    assert(MyPtr != 0); /* Assert macro added to your source
                        code. */
    /* Here comes the rest of your function. */
}
```

The execution will break whenever the condition is true. The advantage is that the execution speed is only very slightly affected, but the drawback is that you will get a small extra footprint in your source code. In addition, the only way to get rid of the execution stop is to remove the macro and rebuild your source code.

- Instead of using the `assert` macro, you can modify your function like this:

```
int MyFunction(int * MyPtr)
{
    if(MyPtr == 0)
        MyDummyStatement; /* Dummy statement where you set a
                            breakpoint. */
    /* Here comes the rest of your function. */
}
```

You must also set a breakpoint on the extra dummy statement, so that the execution will break whenever the condition is true. The advantage is that the execution speed is only very slightly affected, but the drawback is that you will still get a small extra footprint in your source code. However, in this way you can get rid of the execution stop by just removing the breakpoint.



### Performing a task and continuing execution

You can perform a task when a breakpoint is triggered and then automatically continue execution.

You can use the **Action** text box to associate an action with the breakpoint, for instance a C-SPY macro function. When the breakpoint is triggered and the execution of your application has stopped, the macro function will be executed. In this case, the execution will not continue automatically.

Instead, you can set a condition which returns 0 (false). When the breakpoint is triggered, the condition—which can be a call to a C-SPY macro that performs a task—is evaluated and because it is not true, execution continues.

Consider this example where the C-SPY macro function performs a simple task:

```
__var my_counter;  
  
count ()  
{  
    my_counter += 1;  
    return 0;  
}
```

To use this function as a condition for the breakpoint, type `count ()` in the **Expression** text box under **Conditions**. The task will then be performed when the breakpoint is triggered. Because the macro function `count` returns 0, the condition is false and the execution of the program will resume automatically, without any stop.

---

## Reference information on breakpoints

Reference information about:

- *Breakpoints window*, page 112
- *Breakpoint Usage window*, page 113
- *Advanced breakpoints dialog box*, page 114
- *Code breakpoints dialog box*, page 117
- *Log breakpoints dialog box*, page 119
- *Data breakpoints dialog box*, page 120
- *Data Log breakpoints dialog box*, page 122
- *Immediate breakpoints dialog box*, page 123
- *Enter Location dialog box*, page 124
- *Resolve Source Ambiguity dialog box*, page 126.

See also:

- *Reference information on C-SPY system macros*, page 267
- *Reference information on trace*, page 168.

## Breakpoints window

The **Breakpoints** window is available from the **View** menu.

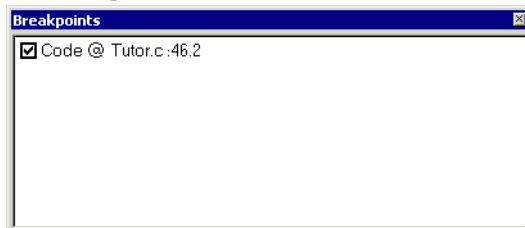

This window lists all breakpoints you define.

Use this window to conveniently monitor, enable, and disable breakpoints; you can also define new breakpoints and modify existing breakpoints.

### Requirements

None; this window is always available.

### Display area

This area lists all breakpoints you define. For each breakpoint, information about the breakpoint type, source file, source line, and source column is provided.

### Context menu

This context menu is available:

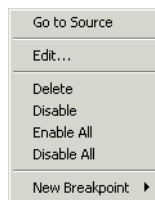

These commands are available:

#### Go to Source

Moves the insertion point to the location of the breakpoint, if the breakpoint has a source location. Double-click a breakpoint in the **Breakpoints** window to perform the same command.

#### Edit

Opens the breakpoint dialog box for the breakpoint you selected.



**Delete**

Deletes the breakpoint. Press the Delete key to perform the same command.

**Enable**

Enables the breakpoint. The check box at the beginning of the line will be selected. You can also perform the command by manually selecting the check box. This command is only available if the breakpoint is disabled.

**Disable**

Disables the breakpoint. The check box at the beginning of the line will be deselected. You can also perform this command by manually deselecting the check box. This command is only available if the breakpoint is enabled.

**Enable All**

Enables all defined breakpoints.

**Disable All**

Disables all defined breakpoints.

**New Breakpoint**

Displays a submenu where you can open the breakpoint dialog box for the available breakpoint types. All breakpoints you define using this dialog box are preserved between debug sessions.

**Breakpoint Usage window**

The **Breakpoint Usage** window is available from the menu specific to the C-SPY driver you are using.



This window lists all breakpoints currently set in the target system, both the ones you have defined and the ones used internally by C-SPY. The format of the items in this window depends on the C-SPY driver you are using.

The window gives a low-level view of all breakpoints, related but not identical to the list of breakpoints displayed in the **Breakpoints** window.

C-SPY uses breakpoints when stepping. see the **Breakpoint Usage** window for:

- Identifying all breakpoint consumers
- Checking that the number of active breakpoints is supported by the target system
- Configuring the debugger to use the available breakpoints in a better way, if possible.

For more information, see .

### Requirements

None; this window is always available.

### Display area

For each breakpoint in the list, the address and access type are displayed. Each breakpoint in the list can also be expanded to show its originator.

## Advanced breakpoints dialog box

The **Advanced Breakpoint** dialog box is available from the context menu in the Breakpoints window.

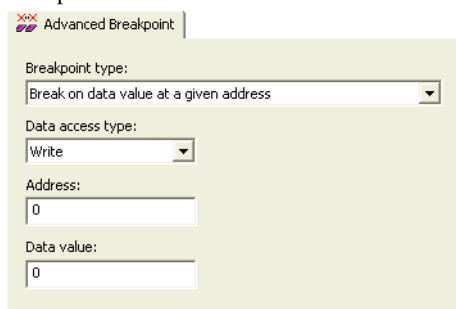

Use this dialog box to set an advanced breakpoint for which you can choose to use data values, fetch conditions, and data accesses as breakpoint conditions.

Depending on which breakpoint type you have chosen, different settings are available. Descriptions of the breakpoint types and their settings follow.

### Requirements

- The C-SPY ST-LINK driver
- The C-SPY STice driver, using SWIM mode.

**Break on data value at a given address**

This breakpoint type breaks on the occurrence of a specific value at a specified data address.

**Access mode**

Choose between: Write, Read, and Read/Write.

**Address**

Specify the address where the value is stored.

**Data value**

Specify the data value at the specified address.

**Break on operation code fetch within or outside an address range**

These breakpoint types break on the occurrence of any operation code fetch within or outside of a specified address range, respectively.

**First address**

Specify the first address of the range.

**Last address**

Specify the last address of the range.

**Break on data access within or outside an address range**

These breakpoint types break on the occurrence of a data access within or outside a specified address range.

**Access mode**

Choose between: Write, Read, and Read/Write.

**First address**

Specify the first address of the range.

**Last address**

Specify the last address of the range.

**Break on two sequential operation code fetches**

This breakpoint type breaks when two operation code fetches have occurred in sequence; the occurrence of the first operation code fetch must precede the occurrence of the second operation code fetch.

**First address**

Specify the address where the first operation code fetch must occur.

**Second address**

Specify the address where the second operation code fetch must occur.

**Break on data access at one of two addresses**

This breakpoint breaks on the occurrence of a data access at either of two addresses.

**Access mode**

Choose between: Write, Read, and Read/Write.

**First address**

Specify the first of the two addresses.

**Second address**

Specify the second of the two addresses.

**Break on operation code fetch or data access at given addresses**

This breakpoint type breaks either on the occurrence of an operation code fetch at a specified address, or the occurrence of a data access at a specified address.

**Access mode**

Choose between: Write, Read, and Read/Write.

**Fetch address**

Specify the address where the operation code fetch must occur.

**Data address**

Specify the address where the data access must occur.

**Break on stack write or operation code fetch at a given address**

This breakpoint type breaks on the occurrence of either a write operation to the stack below a specified address, or an operation code fetch at a specified address.

**Max stack address**

Specify the maximum stack address below which the write operation must occur.

**Fetch address**

Specify the address where the operation code fetch must occur.

**Break on stack write or data access at a given address**

This breakpoint type breaks on the occurrence of either a write operation to the stack below a specified address, or a data access at a specified address.

**Access mode**

Choose between: Write, Read, and Read/Write.

**Data address**

Specify the address where the data access must occur.

**Max stack address**

Specify the maximum stack address below which the write operation must occur.

**Code breakpoints dialog box**

The **Code** breakpoints dialog box is available from the context menu in the editor window, **Breakpoints** window, and in the **Disassembly** window.

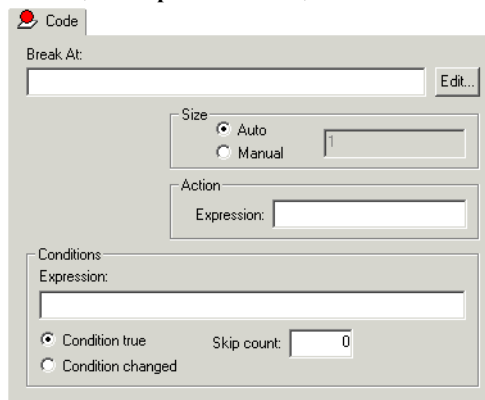

This figure reflects the C-SPY simulator.

Use the **Code** breakpoints dialog box to set a code breakpoint, see *Setting breakpoints using the dialog box*, page 107.

**Requirements**

One of these alternatives:

- The C-SPY simulator
- The C-SPY ST-LINK driver
- The C-SPY STice driver.

**Break At**

Specify the code location of the breakpoint in the text box. Alternatively, click the **Edit** button to open the **Enter Location** dialog box, see *Enter Location dialog box*, page 124.

## **Size**

Determines whether there should be a size—in practice, a range—of locations where the breakpoint will trigger. Each fetch access to the specified memory range will trigger the breakpoint. Select how to specify the size:

### **Auto**

The size will be set automatically, typically to 1.

### **Manual**

Specify the size of the breakpoint range in the text box.

## **Action**

Specify a valid C-SPY expression, which is evaluated when the breakpoint is triggered and the condition is true. For more information, see *Useful breakpoint hints*, page 110.

## **Conditions**

Specify simple or complex conditions:

### **Expression**

Specify a valid C-SPY expression, see *C-SPY expressions*, page 78.

### **Condition true**

The breakpoint is triggered if the value of the expression is true.

### **Condition changed**

The breakpoint is triggered if the value of the expression has changed since it was last evaluated.

### **Skip count**

The number of times that the breakpoint condition must be fulfilled before the breakpoint starts triggering. After that, the breakpoint will trigger every time the condition is fulfilled.

## Log breakpoints dialog box

The **Log** breakpoints dialog box is available from the context menu in the editor window, **Breakpoints** window, and in the **Disassembly** window.

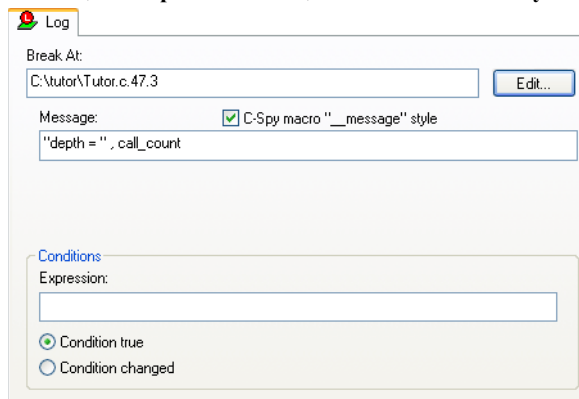

This figure reflects the C-SPY simulator.

Use the **Log** breakpoints dialog box to set a log breakpoint, see *Setting breakpoints using the dialog box*, page 107.

### Requirements

The C-SPY simulator.

### Trigger at

Specify the code location of the breakpoint. Alternatively, click the **Edit** button to open the **Enter Location** dialog box, see *Enter Location dialog box*, page 124.

### Message

Specify the message you want to be displayed in the C-SPY **Debug Log** window. The message can either be plain text, or—if you also select the option **C-SPY macro \"\_\_message\" style**—a comma-separated list of arguments.

### C-SPY macro \"\_\_message\" style

Select this option to make a comma-separated list of arguments specified in the **Message** text box be treated exactly as the arguments to the C-SPY macro language statement `__message`, see *Formatted output*, page 263.

## Conditions

Specify simple or complex conditions:

### Expression

Specify a valid C-SPY expression, see *C-SPY expressions*, page 78.

### Condition true

The breakpoint is triggered if the value of the expression is true.

### Condition changed

The breakpoint is triggered if the value of the expression has changed since it was last evaluated.

## Data breakpoints dialog box

The **Data** breakpoints dialog box is available from the context menu in the editor window, **Breakpoints** window, the **Memory** window, and in the **Disassembly** window.

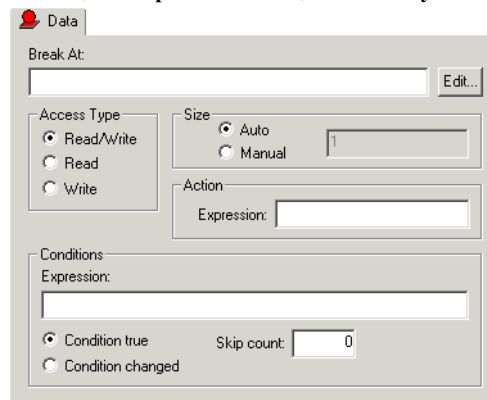

This figure reflects the C-SPY simulator.

Use the **Data** breakpoints dialog box to set a data breakpoint, see *Setting breakpoints using the dialog box*, page 107. Data breakpoints never stop execution within a single instruction. They are recorded and reported after the instruction is executed.

## Requirements

One of these alternatives:

- The C-SPY simulator
- The C-SPY ST-LINK driver.



**Break At**

Specify the data location of the breakpoint in the text box. Alternatively, click the **Edit** button to open the **Enter Location** dialog box, see *Enter Location dialog box*, page 124.

**Access Type**

Selects the type of memory access that triggers the breakpoint:

**Read/Write**

Reads from or writes to location.

**Read**

Reads from location.

**Write**

Writes to location.

**Size**

Determines whether there should be a size—in practice, a range—of locations where the breakpoint will trigger. Each fetch access to the specified memory range will trigger the breakpoint. Select how to specify the size:

**Auto**

The size will automatically be based on the type of expression the breakpoint is set on. For example, if you set the breakpoint on a 12-byte structure, the size of the breakpoint will be 12 bytes.

**Manual**

Specify the size of the breakpoint range in the text box.

For data breakpoints, this can be useful if you want the breakpoint to be triggered on accesses to data structures, such as arrays, structs, and unions.

**Action**

Specify a valid C-SPY expression, which is evaluated when the breakpoint is triggered and the condition is true. For more information, see *Useful breakpoint hints*, page 110.

**Conditions**

Specify simple or complex conditions:

**Expression**

Specify a valid C-SPY expression, see *C-SPY expressions*, page 78.

**Condition true**

The breakpoint is triggered if the value of the expression is true.

**Condition changed**

The breakpoint is triggered if the value of the expression has changed since it was last evaluated.

**Skip count**

The number of times that the breakpoint condition must be fulfilled before the breakpoint starts triggering. After that, the breakpoint will trigger every time the condition is fulfilled.

**Data Log breakpoints dialog box**

The **Data Log** breakpoints dialog box is available from the context menu in the **Breakpoints** window.

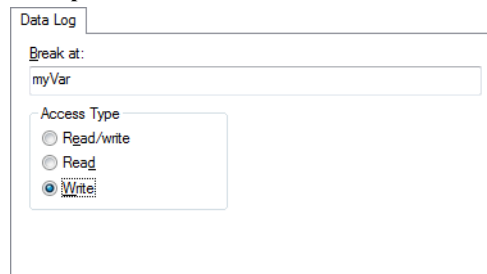

This figure reflects the C-SPY simulator.

Use the **Data Log** breakpoints dialog box to set a maximum of four data log breakpoints on memory addresses, see *Setting breakpoints using the dialog box*, page 107.

See also *Data Log breakpoints*, page 103 and *Getting started using data logging*, page 187.

**Requirements**

The C-SPY simulator.

**Trigger at**

Specify the data location of the breakpoint. Alternatively, click the **Edit** button to open the **Enter Location** dialog box, see *Enter Location dialog box*, page 124.

**Access Type**

Selects the type of memory access that triggers the breakpoint:

**Read/Write**

Reads from or writes to location.

**Read**

Reads from location.

**Write**

Writes to location.

## Immediate breakpoints dialog box

The **Immediate** breakpoints dialog box is available from the context menu in the editor window, **Breakpoints** window, the **Memory** window, and in the **Disassembly** window.

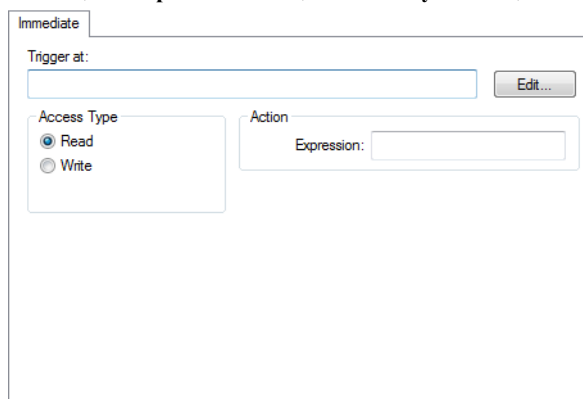

In the C-SPY simulator, use the **Immediate** breakpoints dialog box to set an immediate breakpoint, see *Setting breakpoints using the dialog box*, page 107. Immediate breakpoints do not stop execution at all; they only suspend it temporarily.

### Requirements

The C-SPY simulator.

### Trigger at

Specify the data location of the breakpoint. Alternatively, click the **Edit** button to open the **Enter Location** dialog box, see *Enter Location dialog box*, page 124.

### Access Type

Selects the type of memory access that triggers the breakpoint:

**Read**

Reads from location.

**Write**

Writes to location.

**Action**

Specify a valid C-SPY expression, which is evaluated when the breakpoint is triggered and the condition is true. For more information, see *Useful breakpoint hints*, page 110.

**Enter Location dialog box**

The **Enter Location** dialog box is available from the breakpoints dialog box, either when you set a new breakpoint or when you edit a breakpoint.

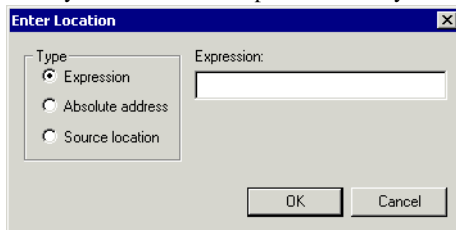

Use the **Enter Location** dialog box to specify the location of the breakpoint.

**Note:** This dialog box looks different depending on the **Type** you select.

**Type**

Selects the type of location to be used for the breakpoint, choose between:

**Expression**

A C-SPY expression, whose value evaluates to a valid code or data location.

A code location, for example the function `main`, is typically used for code breakpoints.

A data location is the name of a variable and is typically used for data breakpoints. For example, `my_var` refers to the location of the variable `my_var`, and `arr[3]` refers to the location of the fourth element of the array `arr`. For static variables declared with the same name in several functions, use the syntax `my_func:my_static_variable` to refer to a specific variable.

For more information about C-SPY expressions, see *C-SPY expressions*, page 78.

### Absolute address

An absolute location on the form *zone:hexaddress* or simply *hexaddress* (for example `Memory:0x42`). *zone* refers to C-SPY memory zones and specifies in which memory the address belongs, see *C-SPY memory zones*, page 128.

### Source location

A location in your C source code using the syntax:

```
{filename}.row.column.
```

*filename* specifies the filename and full path.

*row* specifies the row in which you want the breakpoint.

*column* specifies the column in which you want the breakpoint.

For example, `{C:\src\prog.c}.22.3`

sets a breakpoint on the third character position on row 22 in the source file `prog.c`. Note that in quoted form, for example in a C-SPY macro, you must instead write `{C:\src\prog.c}.22.3`.

Note that the Source location type is usually meaningful only for code locations in code breakpoints. Depending on the C-SPY driver you are using, **Source location** might not be available for data and immediate breakpoints.

## Resolve Source Ambiguity dialog box

The **Resolve Source Ambiguity** dialog box appears, for example, when you try to set a breakpoint on templates and the source location corresponds to more than one function.

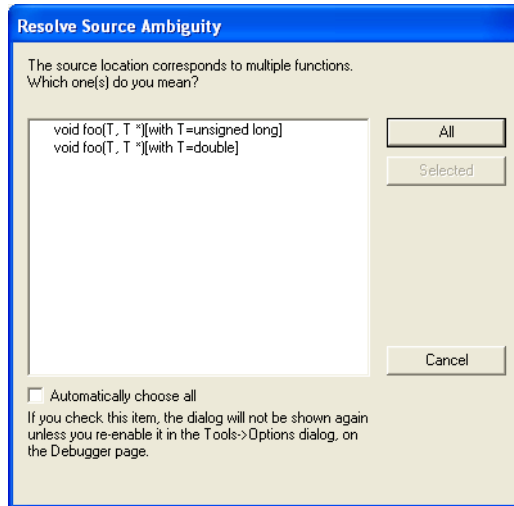

To resolve a source ambiguity, perform one of these actions:

- In the text box, select one or several of the listed locations and click **Selected**.
- Click **All**.

### All

The breakpoint will be set on all listed locations.

### Selected

The breakpoint will be set on the source locations that you have selected in the text box.

### Cancel

No location will be used.

### Automatically choose all

Determines that whenever a specified source location corresponds to more than one function, all locations will be used.

Note that this option can also be specified in the **IDE Options** dialog box, see Debugger options in the *IDE Project Management and Building Guide for STM8*.

# Memory and registers

- Introduction to monitoring memory and registers
- Monitoring memory and registers
- Reference information on memory and registers

---

## Introduction to monitoring memory and registers

These topics are covered:

- Briefly about monitoring memory and registers
- C-SPY memory zones
- Memory configuration for the C-SPY simulator

### BRIEFLY ABOUT MONITORING MEMORY AND REGISTERS

C-SPY provides many windows for monitoring memory and registers, each of them available from the **View** menu:

- The **Memory** window  
Gives an up-to-date display of a specified area of memory—a memory zone—and allows you to edit it. *Data coverage* along with execution of your application is highlighted with different colors. You can fill specified areas with specific values and you can set breakpoints directly on a memory location or range. You can open several instances of this window, to monitor different memory areas. The content of the window can be regularly updated while your application is executing.
- The **Symbolic Memory** window  
Displays how variables with static storage duration are laid out in memory. This can be useful for better understanding memory usage or for investigating problems caused by variables being overwritten, for example by buffer overruns.
- The **Stack** window  
Displays the contents of the stack, including how stack variables are laid out in memory. In addition, integrity checks of the stack can be performed to detect and warn about problems with stack overflow. For example, the **Stack** window is useful for determining the optimal size of the stack. You can open up to two instances of this window, each showing different stacks or different display modes of the same stack.

- The **Registers** window

Gives an up-to-date display of the contents of the processor registers and SFRs, and allows you to edit them. Because of the large amount of registers—memory-mapped peripheral unit registers and CPU registers—it is inconvenient to show all registers concurrently in the **Registers** window. Instead you can divide registers into *application-specific groups*. You can choose to load either predefined register groups or define your own groups. You can open several instances of this window, each showing a different register group.

- The **SFR Setup** window

Displays the currently defined SFRs that C-SPY has information about, both factory-defined (retrieved from the device description file) and custom-defined SFRs. If required, you can use the **Edit SFR** dialog box to customize the SFR definitions.

To view the memory contents for a specific variable, simply drag the variable to the **Memory** window or the **Symbolic** memory window. The memory area where the variable is located will appear.



Reading the value of some registers might influence the runtime behavior of your application. For example, reading the value of a UART status register might reset a pending bit, which leads to the lack of an interrupt that would have processed a received byte. To prevent this from happening, make sure that the **Registers** window containing any such registers is closed when debugging a running application.

## C-SPY MEMORY ZONES

In C-SPY, the term *zone* is used for a named memory area. A memory address, or *location*, is a combination of a zone and a numerical offset into that zone. By default,



the STM8 architecture has one zone, `Memory`, which covers the whole STM8 memory range.

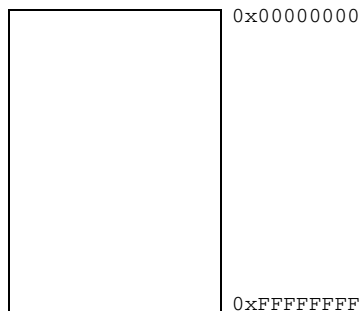

Default zone `Memory`

Memory zones are used in several contexts, most importantly in the **Memory** and **Disassembly** windows, and in C-SPY macros. In the windows, use the **Zone** box to choose which memory zone to display.

## MEMORY CONFIGURATION FOR THE C-SPY SIMULATOR

To simulate the target system properly, the C-SPY simulator needs information about the memory configuration. By default, C-SPY uses a configuration based on information retrieved from the device description file.

The C-SPY simulator provides various mechanisms to improve the configuration further:

- If the default memory configuration does not specify the required memory address ranges, you can specify the memory address ranges shall be based on:
  - The zones predefined in the device description file
  - The section information available in the debug file
  - Or, you can define your own memory address ranges, which you typically might want to do if the files do not specify memory ranges for the *specific* device that you are using, but instead for a *family* of devices (perhaps with various amounts of on-chip RAM).
- For each memory address range, you can specify an *access type*. If a memory access occurs that does not agree with the specified access type, C-SPY will regard this as an illegal access and warn about it. In addition, an access to memory that is not defined is regarded as an illegal access. The purpose of memory access checking is to help you to identify memory access violations.

For more information, see *Memory Configuration dialog box, for the C-SPY simulator*, page 158.

## Monitoring memory and registers

These tasks are covered:

- *Defining application-specific register groups*, page 130
- *Monitoring stack usage*, page 131

### DEFINING APPLICATION-SPECIFIC REGISTER GROUPS

Defining application-specific register groups minimizes the amount of registers displayed in the **Registers** windows and makes the debugging easier.

- 1 Choose **View>Registers>Register User Groups Setup** during a debug session.

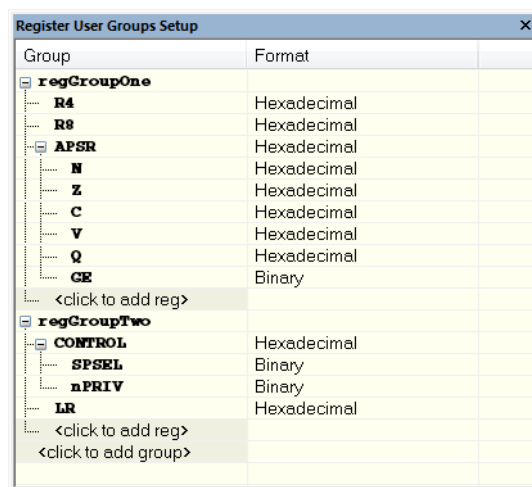

Right-clicking in the window displays a context menu with commands. For information about these commands, see *Register User Groups Setup window*, page 151.

- 2 Click on <click to add group> and specify the name of your group, for example **My Timer Group** and press Enter.
- 3 Underneath the group name, click on <click to add reg> and type the name of a register, and press Enter. You can also drag a register name from another window in the IDE. Repeat this for all registers that you want to add to your group.

- 4 As an optional step, right-click any registers for which you want to change the integer base, and choose **Format** from the context menu to select a suitable base.
- 5 When you are done, your new group is now available in the **Registers** windows.

If you want to define more application-specific groups, repeat this procedure for each group you want to define.

**Note:** If a certain SFR that you need cannot be added to a group, you can register your own SFRs. For more information, see *SFR Setup window*, page 153.

## MONITORING STACK USAGE

These are the two main use cases for the **Stack** window:

- Monitoring stack memory usage
- Monitoring the stack memory content.

In both cases, C-SPY retrieves information about the defined stack size and its allocation from the definition in the linker configuration file of the section holding the stack. If you, for some reason, have modified the stack initialization in the system startup code, `cstartup`, you should also change the section definition in the linker configuration file accordingly; otherwise the **Stack** window cannot track the stack usage. For more information about this, see the *IAR C/C++ Development Guide for STM8*.

### To monitor stack memory usage:

- 1 Before you start C-SPY, choose **Tools>Options**. On the **Stack** page:
  - Select **Enable graphical stack display and stack usage tracking**. This option also enables the option **Warn when exceeding stack threshold**. Specify a suitable threshold value.
  - Notice also the option **Warn when stack pointer is out of bounds**. Any such warnings are displayed in the **Debug Log** window.

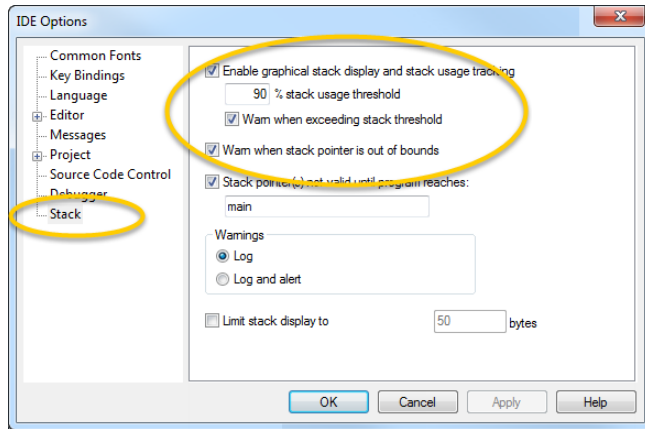

**2** Start C-SPY.

When your application is first loaded, and upon each reset, the memory for the stack area is filled with the dedicated byte value `0xCD` before the application starts executing.

**3** Choose **View>Stack>Stack 1** to open the **Stack** window.

Notice that you can open up to two **Stack** windows, each showing a different stack—if several stacks are available—or the same stack with different display settings.

**4** Start executing your application.

Whenever execution stops, the stack memory is searched from the end of the stack until a byte whose value is not `0xCD` is found, which is assumed to be how far the stack has been used. The light gray area of the stack bar represents the *unused* stack memory area, whereas the dark gray area of the bar represents the *used* stack memory.

For this example, you can see that only 44% of the reserved memory address range was used, which means that it could be worth considering decreasing the size of memory:

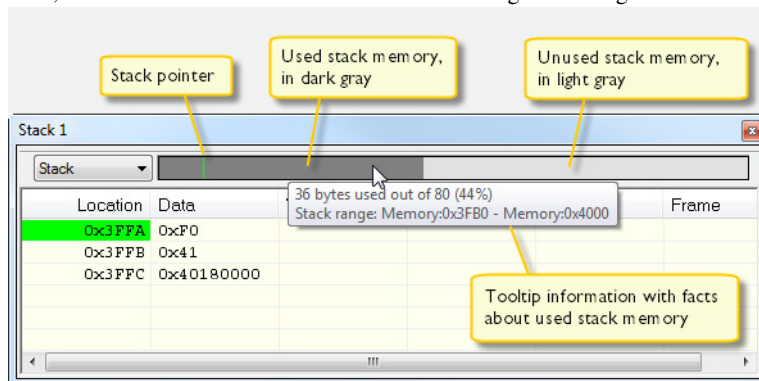

**Note:** Although this is a reasonably reliable way to track stack usage, there is no guarantee that a stack overflow is detected. For example, a stack *can* incorrectly grow outside its bounds, and even modify memory outside the stack area, without actually modifying any of the bytes near the end of the stack range. Likewise, your application might modify memory within the stack area by mistake.

#### To monitor the stack memory content:

- 1 Before you start monitoring stack memory, you might want to disable the option **Enable graphical stack display and stack usage tracking** to improve performance during debugging.
- 2 Start C-SPY.
- 3 Choose **View>Stack>Stack 1** to open the **Stack** window.  
Notice that you can access various context menus in the display area from where you can change display format, etc.
- 4 Start executing your application.

Whenever execution stops, you can monitor the stack memory, for example to see function parameters that are passed on the stack:

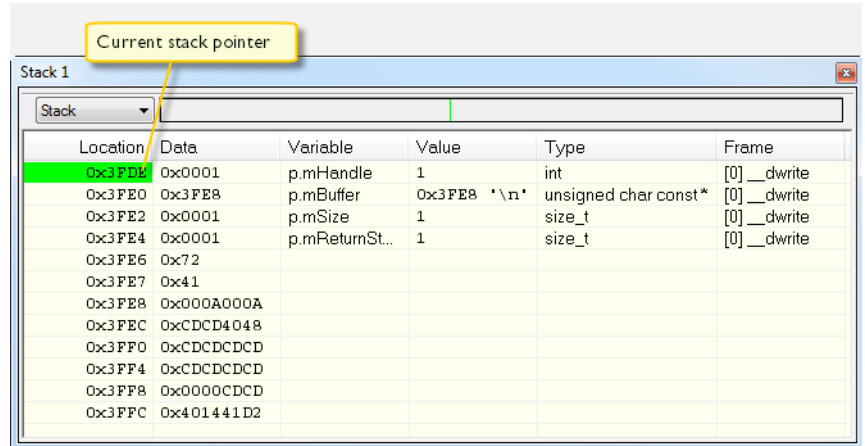

## Reference information on memory and registers

Reference information about:

- *Memory window*, page 135
- *Memory Save dialog box*, page 139
- *Memory Restore dialog box*, page 140
- *Fill dialog box*, page 141
- *Symbolic Memory window*, page 142
- *Stack window*, page 145
- *Registers window*, page 148
- *Register User Groups Setup window*, page 151
- *SFR Setup window*, page 153
- *Edit SFR dialog box*, page 156
- *Memory Configuration dialog box, for the C-SPY simulator*, page 158
- *Edit Memory Range dialog box, for the C-SPY simulator*, page 160

## Memory window

The **Memory** window is available from the **View** menu.

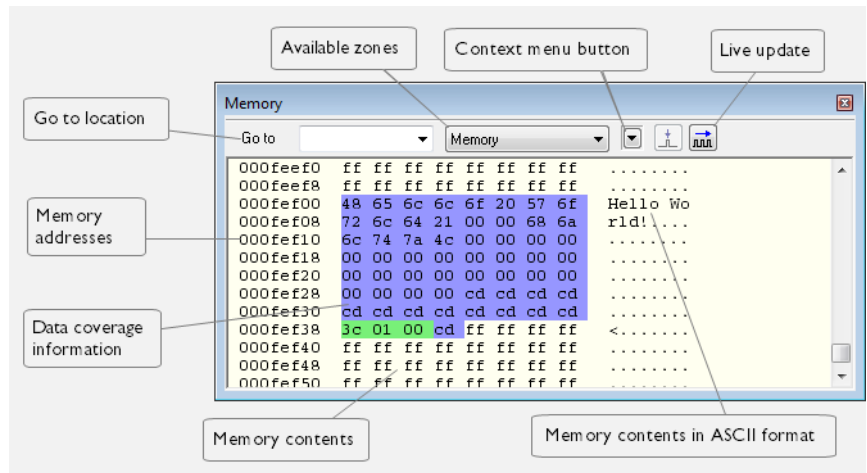

This window gives an up-to-date display of a specified area of memory—a memory zone—and allows you to edit it. You can open several instances of this window, which is very convenient if you want to keep track of several memory or register zones, or monitor different parts of the memory.



To view the memory corresponding to a variable, you can select it in the editor window and drag it to the **Memory** window.

See also *Editing in C-SPY windows*, page 42.

### Requirements

None; this window is always available.

### Toolbar

The toolbar contains:

#### Go to

The memory location or symbol you want to view.

#### Zone

Selects a memory zone, see *C-SPY memory zones*, page 128.

#### Context menu button

Displays the context menu.

### Update Now

Updates the content of the **Memory** window while your application is executing. This button is only enabled if the C-SPY driver you are using has access to the target system memory while your application is executing.

### Live Update

Updates the contents of the **Memory** window regularly while your application is executing. This button is only enabled if the C-SPY driver you are using has access to the target system memory while your application is executing. To set the update frequency, specify an appropriate frequency in the **IDE Options>Debugger** dialog box.

### Display area

The display area shows the addresses currently being viewed, the memory contents in the format you have chosen, and—provided that the display mode is set to **1x Units**—the memory contents in ASCII format. You can edit the contents of the display area, both in the hexadecimal part and the ASCII part of the area.

Data coverage is displayed with these colors:

Yellow	Indicates data that has been read.
Blue	Indicates data that has been written
Green	Indicates data that has been both read and written.

**Note:** Data coverage is not supported by all C-SPY drivers. Data coverage is supported by the C-SPY Simulator.



## Context menu

This context menu is available:

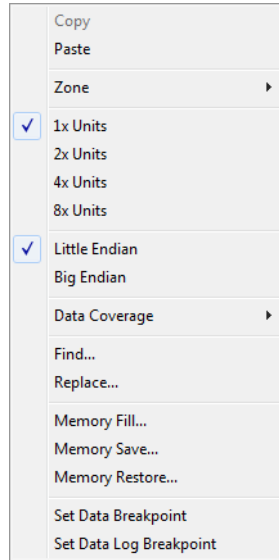

These commands are available:

### Copy, Paste

Standard editing commands.

### Zone

Selects a memory zone, see *C-SPY memory zones*, page 128.

### 1x Units

Displays the memory contents as single bytes.

### 2x Units

Displays the memory contents as 2-byte groups.

### 4x Units

Displays the memory contents as 4-byte groups.

### 8x Units

Displays the memory contents as 8-byte groups.

### Little Endian

Displays the contents in little-endian byte order.

### **Big Endian**

Displays the contents in big-endian byte order.

### **Data Coverage**

Choose between:

**Enable** toggles data coverage on or off.

**Show** toggles between showing or hiding data coverage.

**Clear** clears all data coverage information.

These commands are only available if your C-SPY driver supports data coverage.

### **Find**

Displays a dialog box where you can search for text within the **Memory** window; read about the **Find** dialog box in the *IDE Project Management and Building Guide for STM8*.

### **Replace**

Displays a dialog box where you can search for a specified string and replace each occurrence with another string; read about the **Replace** dialog box in the *IDE Project Management and Building Guide for STM8*.

### **Memory Fill**

Displays a dialog box, where you can fill a specified area with a value, see *Fill dialog box*, page 141.

### **Memory Save**

Displays a dialog box, where you can save the contents of a specified memory area to a file, see *Memory Save dialog box*, page 139.

### **Memory Restore**

Displays a dialog box, where you can load the contents of a file in Intel-hex or Motorola s-record format to a specified memory zone, see *Memory Restore dialog box*, page 140.

### **Set Data Breakpoint**

Sets breakpoints directly in the **Memory** window. The breakpoint is not highlighted; you can see, edit, and remove it in the **Breakpoints** dialog box. The breakpoints you set in this window will be triggered for both read and write access. For more information, see *Setting a data breakpoint in the Memory window*, page 108.

### Set Data Log Breakpoint

Sets a breakpoint on the start address of a memory selection directly in the **Memory** window. The breakpoint is not highlighted; you can see, edit, and remove it in the **Breakpoints** dialog box. The breakpoints you set in this window will be triggered by both read and write accesses; to change this, use the **Breakpoints** window. For more information, see *Data Log breakpoints*, page 103 and *Getting started using data logging*, page 187.

## Memory Save dialog box

The **Memory Save** dialog box is available by choosing **Debug>Memory>Save** or from the context menu in the **Memory** window.

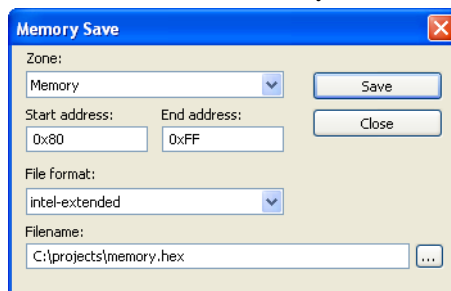

Use this dialog box to save the contents of a specified memory area to a file.

### Requirements

None; this dialog box is always available.

### Zone

Selects a memory zone, see *C-SPY memory zones*, page 128.

### Start address

Specify the start address of the memory range to be saved.

### End address

Specify the end address of the memory range to be saved.

### File format

Selects the file format to be used, which is Intel-extended by default.

**Filename**

Specify the destination file to be used; a browse button is available for your convenience.

**Save**

Saves the selected range of the memory zone to the specified file.

## Memory Restore dialog box

The **Memory Restore** dialog box is available by choosing **Debug>Memory>Restore** or from the context menu in the **Memory** window.

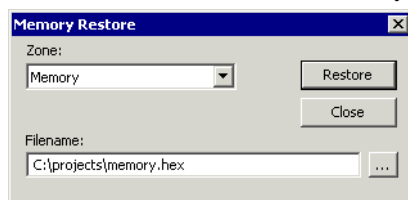

Use this dialog box to load the contents of a file in Intel-extended or Motorola S-record format to a specified memory zone.

**Requirements**

None; this dialog box is always available.

**Zone**

Selects a memory zone, see *C-SPY memory zones*, page 128.

**Filename**

Specify the file to be read; a browse button is available for your convenience.

**Restore**

Loads the contents of the specified file to the selected memory zone.

## Fill dialog box

The **Fill** dialog box is available from the context menu in the **Memory** window.

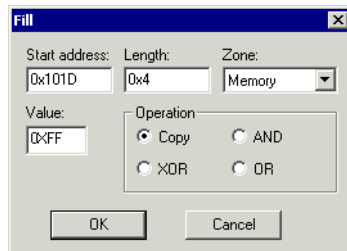

Use this dialog box to fill a specified area of memory with a value.

### Requirements

None; this dialog box is always available.

### Start address

Type the start address—in binary, octal, decimal, or hexadecimal notation.

### Length

Type the length—in binary, octal, decimal, or hexadecimal notation.

### Zone

Selects a memory zone, see *C-SPY memory zones*, page 128.

### Value

Type the 8-bit value to be used for filling each memory location.

### Operation

These are the available memory fill operations:

#### Copy

Value will be copied to the specified memory area.

#### AND

An AND operation will be performed between Value and the existing contents of memory before writing the result to memory.

#### XOR

An XOR operation will be performed between Value and the existing contents of memory before writing the result to memory.

OR

An OR operation will be performed between Value and the existing contents of memory before writing the result to memory.

## Symbolic Memory window

The **Symbolic Memory** window is available from the **View** menu during a debug session.

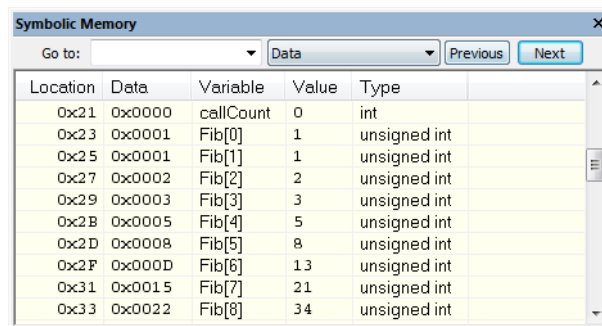

Location	Data	Variable	Value	Type
0x21	0x0000	callCount	0	int
0x23	0x0001	Fib[0]	1	unsigned int
0x25	0x0001	Fib[1]	1	unsigned int
0x27	0x0002	Fib[2]	2	unsigned int
0x29	0x0003	Fib[3]	3	unsigned int
0x2B	0x0005	Fib[4]	5	unsigned int
0x2D	0x0008	Fib[5]	8	unsigned int
0x2F	0x000D	Fib[6]	13	unsigned int
0x31	0x0015	Fib[7]	21	unsigned int
0x33	0x0022	Fib[8]	34	unsigned int

This window displays how variables with static storage duration, typically variables with file scope but also static variables in functions and classes, are laid out in memory. This can be useful for better understanding memory usage or for investigating problems caused by variables being overwritten, for example buffer overruns. Other areas of use are spotting alignment holes or for understanding problems caused by buffers being overwritten.



To view the memory corresponding to a variable, you can select it in the editor window and drag it to the **Symbolic Memory** window.

See also *Editing in C-SPY windows*, page 42.

### Requirements

None; this window is always available.

### Toolbar

The toolbar contains:

#### Go to

The memory location or symbol you want to view.

#### Zone

Selects a memory zone, see *C-SPY memory zones*, page 128.

**Previous**

Highlights the previous symbol in the display area.

**Next**

Highlights the next symbol in the display area.

**Display area**

This area contains these columns:

**Location**

The memory address.

**Data**

The memory contents in hexadecimal format. The data is grouped according to the size of the symbol. This column is editable.

**Variable**

The variable name; requires that the variable has a fixed memory location. Local variables are not displayed.

**Value**

The value of the variable. This column is editable.

**Type**

The type of the variable.

There are several different ways to navigate within the memory space:

- Text that is dropped in the window is interpreted as symbols
- The scroll bar at the right-side of the window
- The toolbar buttons **Next** and **Previous**
- The toolbar list box **Go to** can be used for locating specific locations or symbols.

**Note:** Rows are marked in red when the corresponding value has changed.

## Context menu

This context menu is available:

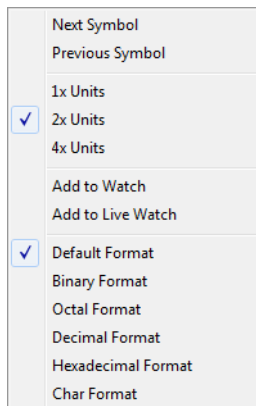

These commands are available:

### Next Symbol

Highlights the next symbol in the display area.

### Previous Symbol

Highlights the previous symbol in the display area.

### 1x Units

Displays the memory contents as single bytes. This applies only to rows which do not contain a variable.

### 2x Units

Displays the memory contents as 2-byte groups.

### 4x Units

Displays the memory contents as 4-byte groups.

### Add to Watch

Adds the selected symbol to the **Watch** window.

### Add to Live Watch

Adds the selected symbol to the **Live Watch** window.

### Default format

Displays the memory contents in the default format.

### Binary format

Displays the memory contents in binary format.



**Octal format**

Displays the memory contents in octal format.

**Decimal format**

Displays the memory contents in decimal format.

**Hexadecimal format**

Displays the memory contents in hexadecimal format.

**Char format**

Displays the memory contents in char format.

**Stack window**

The **Stack** window is available from the **View** menu.

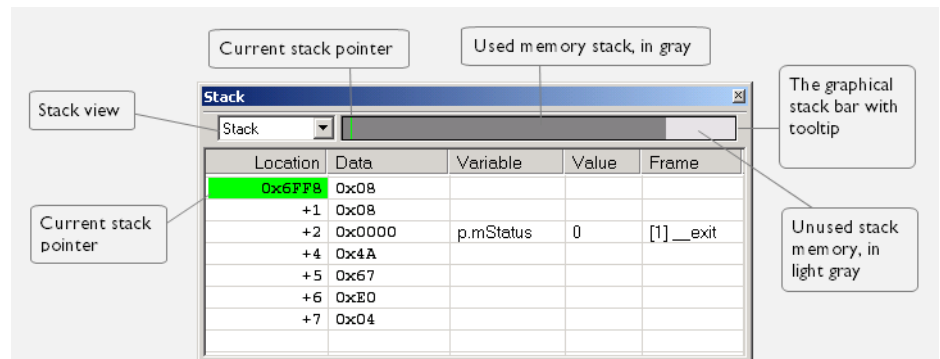

This window is a memory window that displays the contents of the stack. The graphical stack bar shows stack usage.

**Note:** By default, this window uses one physical breakpoint. For more information, see *Breakpoint consumers*, page 105.

For information about options specific to the **Stack** window, see the *IDE Project Management and Building Guide for STM8*.

**Requirements**

None; this window is always available.

## Toolbar

The toolbar contains:

### Stack

Selects which stack to view. This applies to microcontrollers with multiple stacks.

## The graphical stack bar

Displays the state of the stack graphically.

The left end of the stack bar represents the bottom of the stack, in other words, the position of the stack pointer when the stack is empty. The right end represents the end of the memory address range reserved for the stack. The graphical stack bar turns red when the stack usage exceeds a threshold that you can specify.

To enable the stack bar, choose **Tools>Options>Stack>Enable graphical stack display and stack usage tracking**. This means that the functionality needed to detect and warn about stack overflows is enabled.



Place the mouse pointer over the stack bar to get tooltip information about stack usage.

## Display area

This area contains these columns:

### Location

Displays the location in memory. The addresses are displayed in increasing order. The address referenced by the stack pointer, in other words the top of the stack, is highlighted in a green color.

### Data

Displays the contents of the memory unit at the given location. From the **Stack** window context menu, you can select how the data should be displayed; as a 1-, 2-, or 4-byte group of data.

### Variable

Displays the name of a variable, if there is a local variable at the given location. Variables are only displayed if they are declared locally in a function, and located on the stack and not in registers.

### Value

Displays the value of the variable.

### Type

Displays the data type of the variable.

**Frame**

Displays the name of the function that the call frame corresponds to.

**Context menu**

This context menu is available:

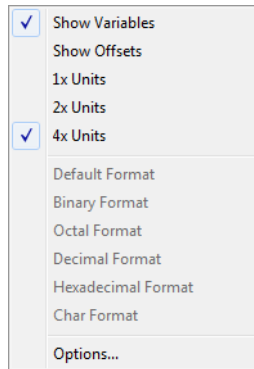

These commands are available:

**Show variables**

Displays separate columns named **Variables**, **Value**, and **Frame** in the **Stack** window. Variables located at memory addresses listed in the **Stack** window are displayed in these columns.

**Show offsets**

Displays locations in the **Location** column as offsets from the stack pointer. When deselected, locations are displayed as absolute addresses.

**1x Units**

Displays the memory contents as single bytes.

**2x Units**

Displays the memory contents as 2-byte groups.

**4x Units**

Displays the memory contents as 4-byte groups.

**Default Format,  
Binary Format,  
Octal Format,  
Decimal Format,  
Hexadecimal Format,  
Char Format**

Changes the display format of expressions. The display format setting affects different types of expressions in different ways. Your selection of display format is saved between debug sessions. These commands are available if a selected line in the window contains a variable.

The display format setting affects different types of expressions in these ways:

Variables	The display setting affects only the selected variable, not other variables.
Array elements	The display setting affects the complete array, that is, the same display format is used for each array element.
Structure fields	All elements with the same definition—the same field name and C declaration type—are affected by the display setting.

**Options**

Opens the **IDE Options** dialog box where you can set options specific to the **Stack** window, see the *IDE Project Management and Building Guide for STM8*.

## Registers window

The **Registers** windows are available from the **View** menu.

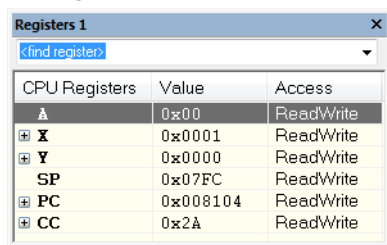

CPU Registers	Value	Access
<b>A</b>	0x00	ReadWrite
+ <b>X</b>	0x0001	ReadWrite
+ <b>Y</b>	0x0000	ReadWrite
<b>SP</b>	0x07FC	ReadWrite
+ <b>PC</b>	0x008104	ReadWrite
+ <b>CC</b>	0x2A	ReadWrite

These windows give an up-to-date display of the contents of the processor registers and special function registers, and allows you to edit the content of some of the registers. Optionally, you can choose to load either predefined register groups or your own user-defined groups.

You can open up to four instances of this window, which is very convenient if you want to keep track of different register groups.

See also *Editing in C-SPY windows*, page 42.

### To enable predefined register groups:

- 1 Select a device description file that suits your device, see *Selecting a device description file*, page 38.
- 2 Display the register groups that are defined in the device description file in the **Registers** window by right-clicking in the window and choosing **View Group** from the context menu.

For information about creating your own user-defined register groups, see *Defining application-specific register groups*, page 130.

## Requirements

None; this window is always available.

## Toolbar

The toolbar contains:

### <find register>

Specify the name of a register that you want to find. Press the Enter key and the first register group where this register is found is displayed. User-defined register groups are not searched. The register search box has a history depth of 20 search entries.

## Display area

Displays registers and their values. Some registers are expandable, which means that the register contains interesting bits or subgroups of bits.

If you drag a numerical value, a valid expression, or a register name from another part of the IDE to an editable value cell in a **Registers** window, the value will be changed to that of what you dragged. If you drop a register name somewhere else in the window, the window contents will change to display the first register group where this register is found.

### *Register group name*

The name of the register.

**Value**

The current value of the register. Every time C-SPY stops, a value that has changed since the last stop is highlighted. Some of the registers are editable. To edit the contents of an editable register, click it and modify its value. Press Esc to cancel the change.

To change the display format of the value, right-click on the register and choose **Format** from the context menu.

**Access**

The access type of the register. Some of the registers are read-only, some of the registers are write-only.

For the C-SPY Simulator and the C-SPY hardware debugger drivers, these additional support registers are available in the CPU Registers group:

<b>CYCLECOUNTER</b>	Cleared when an application is started or reset and is incremented with the number of used cycles during execution.
<b>CCSTEP</b>	Shows the number of used cycles during the last performed C/C++ source or assembler step.
<b>CCTIMER1</b> and <b>CCTIMER2</b>	Two <i>trip counts</i> that can be cleared manually at any given time. They are incremented with the number of used cycles during execution.

**Context menu**

This context menu is available:

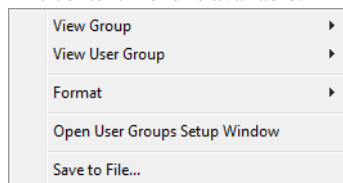

These commands are available:

**View Group**

Selects which predefined register group to display, by default **CPU Registers**. If some of your SFRs are missing, you can register your own SFRs in a Custom group, see *SFR Setup window*, page 153.

### View User Group

Selects which user-defined register group to display. For information about creating your own user-defined register groups, see *Defining application-specific register groups*, page 130.

### Format

Changes the display format for the contents of the register you clicked on. The display format setting affects different types of registers in different ways. Your selection of display format is saved between debug sessions.

### Open User Groups Setup Window

Opens a window where you can create your own user-defined register groups, see *Register User Groups Setup window*, page 151.

### Save to File

Opens a standard save dialog box to save the contents of the window to a tab-separated text file.

## Register User Groups Setup window

The **Register User Groups Setup** window is available from the **View** menu or from the context menu in the **Registers** windows.

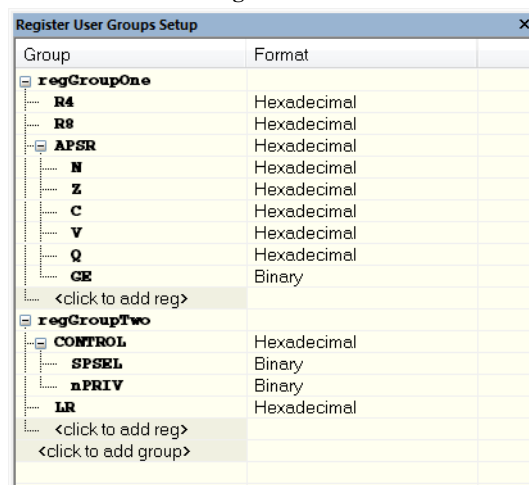

Use this window to define your own application-specific register groups. These register groups can then be viewed in the **Registers** windows.

Defining application-specific register groups means that the **Registers** windows can display just those registers that you need to watch for your current debugging task. This makes debugging much easier.

### Requirements

None; this window is always available.

### Display area

This area contains these columns:

#### Group

The names of register groups and the registers they contain. Clicking on <click to add group> or <click to add reg> and typing the name of a register group or register, adds new groups and registers, respectively. You can also drag a register name from another window in the IDE. Click a name to change it.

A dimmed register name indicates that it is not supported by the selected device.

#### Format

Shows the display format for the register's value. To change the display format of the value, right-click on the register and choose **Format** from the context menu. The selected format is used in all **Registers** windows.

### Context menu

This context menu is available:

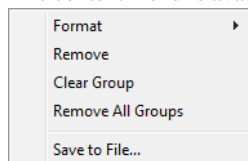

These commands are available:

#### Format

Changes the display format for the contents of the register you clicked on. The display format setting affects different types of registers in different ways. Your selection of display format is saved between debug sessions.

#### Remove

Removes the register or group you clicked on.

#### Clear Group

Removes all registers from the group you clicked on.



### Remove All Groups

Deletes all user-defined register groups from your project.

### Save to File

Opens a standard save dialog box to save the contents of the window to a tab-separated text file.

## SFR Setup window

The **SFR Setup** window is available from the **Project** menu.

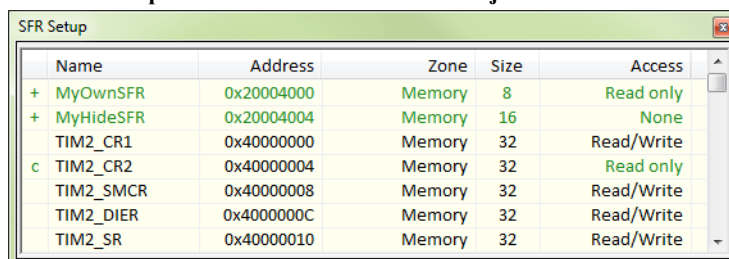

Name	Address	Zone	Size	Access
+ MyOwnSFR	0x20004000	Memory	8	Read only
+ MyHideSFR	0x20004004	Memory	16	None
TIM2_CR1	0x40000000	Memory	32	Read/Write
c TIM2_CR2	0x40000004	Memory	32	Read only
TIM2_SMCR	0x40000008	Memory	32	Read/Write
TIM2_DIER	0x4000000C	Memory	32	Read/Write
TIM2_SR	0x40000010	Memory	32	Read/Write

This window displays the currently defined SFRs that C-SPY has information about. You can choose to display only factory-defined or custom-defined SFRs, or both. If required, you can use the **Edit SFR** dialog box to customize the SFR definitions, see *Edit SFR dialog box*, page 156. For factory-defined SFRs (that is, retrieved from the `adf` file in use), you can only customize the access type.

To quickly find an SFR, drag a text or hexadecimal number string and drop in this window. If what you drop starts with a 0 (zero), the **Address** column is searched, otherwise the **Name** column is searched.

Any custom-defined SFRs are added to a dedicated register group called Custom, which you can choose to display in the **Registers** window. Your custom-defined SFRs are saved in `projectCustomSFR.sfr`. This file is automatically loaded in the IDE when you start C-SPY with a project whose name matches the prefix of the filename of the `sfr` file.

You can only add or modify SFRs when the C-SPY debugger is not running.

### Requirements

None; this window is always available.

## Display area

This area contains these columns:

### Status

A character that signals the status of the SFR, which can be one of:

blank, a factory-defined SFR.

C, a factory-defined SFR that has been modified.

+, a custom-defined SFR.

?, an SFR that is ignored for some reason. An SFR can be ignored when a factory-defined SFR has been modified, but the SFR is no longer available, or it is located somewhere else or with a different size. Typically, this might happen if you change to another device.

### Name

A unique name of the SFR.

### Address

The memory address of the SFR.

### Zone

Selects a memory zone, see *C-SPY memory zones*, page 128.

### Size

The size of the register, which can be any of **8**, **16**, **32**, or **64**.

### Access

The access type of the register, which can be one of **Read/Write**, **Read only**, **Write only**, or **None**.

You can click a name or an address to change the value. The hexadecimal 0x prefix for the address can be omitted, the value you enter will still be interpreted as hexadecimal. For example, if you enter 4567, you will get 0x4567.

You can click a column header to sort the SFRs according to the column property.

Color coding used in the display area:

- Green, which indicates that the corresponding value has changed
- Red, which indicates an ignored SFR.

## Context menu

This context menu is available:

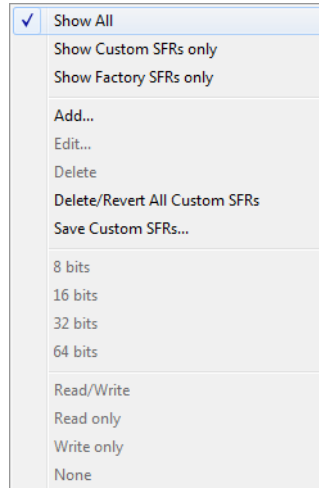

These commands are available:

### Show All

Shows all SFR.

### Show Custom SFRs only

Shows all custom-defined SFRs.

### Show Factory SFRs only

Shows all factory-defined SFRs retrieved from the ddf file.

### Add

Displays the **Edit SFR** dialog box where you can add a new SFR, see *Edit SFR dialog box*, page 156.

### Edit

Displays the **Edit SFR** dialog box where you can edit an SFR, see *Edit SFR dialog box*, page 156.

### Delete

Deletes an SFR. This command only works on custom-defined SFRs.

### Delete/revert All Custom SFRs

Deletes all custom-defined SFRs and reverts all modified factory-defined SFRs to their factory settings.

**Save Custom SFRs**

Opens a standard save dialog box to save all custom-defined SFRs.

**8|16|32|64 bits**

Selects display format for the selected SFR, which can be **8**, **16**, **32**, or **64** bits. Note that the display format can only be changed for custom-defined SFRs.

**Read/Write|Read only|Write only|None**

Selects the access type of the selected SFR, which can be **Read/Write**, **Read only**, **Write only**, or **None**. Note that for factory-defined SFRs, the default access type is indicated.

**Edit SFR dialog box**

The **Edit SFR** dialog box is available from the context menu in the **SFR Setup** window.

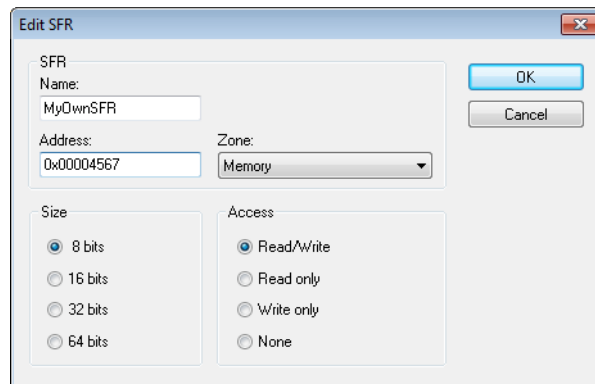

Definitions of the SFRs are retrieved from the device description file in use. Use this dialog box to either modify these factory-defined definitions or define new SFRs. See also *SFR Setup window*, page 153.

**Requirements**

None; this dialog box is always available.

**Name**

Specify the name of the SFR that you want to add or edit.

**Address**

Specify the address of the SFR that you want to add or edit. The hexadecimal 0x prefix for the address can be omitted, the value you enter will still be interpreted as hexadecimal. For example, if you enter 4567, you will get 0x4567.

**Zone**

Selects the memory zone for the SFR you want to add or edit. The list of zones is retrieved from the `ddf` file that is currently used.

**Size**

Selects the size of the SFR. Choose between **8**, **16**, **32**, or **64** bits. Note that the display format can only be changed for custom-defined SFRs.

**Access**

Selects the access type of the SFR. Choose between **Read/Write**, **Read only**, **Write only**, or **None**. Note that for factory-defined SFRs, the default access type is indicated.

## Memory Configuration dialog box, for the C-SPY simulator

The Memory Configuration dialog box is available from the C-SPY driver menu.

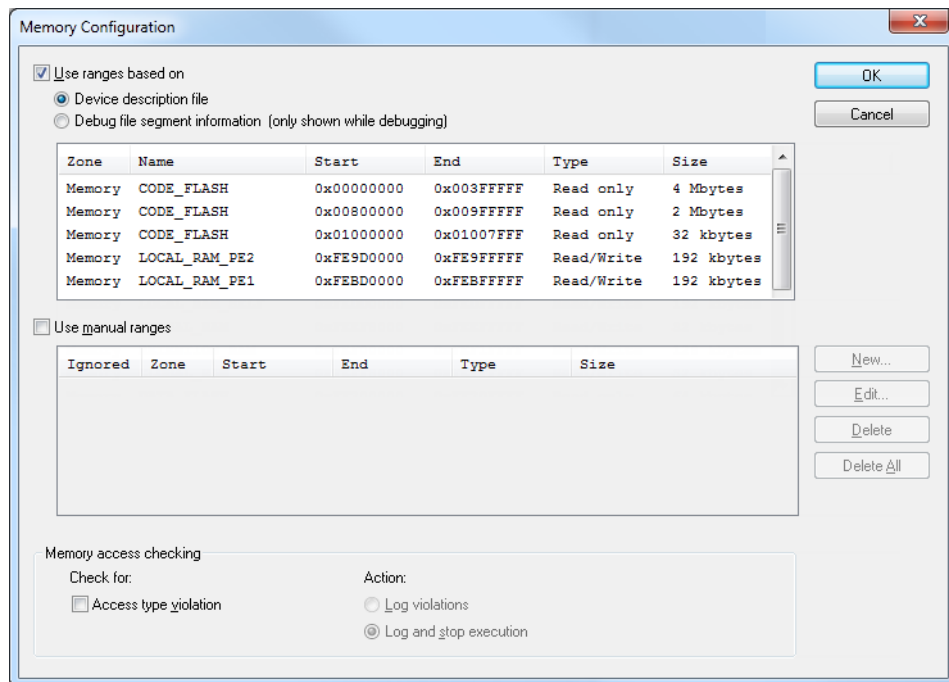

Use this dialog box to specify which set of memory address ranges to be used by C-SPY during debugging.

See also *Memory configuration for the C-SPY simulator*, page 129.

### Requirements

The C-SPY simulator.

### Use ranges based on

Specify if the memory configuration should be retrieved from a predefined configuration. Choose between:

#### Device description file

Retrieves the memory configuration from the device description file that you have specified. See *Selecting a device description file*, page 38.

This option is used by default.

**Debug file segment information**

Retrieves the memory configuration from the debug file, which has retrieved it from the linker configuration file. This information is only available during a debug session. The advantage of using this option is that the simulator can catch memory accesses outside the linked application.

Memory information is displayed in these columns:

**Zone**

The memory zone, see *C-SPY memory zones*, page 128.

**Name**

The name of the memory address range.

**Start**

The start address for the memory address range, in hexadecimal notation.

**End**

The end address for the memory address range, in hexadecimal notation.

**Type**

The access type of the memory address range.

**Size**

The size of the memory address range.

**Use manual ranges**

Specify your own ranges manually via the **Edit Memory Range** dialog box. To open this dialog box, click **New** to specify a new memory address range, or select an existing memory address range and click **Edit** to modify it. For more information, see *Edit Memory Range dialog box, for the C-SPY simulator*, page 160.

The ranges you define manually are saved between debug sessions.

An **X** in the column **Ignored** means that C-SPY has detected that the specified manual range is illegal, for example because it overlaps another range. C-SPY will not use such an area.

**Memory access checking**

**Check for** determines what to check for:

- **Access type violation.**

**Action** selects the action to be performed if an access violation occurs. Choose between:

- **Log violations**
- **Log and stop execution.**

Any violations are logged in the **Debug Log** window.

## Buttons

These buttons are available for the manual ranges:

### New

Opens the **Edit Memory Range** dialog box, where you can specify a new memory address range and associate an access type with it, see *Edit Memory Range dialog box, for the C-SPY simulator*, page 160.

### Edit

Opens the **Edit Memory Range** dialog box, where you can edit the selected memory address range. See *Edit Memory Range dialog box, for the C-SPY simulator*, page 160.

### Delete

Deletes the selected memory address range definition.

### Delete All

Deletes all defined memory address range definitions.

## Edit Memory Range dialog box, for the C-SPY simulator

The **Edit Memory Range** dialog box is available from the **Memory Configuration** dialog box.

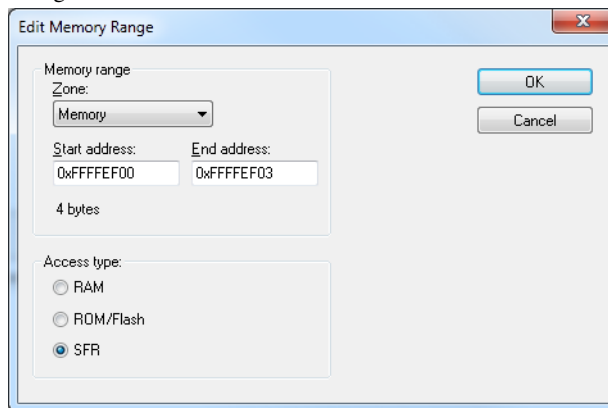

Use this dialog box to specify your own memory address ranges, and their access types.

See also *Memory Configuration dialog box, for the C-SPY simulator*, page 158



**Requirements**

The C-SPY simulator.

**Memory range**

Defines the memory address range specific to your device:

**Zone**

Selects a memory zones, see *C-SPY memory zones*, page 128.

**Start address**

Specify the start address for the memory address range, in hexadecimal notation.

**End address**

Specify the end address for the memory address range, in hexadecimal notation.

**Access type**

Selects an access type for the memory address range. Choose between:

- **RAM**, for read/write memory
- **ROM/Flash**, for read-only memory
- **SFR**, for SFR read/write memory.



# Part 2. Analyzing your application

This part of the *C-SPY® Debugging Guide for STM8* includes these chapters:

- Trace
- The application timeline
- Profiling
- Code coverage

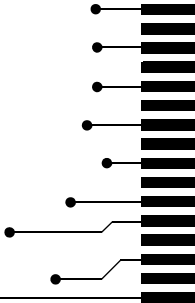

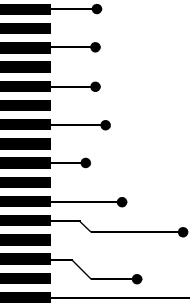

# Trace

- Introduction to using trace
- Collecting and using trace data
- Reference information on trace

---

## Introduction to using trace

These topics are covered:

- Reasons for using trace
- Briefly about trace
- Requirements for using trace

See also:

- *Getting started using data logging*, page 187
- *Getting started using interrupt logging*, page 236
- *Profiling*, page 211

### REASONS FOR USING TRACE

By using trace, you can inspect the program flow up to a specific state, for instance an application crash, and use the trace data to locate the origin of the problem. Trace data can be useful for locating programming errors that have irregular symptoms and occur sporadically.

### BRIEFLY ABOUT TRACE

To use trace in C-SPY requires that your target system can generate trace data. Once generated, C-SPY can collect it and you can visualize and analyze the data in various windows and dialog boxes.

### Trace features in C-SPY

In C-SPY, you can use the trace-related windows **Trace**, **Function Trace**, **Timeline**, and **Find in Trace**.

Depending on your C-SPY driver, you:

- Can set various types of trace breakpoints to control the collection of trace data.

- Have access to windows such as the **Interrupt Log**, **Interrupt Log Summary**, **Data Log**, and **Data Log Summary**.

In addition, several other features in C-SPY also use trace data, features such as Profiling, Code coverage, and Instruction profiling.

## REQUIREMENTS FOR USING TRACE

The C-SPY simulator supports trace-related functionality, and there are no specific requirements.

To use trace in your hardware debugger systems you need:

- The C-SPY STice driver, not using the SWIM interface.

**Note:** The specific set of debug components you are using (hardware, a debug probe, and a C-SPY driver) determine which trace features in C-SPY that are supported.

---

## Collecting and using trace data

These tasks are covered:

- Getting started with trace
- Trace data collection using breakpoints
- Searching in trace data
- Browsing through trace data.

### GETTING STARTED WITH TRACE



- 1 Open the **Trace** window—available from the driver-specific menu—and click the **Activate** button to enable collecting trace data.
- 2 Start the execution. When the execution stops, for example because a breakpoint is triggered, trace data is displayed in the **Trace** window. For more information about the window, see *Trace window*, page 170.

### TRACE DATA COLLECTION USING BREAKPOINTS

A convenient way to collect trace data between two execution points is to start and stop the data collection using dedicated breakpoints. Choose between these alternatives:

- In the editor or **Disassembly** window, position your insertion point, right-click, and toggle a **Trace Start** or **Trace Stop** breakpoint from the context menu.
- In the **Breakpoints** window, choose **Trace Start** or **Trace Stop**.
- The C-SPY system macros `__setTraceStartBreak` and `__setTraceStopBreak` can also be used.

For more information about these breakpoints, see *Trace Start breakpoints dialog box*, page 176 and *Trace Stop breakpoints dialog box*, page 177, respectively.

**Note:** Collecting trace data using breakpoints is only supported by the C-SPY simulator.

## SEARCHING IN TRACE DATA

When you have collected trace data, you can perform searches in the collected data to locate the parts of your code or data that you are interested in, for example, a specific interrupt or accesses of a specific variable.

You specify the search criteria in the **Find in Trace** dialog box and view the result in the **Find in Trace** window.

The **Find in Trace** window is very similar to the **Trace** window, showing the same columns and data, but *only* those rows that match the specified search criteria.

Double-clicking an item in the **Find in Trace** window brings up the same item in the **Trace** window.

### To search in your trace data:



**1** On the **Trace** window toolbar, click the **Find** button.

**2** In the **Find in Trace** dialog box, specify your search criteria.

Typically, you can choose to search for:

- A specific piece of text, for which you can apply further search criteria
- An address range
- A combination of these, like a specific piece of text within a specific address range.

For more information about the various options, see *Find in Trace dialog box*, page 180.

**3** When you have specified your search criteria, click **Find**. The **Find in Trace** window is displayed, which means you can start analyzing the trace data. For more information, see *Find in Trace window*, page 181.

## BROWSING THROUGH TRACE DATA

To follow the execution history, simply look and scroll in the **Trace** window. Alternatively, you can enter *browse mode*.



To enter browse mode, double-click an item in the **Trace** window, or click the **Browse** toolbar button.

The selected item turns yellow and the source and disassembly windows will highlight the corresponding location. You can now move around in the trace data using the up and down arrow keys, or by scrolling and clicking; the source and **Disassembly** windows

will be updated to show the corresponding location. This is like stepping backward and forward through the execution history.

Double-click again to leave browse mode.

---

## Reference information on trace

Reference information about:

- *Trace Settings dialog box*, page 168
- *Trace window*, page 170
- *Function Trace window*, page 175
- *Trace Start breakpoints dialog box*, page 176
- *Trace Stop breakpoints dialog box*, page 177
- *Trace Expressions window*, page 178
- *Find in Trace dialog box*, page 180
- *Find in Trace window*, page 181.

## Trace Settings dialog box

The **Trace Settings** dialog box is available from the **STice** menu.

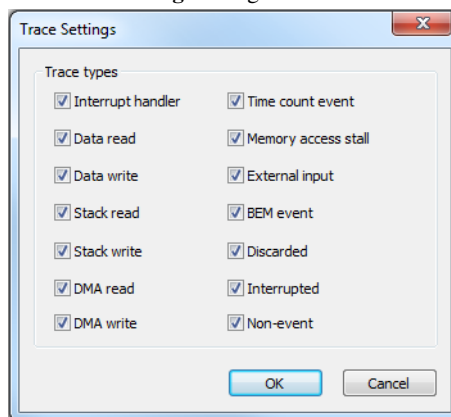

Use this dialog box to determine which trace data is displayed in the **Trace** window.



## Requirements

One of these alternatives:

- The C-SPY Simulator
- The C-SPY STice driver, not using the SWIM interface.

## Trace types

Choose between:

<b>Interrupt handler</b>	Displays interrupt handler entry cycles in the <b>Instruction event</b> column in the <b>Trace</b> window.
<b>Data read</b>	Displays data memory read cycles in the <b>R event</b> column in the <b>Trace</b> window.
<b>Data write</b>	Displays data memory write cycles in the <b>W event</b> column in the <b>Trace</b> window.
<b>Stack read</b>	Displays stack read cycles in the <b>R event</b> column in the <b>Trace</b> window.
<b>Stack write</b>	Displays stack write cycles in the <b>W event</b> column in the <b>Trace</b> window.
<b>DMA read</b>	Displays direct memory read cycles in the <b>R event</b> column in the <b>Trace</b> window.
<b>DMA write</b>	Displays direct memory write cycles in the <b>W event</b> column in the <b>Trace</b> window.
<b>Time count event</b>	Displays timestamp event cycles in the <b>Time event</b> column in the <b>Trace</b> window.
<b>Memory access stall</b>	Displays memory access stall cycles in the <b>R event</b> or <b>W event</b> column in the <b>Trace</b> window.
<b>External input</b>	Displays external input cycles in the <b>Trigger</b> or <b>AI</b> column in the <b>Trace</b> window.
<b>BEM event</b>	Displays BEM event cycles in the <b>BEM</b> column in the <b>Trace</b> window.
<b>Discarded</b>	Displays discarded cycles in the <b>Instruction event</b> column in the <b>Trace</b> window.
<b>Interrupted</b>	Displays interrupted instruction cycles in the <b>Instruction event</b> column in the <b>Trace</b> window.

**Non-event** Displays cycles with no event. If this option is selected, a record might be displayed even if it does not contain any event.

## Trace window

The **Trace** window is available from the C-SPY driver menu.

This window displays the collected trace data.

See also *Collecting and using trace data*, page 166.

### Requirements

One of these alternatives:

- The C-SPY Simulator
- The C-SPY STice driver, not using the SWIM interface.

### Trace toolbar

The toolbar in the **Trace** window and in the **Function Trace** window contains:



#### Enable/Disable

Enables and disables collecting and viewing trace data in this window. This button is not available in the **Function Trace** window.



#### Clear trace data

Clears the trace buffer. Both the **Trace** window and the **Function Trace** window are cleared.



#### Toggle source

Toggles the **Trace** column between showing only disassembly or disassembly together with the corresponding source code.



#### Browse

Toggles browse mode on or off for a selected item in the **Trace** window.



#### Find

Displays a dialog box where you can perform a search, see *Find in Trace dialog box*, page 180.



#### Save

Displays a standard **Save As** dialog box where you can save the collected trace data to a text file, with tab-separated columns.



#### Edit Settings

In the C-SPY simulator, this button is not enabled.

For the STice emulator, this button displays the **Trace Settings** dialog box, see *Trace Settings dialog box*, page 168.

### Edit Expressions (C-SPY simulator only)



Opens the **Trace Expressions** window, see *Trace Expressions window*, page 178.



### Progress bar

When a large amount of trace data has been collected, there might be a delay before all of it has been processed and can be displayed. The progress bar reflects that processing.

### Display area (in the C-SPY simulator)

This area displays a collected sequence of executed machine instructions. In addition, the window can display trace data for expressions.

#	Cycles	Trace	callCount
1396	2766	FFF80574 MOV.L SP, R2	10
1397	2767	FFF80576 MOV #0x01:4, R1	10
1398	2771	FFF80578 BSR.A __DebugBreak	10
__DebugBreak:			
1399	2777	FFF804E0 RTS	10
1400	2780	FFF8057C BRA.B 0xFFF80572	10
1401	2781	FFF80572 MOV.L R6, [SP]	10
1402	2782	FFF80574 MOV.L SP, R2	10
1403	2783	FFF80576 MOV #0x01:4, R1	10

This area contains these columns for the C-SPY simulator:

#### #

A serial number for each row in the trace buffer. Simplifies the navigation within the buffer.

#### Cycles

The number of cycles elapsed to this point.

#### Trace

The collected sequence of executed machine instructions. Optionally, the corresponding source code can also be displayed.

### Expression

Each expression you have defined to be displayed appears in a separate column. Each entry in the expression column displays the value *after* executing the instruction on the same row. You specify the expressions for which you want to collect trace data in the **Trace Expressions** window, see *Trace Expressions window*, page 178.

A red-colored row indicates that the previous row and the red row are not consecutive. This means that there is a gap in the collected trace data, for example because trace data has been lost due to an overflow.

### Display area (in the C-SPY STice driver)

This area displays a collected sequence of executed machine instructions

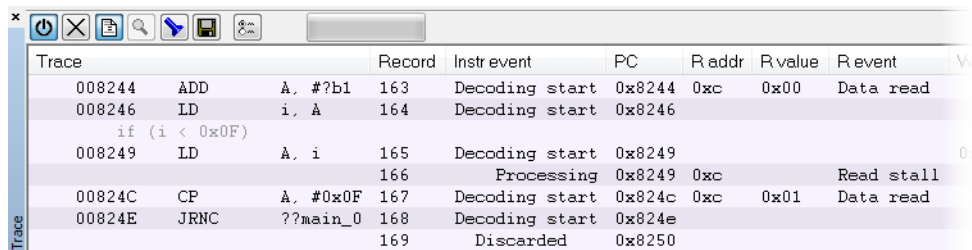

Trace	Record	Instr event	PC	R addr	R value	R event	W	
008244	ADD	A, #?b1	163	Decoding start	0x8244	0xc	0x00	Data read
008246	LD	i, A	164	Decoding start	0x8246			
if (i < 0x0F)								
008249	LD	A, i	165	Decoding start	0x8249			
			166	Processing	0x8249	0xc		Read stall
00824C	CP	A, #0x0F	167	Decoding start	0x824c	0xc	0x01	Data read
00824E	JRNC	??main_0	168	Decoding start	0x824e			
			169	Discarded	0x8250			

This area contains these columns for the C-SPY STice driver:

#### Trace

The collected sequence of executed machine instructions. Optionally, the corresponding source code can also be displayed.

#### Record

A sequential trace record number.

#### Instruction event

The type of instruction trace event, one of Decoding start, Interrupt handler, Discarded, Interrupted, Processing, or Extra record.

#### PC

The execution address of the trace record.

#### R addr

The address of a data read event, including locations for instruction decoding.

#### R value

The data value of a data read event.

**R event**

Special events during a data read event, one of Data read, DMA read, Stack read, or Read stall.

**W addr**

The address of a data write event.

**W value**

The data value of a data write event.

**W event**

Special events during a data write event, one of Data write, DMA write, Stack write, or Write stall.

**Time**

The timestamp for the event in milliseconds.

**Irq**

The name of the starting interrupt, for example reset, trap, or irqN.

**Time event**

An event indicating that the timestamp counter has been affected. When there is an overflow, Restart is displayed, and when there is a discontinuity, Discontinuity is displayed.

**Trace event**

An event indicating a trace discontinuity, for example when the target is started after a reset.

**Trigger\***

An event indicating input from an external trigger.

**AI\***

An event indicating input from the probe analyzer.

**BEM\***

Indicates that a BEM event has occurred.

\* For more information about triggers, probe analyzers, and BEM, see the documentation from STMicroelectronics.

A red-colored row indicates that the previous row and the red row are not consecutive. This means that there is a gap in the collected trace data, for example because trace data has been lost due to an overflow.

## Context menu

This context menu is available:

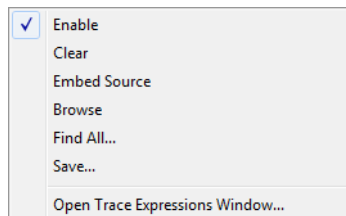

**Note:** The contents of this menu are dynamic and depend on which features that your combination of software and hardware supports. However, the list of menu commands below is complete and covers all possible commands.

These commands are available:

### Enable

Enables and disables collecting and viewing trace data in this window.

### Clear

Clears the trace buffer. Both the **Trace** window and the **Function Trace** window are cleared.

### Embed source

Toggles the **Trace** column between showing only disassembly or disassembly together with the corresponding source code.

### Browse

Toggles browse mode on or off for a selected item in the **Trace** window.

### Find All

Displays a dialog box where you can perform a search in the Trace window, see *Find in Trace dialog box*, page 180. The search results are displayed in the **Find in Trace** window—available by choosing the **View>Messages** command, see *Find in Trace window*, page 181.

### Save

Displays a standard **Save As** dialog box where you can save the collected trace data to a text file, with tab-separated columns.

### Open Trace Expressions Window

Opens the **Trace Expressions** window, see *Trace Expressions window*, page 178.

## Function Trace window

The **Function Trace** window is available from the C-SPY driver menu during a debug session.

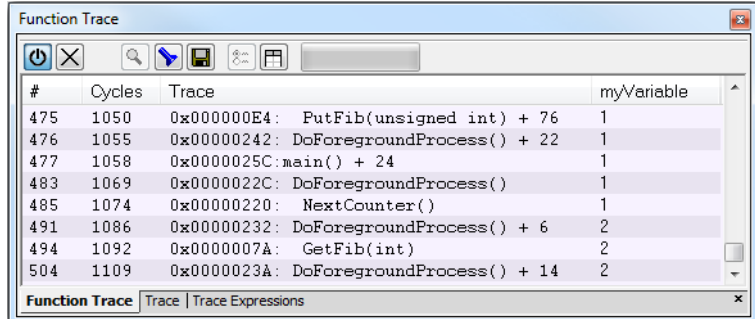

This window displays a subset of the trace data displayed in the **Trace** window. Instead of displaying all rows, the **Function Trace** window shows:

- The functions called or returned to, instead of the traced instruction
- The corresponding trace data.

### Requirements

One of these alternatives:

- The C-SPY Simulator
- The C-SPY STice driver, not using the SWIM interface.

### Toolbar

For information about the toolbar, see *Trace window*, page 170.

### Display area

For information about the columns in the display area, see *Trace window*, page 170

## Trace Start breakpoints dialog box

The **Trace Start** dialog box is available from the context menu that appears when you right-click in the **Breakpoints** window.

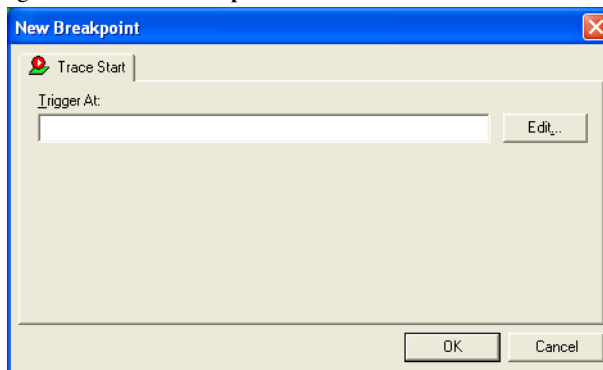

Use this dialog box to set a Trace Start breakpoint where you want to start collecting trace data. If you want to collect trace data only for a specific range, you must also set a Trace Stop breakpoint where you want to stop collecting data.

See also *Trace Stop breakpoints dialog box*, page 177 and *Trace data collection using breakpoints*, page 166.

### To set a Trace Start breakpoint:

- 1 In the editor or **Disassembly** window, right-click and choose **Trace Start** from the context menu.  
Alternatively, open the **Breakpoints** window by choosing **View>Breakpoints**.
- 2 In the **Breakpoints** window, right-click and choose **New Breakpoint>Trace Start**.  
Alternatively, to modify an existing breakpoint, select a breakpoint in the **Breakpoints** window and choose **Edit** on the context menu.
- 3 In the **Trigger At** text box, specify an expression, an absolute address, or a source location. Click **OK**.
- 4 When the breakpoint is triggered, the trace data collection starts.

### Requirements

The C-SPY simulator.

### Trigger at

Specify the code location of the breakpoint. Alternatively, click the **Edit** button to open the **Enter Location** dialog box, see *Enter Location dialog box*, page 124.



## Trace Stop breakpoints dialog box

The **Trace Stop** dialog box is available from the context menu that appears when you right-click in the **Breakpoints** window.

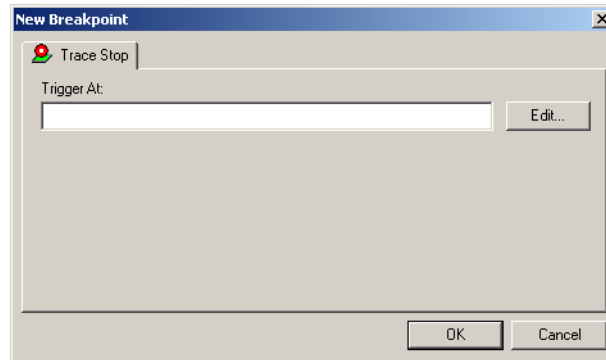

Use this dialog box to set a Trace Stop breakpoint where you want to stop collecting trace data. If you want to collect trace data only for a specific range, you might also need to set a Trace Start breakpoint where you want to start collecting data.

See also *Trace Start breakpoints dialog box*, page 176 and *Trace data collection using breakpoints*, page 166.

### To set a Trace Stop breakpoint:

- 1 In the editor or **Disassembly** window, right-click and choose **Trace Stop** from the context menu.  
Alternatively, open the **Breakpoints** window by choosing **View>Breakpoints**.
- 2 In the **Breakpoints** window, right-click and choose **New Breakpoint>Trace Stop**.  
Alternatively, to modify an existing breakpoint, select a breakpoint in the **Breakpoints** window and choose **Edit** on the context menu.
- 3 In the **Trigger At** text box, specify an expression, an absolute address, or a source location. Click **OK**.
- 4 When the breakpoint is triggered, the trace data collection stops.

### Requirements

The C-SPY simulator.

### Trigger at

Specify the code location of the breakpoint. Alternatively, click the **Edit** button to open the **Enter Location** dialog box, see *Enter Location dialog box*, page 124.

## Trace Expressions window

The **Trace Expressions** window is available from the **Trace** window toolbar.

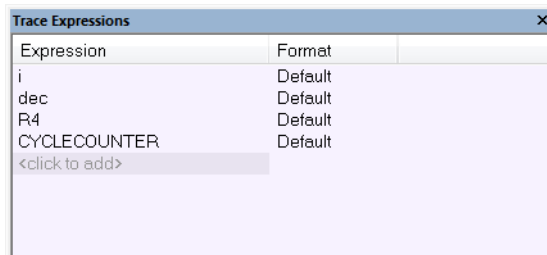

Use this window to specify, for example, a specific variable (or an expression) for which you want to collect trace data.

### Requirements

The C-SPY simulator.

### Display area

Use the display area to specify expressions for which you want to collect trace data:

#### Expression

Specify any expression that you want to collect data from. You can specify any expression that can be evaluated, such as variables and registers.

#### Format

Shows which display format that is used for each expression. Note that you can change display format via the context menu.

Each row in this area will appear as an extra column in the **Trace** window.

## Context menu

This context menu is available:

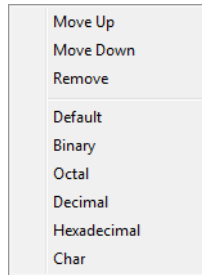

These commands are available:

### **Move Up**

Moves the selected expression upward in the window.

### **Move Down**

Moves the selected expression downward in the window.

### **Remove**

Removes the selected expression from the window.

### **Default Format,**

### **Binary Format,**

### **Octal Format,**

### **Decimal Format,**

### **Hexadecimal Format,**

### **Char Format**

Changes the display format of expressions. The display format setting affects different types of expressions in different ways. Your selection of display format is saved between debug sessions. These commands are available if a selected line in the window contains a variable.

The display format setting affects different types of expressions in these ways:

Variables	The display setting affects only the selected variable, not other variables.
Array elements	The display setting affects the complete array, that is, the same display format is used for each array element.
Structure fields	All elements with the same definition—the same field name and C declaration type—are affected by the display setting.

## Find in Trace dialog box

The **Find in Trace** dialog box is available by clicking the **Find** button on the **Trace** window toolbar or by choosing **Edit>Find and Replace>Find**.

Note that the **Edit>Find and Replace>Find** command is context-dependent. It displays the **Find in Trace** dialog box if the **Trace** window is the current window or the **Find** dialog box if the editor window is the current window.

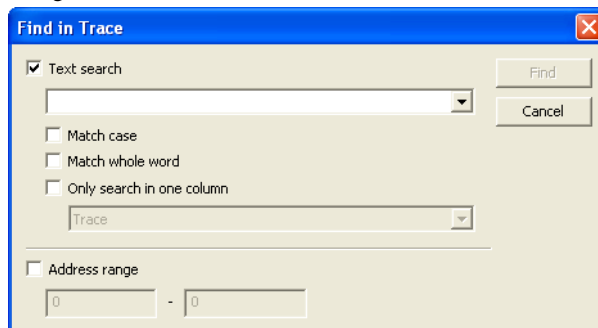

Use this dialog box to specify the search criteria for advanced searches in the trace data.

The search results are displayed in the **Find in Trace** window—available by choosing the **View>Messages** command, see *Find in Trace window*, page 181.

See also *Searching in trace data*, page 167.

### Requirements

One of these alternatives:

- The C-SPY Simulator
- The C-SPY STice driver, not using the SWIM interface.

### Text search

Specify the string you want to search for. To specify the search criteria, choose between:

#### Match Case

Searches only for occurrences that exactly match the case of the specified text. Otherwise **int** will also find **INT** and **Int** and so on.

#### Match whole word

Searches only for the string when it occurs as a separate word. Otherwise **int** will also find **print**, **sprintf** and so on.

#### Only search in one column

Searches only in the column you selected from the drop-down list.

## Address Range

Specify the address range you want to display or search. The trace data within the address range is displayed. If you also have specified a text string in the **Text search** field, the text string is searched for within the address range.

## Find in Trace window

The **Find in Trace** window is available from the **View>Messages** menu. Alternatively, it is automatically displayed when you perform a search using the **Find in Trace** dialog box or perform a search using the **Find in Trace** command available from the context menu in the editor window.

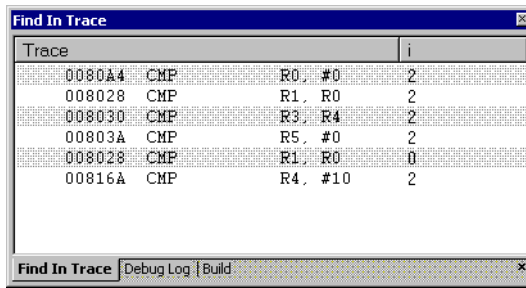

This window displays the result of searches in the trace data. Double-click an item in the **Find in Trace** window to bring up the same item in the **Trace** window.

Before you can view any trace data, you must specify the search criteria in the **Find in Trace** dialog box, see *Find in Trace dialog box*, page 180.

See also *Searching in trace data*, page 167.

## Requirements

One of these alternatives:

- The C-SPY Simulator
- The C-SPY STice driver, not using the SWIM interface.

## Display area

The **Find in Trace** window looks like the **Trace** window and shows the same columns and data, but *only* those rows that match the specified search criteria.



# The application timeline

- Introduction to analyzing your application's timeline
- Analyzing your application's timeline
- Reference information on application timeline

---

## Introduction to analyzing your application's timeline

These topics are covered:

- Briefly about analyzing the timeline
- Requirements for timeline support

See also:

- *Trace*, page 165

### BRIEFLY ABOUT ANALYZING THE TIMELINE

C-SPY can provide information for various aspects of your application, collected when the application is running. This can help you to analyze the application's behavior.

You can view the timeline information in different representations:

- As different *graphs* that correlate with the running application in relation to a shared *time axis*. The graphs appear either in the **Timeline** window or the **Sampled graphs** window, depending on the source of the data.
- As detailed logs
- As summaries of the logs.

Timeline information can be provided for:

**Call stack** Can be represented in the **Timeline** window, as a graph that displays the sequence of function calls and returns collected by the trace system. You get timing information between the function invocations.

Note that there is also a related **Call Stack** window and a **Function Trace** window, see *Call Stack window*, page 67 and *Function Trace window*, page 175, respectively.

Data logging	<p>Based on data logs collected by the trace system for up to four different variables or address ranges, specified by means of <i>Data Log breakpoints</i>. Choose to display the data logs:</p> <ul style="list-style-type: none"> <li>● In the <b>Timeline</b> window, as a graph of how the values change over time.</li> <li>● In the <b>Data Log</b> window and the <b>Data Log Summary</b> window.</li> </ul>
Data sampling	<p>Based on samples for up to four different variables. Choose to display the data logs:</p> <ul style="list-style-type: none"> <li>● In the <b>Sampled Graphs</b> window, as a graph of how the values change over time.</li> <li>● In the <b>Data Sample</b> window.</li> </ul> <p>Data sampling gives an indication of the data value over a length of time. Because it is a sampled value, data sampling is best suited for slow-changing data.</p>
Interrupt logging	<p>Based on interrupt logs collected by the trace system. Choose to display the interrupt logs:</p> <ul style="list-style-type: none"> <li>● In the <b>Timeline</b> window, as a graph of the interrupt events during the execution of your application.</li> <li>● In the <b>Interrupt Log</b> window and the <b>Interrupt Log Summary</b> window.</li> </ul> <p>Interrupt logging can, for example, help you locate which interrupts you can fine-tune to make your application more efficient. For more information, see the chapter <i>Interrupts</i>.</p>

## REQUIREMENTS FOR TIMELINE SUPPORT

Depending on the capabilities of the hardware, the debug probe, and the C-SPY driver you are using, trace-based timeline information is supported for:

Target system	Call Stack	Data logging	Data sampling	Interrupt logging
C-SPY simulator	Yes	Yes	Yes	Yes
ST-LINK, and STice using SWIM mode	—	—	Yes	—
STice	Yes	—	Yes	—

Table 8: Supported graphs in the Timeline window

For more information about requirements related to trace data, see *Requirements for using trace*, page 166.



## Analyzing your application's timeline

These tasks are covered:

- *Displaying a graph in the Timeline window*, page 185
- *Navigating in the graphs*, page 185
- *Analyzing performance using the graph data*, page 186
- *Getting started using data logging*, page 187
- *Getting started using data sampling*, page 188

See also:

- *Using the interrupt system*, page 233

### DISPLAYING A GRAPH IN THE TIMELINE WINDOW

The **Timeline** window can display several graphs; follow this example procedure to display any of these graphs. For an overview of the graphs and what they display, see *Briefly about analyzing the timeline*, page 183.

- 1** Choose **Timeline** from the C-SPY driver menu to open the **Timeline** window.
- 2** In the **Timeline** window, right-click in the window and choose **Select graphs** from the context menu to select which graphs to be displayed.
- 3** In the **Timeline** window, right-click in the graph area and choose **Enable** from the context menu to enable a specific graph.
- 4** For the Data Log graph, you must set a Data Log breakpoint for each variable you want a graphical representation of in the **Timeline** window. See *Data Log breakpoints dialog box*, page 122.
- 5** Click **Go** on the toolbar to start executing your application. The graphs that you have enabled appear.

### NAVIGATING IN THE GRAPHS

After you have performed the steps in *Displaying a graph in the Timeline window*, page 185, you can use any of these alternatives to navigate in the graph:

- Right-click and from the context menu choose **Zoom In** or **Zoom Out**. Alternatively, use the + and – keys. The graph zooms in or out depending on which command you used.
- Right-click in the graph and from the context menu choose **Navigate** and the appropriate command to move backwards and forwards on the graph. Alternatively, use any of the shortcut keys: arrow keys, Home, End, and Ctrl+End.

- Double-click on a sample of interest to highlight the corresponding source code in the editor window and in the **Disassembly** window.
- Click on the graph and drag to select a time interval, which will correlate to the running application. The selection extends vertically over all graphs, but appears highlighted in a darker color for the selected graph. Press Enter or right-click and from the context menu choose **Zoom>Zoom to Selection**. The selection zooms in. Use the navigation keys in combination with the Shift key to extend the selection.

## ANALYZING PERFORMANCE USING THE GRAPH DATA

The **Timeline** window provides a set of tools for analyzing the graph data.

- 1 In the **Timeline** window, right-click and choose **Time Axis Unit** from the context menu. Select which unit to be used on the time axis; choose between **Seconds** and **Cycles**. If **Cycles** is not available, the graphs are based on different clock sources.
- 2 Execute your application to display a graph, following the steps described in *Displaying a graph in the Timeline window*, page 185.
- 3 Whenever execution stops, point at the graph with the mouse pointer to get detailed tooltip information for that location.

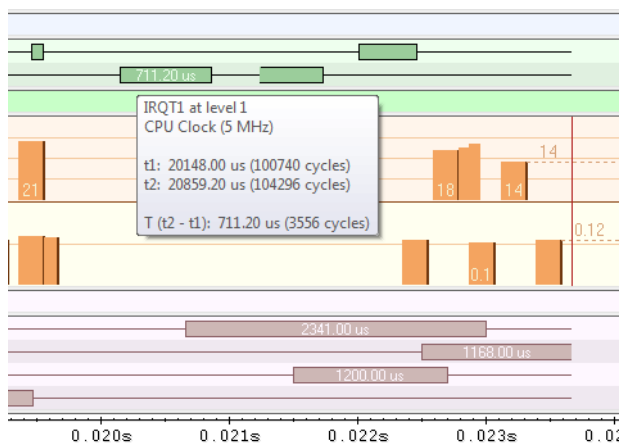

Note that if you have enabled several graphs, you can move the mouse pointer over the different graphs to get graph-specific information.

- 4 Click in the graph and drag to select a time interval. Point in the graph with the mouse pointer to get timing information for the selection.

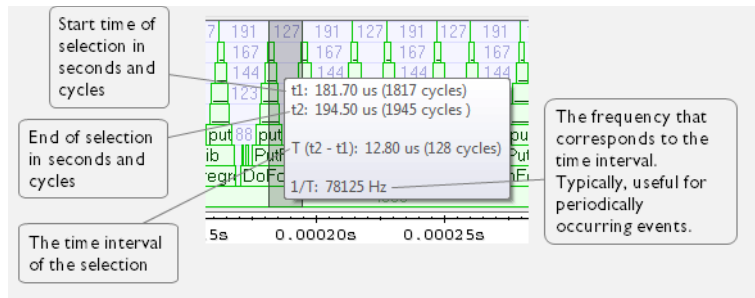

## GETTING STARTED USING DATA LOGGING

- 1 To set a data log breakpoint, use one of these methods:
  - In the **Breakpoints** window, right-click and choose **New Breakpoint>Data Log** to open the breakpoints dialog box. Set a breakpoint on the memory location that you want to collect log information for. This can be specified either as a variable or as an address.
  - In the **Memory** window, select a memory area, right-click and choose **Set Data Log Breakpoint** from the context menu. A breakpoint is set on the start address of the selection.
  - In the editor window, select a variable, right-click and choose **Set Data Log Breakpoint** from the context menu. The breakpoint will be set on the part of the variable that the microcontroller can access using one instruction.

You can set up to four data log breakpoints. For more information about data log breakpoints, see *Data Log breakpoints*, page 103.
- 2 Choose **C-SPY driver>Data Log** to open the **Data Log** window. Optionally, you can also choose:
  - **C-SPY driver>Data Log Summary** to open the **Data Log Summary** window
  - **C-SPY driver>Timeline** to open the **Timeline** window to view the Data Log graph.
- 3 From the context menu, available in the **Data Log** window, choose **Enable** to enable the logging.
- 4 Start executing your application program to collect the log information.
- 5 To view the data log information, look in the **Data Log** window, the **Data Log Summary** window, or the Data graph in the **Timeline** window.
- 6 If you want to save the log or summary to a file, choose **Save to log file** from the context menu in the window in question.

- 7 To disable data logging, choose **Disable** from the context menu in each window where you have enabled it.

## GETTING STARTED USING DATA SAMPLING

- 1 Choose **C-SPY driver>Data Sample Setup** to open the **Data Sample Setup** window.
- 2 In the **Data Sample Setup** window, perform these actions:
  - In the **Expression** column, type the name of the variable for which you want to sample data. The variable must be an integral type with a maximum size of 32 bits and you can specify up to four variables. Make sure that the checkbox is selected for the variable that you want to sample.
  - In the **Sampling interval** column, type the number of milliseconds to pass between the samples.
- 3 To view the result of data sampling, you must enable it in the window in question:
  - Choose **C-SPY driver>Data Sample** to open the **Data Sample** window. From the context menu, choose **Enable**.
  - Choose **C-SPY driver>Sampled Graphs** to open the **Sampled Graphs** window. From the context menu, choose **Enable**.
- 4 Start executing your application program. This starts the data sampling. When the execution stops, for example because a breakpoint is triggered, you can view the result either in the **Data Sample** window or as the Data Sample graph in the **Sampled Graphs** window
- 5 If you want to save the log or summary to a file, choose **Save to log file** from the context menu in the window in question.
- 6 To disable data sampling, choose **Disable** from the context menu in each window where you have enabled it.

---

## Reference information on application timeline

Reference information about:

- *Timeline window—Call Stack graph*, page 189
- *Timeline window—Data Log graph*, page 192
- *Data Log window*, page 196
- *Data Log Summary window*, page 199
- *Sampled Graphs window*, page 202
- *Data Sample Setup window*, page 205

- *Data Sample window*, page 207
- *Viewing Range dialog box*, page 209

See also:

- *Timeline window—Interrupt Log graph*, page 248
- *Interrupt Log window*, page 243
- *Interrupt Log Summary window*, page 246

## Timeline window—Call Stack graph

The **Timeline** window is available from the *C-SPY driver* menu during a debug session.

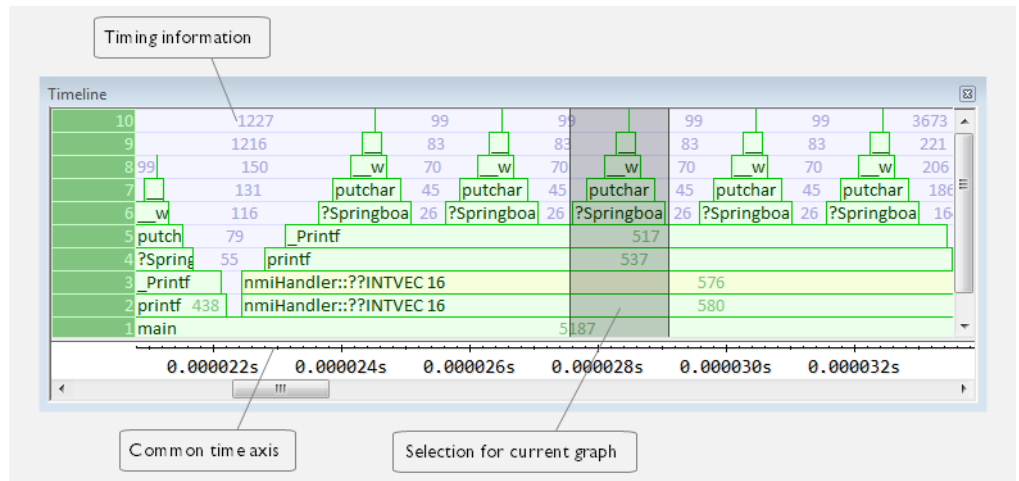

This window displays trace data represented as different graphs, in relation to a shared time axis.

The Call Stack graph displays the sequence of function calls and returns collected by the trace system.

**Note:** There is a limit on the number of saved logs. When this limit is exceeded, the oldest entries in the buffer are erased.

### Requirements

The C-SPY simulator.

### Display area for the Call Stack graph

Each function invocation is displayed as a horizontal bar which extends from the time of entry until the return. Called functions are displayed above its caller. The horizontal bars use four different colors:

- Medium green for normal C functions with debug information
- Light green for functions known to the debugger only through an assembler label
- Medium yellow for normal interrupt handlers, with debug information
- Light yellow for interrupt handlers known to the debugger only through an assembler label

The timing information represents the number of cycles spent in, or between, the function invocations.

At the bottom of the window, there is a shared time axis that uses seconds or cycles as the time unit.

Click in the graph to display the corresponding source code.

### Context menu

This context menu is available:

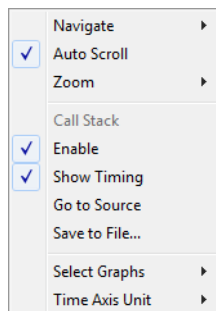

**Note:** The contents of this menu are dynamic and depend on which features that your combination of software and hardware supports. However, the list of menu commands below is complete and covers all possible commands.

These commands are available:

#### Navigate

Commands for navigating the graph(s). Choose between:

**Next** moves the selection to the next relevant point in the graph. Shortcut key: right arrow.

**Previous** moves the selection backward to the previous relevant point in the graph. Shortcut key: left arrow.

**First** moves the selection to the first data entry in the graph. Shortcut key: Home.

**Last** moves the selection to the last data entry in the graph. Shortcut key: End.

**End** moves the selection to the last data in any displayed graph, in other words the end of the time axis. Shortcut key: Ctrl+End.

### Auto Scroll

Toggles automatic scrolling on or off. When on, the most recently collected data is automatically displayed when you choose **Navigate>End**.

### Zoom

Commands for zooming the window, in other words, changing the time scale. Choose between:

**Zoom to Selection** makes the current selection fit the window. Shortcut key: Return.

**Zoom In** zooms in on the time scale. Shortcut key: +.

**Zoom Out** zooms out on the time scale. Shortcut key: -.

**10ns, 100ns, 1us**, etc makes an interval of 10 nanoseconds, 100 nanoseconds, 1 microsecond, respectively, fit the window.

**1ms, 10ms**, etc makes an interval of 1 millisecond or 10 milliseconds, respectively, fit the window.

**10m, 1h**, etc makes an interval of 10 minutes or 1 hour, respectively, fit the window.

### Call Stack

A heading that shows that the Call stack-specific commands below are available.

### Enable

Toggles the display of the graph on or off. If you disable a graph, that graph will be indicated as **OFF** in the window. If no data has been collected for a graph, **no data** will appear instead of the graph.

### Show Timing

Toggles the display of the timing information on or off.

### Go To Source

Displays the corresponding source code in an editor window, if applicable.

**Save to File**

Saves all contents (or the selected contents) of the Call Stack graph to a file. The menu command is only available when C-SPY is not running.

**Select Graphs**

Selects which graphs to be displayed in the **Timeline** window.

**Time Axis Unit**

Selects the unit used in the time axis; choose between **Seconds** and **Cycles**.

If **Cycles** is not available, the graphs are based on different clock sources. In that case you can view cycle values as tooltip information by pointing at the graph with your mouse pointer.

**Profile Selection**

Enables profiling time intervals in the **Function Profiler** window. Note that this command is only available if the C-SPY driver supports PC Sampling.

**Timeline window—Data Log graph**

The **Timeline** window is available from the C-SPY driver menu during a debug session.

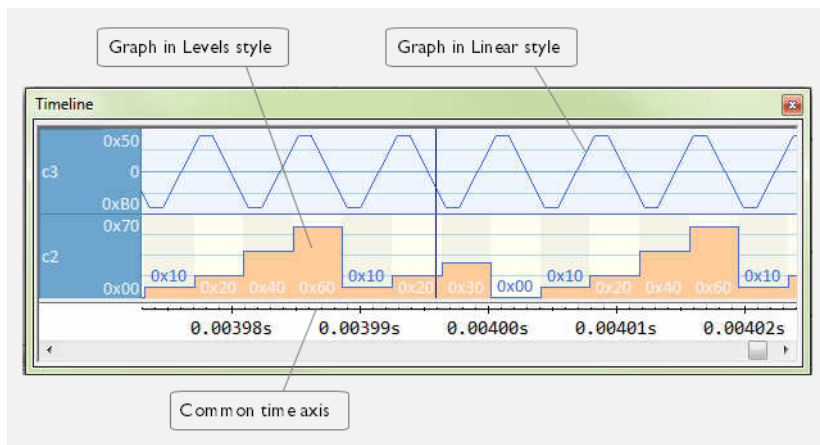

This window displays trace data represented as different graphs, in relation to a shared time axis.



The Data Log graph displays the data logs collected by the trace system, for up to four different variables or address ranges specified as Data Log breakpoints.

**Note:** There is a limit on the number of saved logs. When this limit is exceeded, the oldest entries in the buffer are erased.

## Requirements

The C-SPY simulator.

## Display area for the Data Log graph

Where:

- The label area at the left end of the graph displays the variable name or the address for which you have specified the Data Log breakpoint.
- The graph itself displays how the value of the variable changes over time. The label area also displays the limits, or range, of the Y-axis for a variable. You can use the context menu to change these limits. The graph is a graphical representation of the information in the **Data Log** window, see *Data Log window*, page 196.
- The graph can be displayed either as a thin line between consecutive logs or as a rectangle for every log (optionally color-filled).
- A red vertical line indicates overflow, which means that the communication channel failed to transmit all data logs from the target system. A red question mark indicates a log without a value.

At the bottom of the window, there is a shared time axis that uses seconds or cycles as the time unit.

## Context menu

This context menu is available:

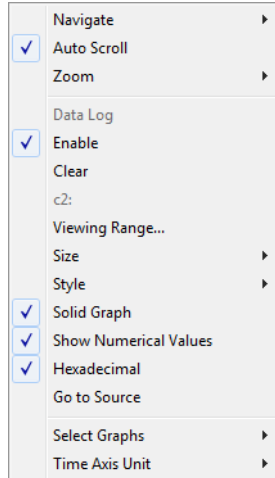

**Note:** The contents of this menu are dynamic and depend on which features that your combination of software and hardware supports. However, the list of menu commands below is complete and covers all possible commands.

These commands are available:

### Navigate

Commands for navigating the graph(s). Choose between:

**Next** moves the selection to the next relevant point in the graph. Shortcut key: right arrow.

**Previous** moves the selection backward to the previous relevant point in the graph. Shortcut key: left arrow.

**First** moves the selection to the first data entry in the graph. Shortcut key: Home.

**Last** moves the selection to the last data entry in the graph. Shortcut key: End.

**End** moves the selection to the last data in any displayed graph, in other words the end of the time axis. Shortcut key: Ctrl+End.

### Auto Scroll

Toggles automatic scrolling on or off. When on, the most recently collected data is automatically displayed when you choose **Navigate>End**.

**Zoom**

Commands for zooming the window, in other words, changing the time scale. Choose between:

**Zoom to Selection** makes the current selection fit the window. Shortcut key: Return.

**Zoom In** zooms in on the time scale. Shortcut key: +

**Zoom Out** zooms out on the time scale. Shortcut key: –

**10ns, 100ns, 1us**, etc makes an interval of 10 nanoseconds, 100 nanoseconds, 1 microsecond, respectively, fit the window.

**1ms, 10ms**, etc makes an interval of 1 millisecond or 10 milliseconds, respectively, fit the window.

**10m, 1h**, etc makes an interval of 10 minutes or 1 hour, respectively, fit the window.

**Data Log**

A heading that shows that the Data Log-specific commands below are available.

**Enable**

Toggles the display of the graph on or off. If you disable a graph, that graph will be indicated as **OFF** in the window. If no data has been collected for a graph, **no data** will appear instead of the graph.

**Clear**

Deletes the log information. Note that this will happen also when you reset the debugger.

**Variable**

The name of the variable for which the Data Log-specific commands below apply. This menu command is context-sensitive, which means it reflects the Data Log graph you selected in the **Timeline** window (one of up to four).

**Viewing Range**

Displays a dialog box, see *Viewing Range dialog box*, page 209.

**Size**

Determines the vertical size of the graph; choose between **Small**, **Medium**, and **Large**.

**Solid Graph**

Displays the graph as a color-filled solid graph instead of as a thin line.

**Show Numerical Value**

Shows the numerical value of the variable, in addition to the graph.

**Hexadecimal**

Toggles between displaying the selected value in decimal or hexadecimal format. Note that this setting also affects the log window.

**Go To Source**

Displays the corresponding source code in an editor window, if applicable.

**Select Graphs**

Selects which graphs to be displayed in the **Timeline** window.

**Time Axis Unit**

Selects the unit used in the time axis; choose between **Seconds** and **Cycles**.

If **Cycles** is not available, the graphs are based on different clock sources. In that case you can view cycle values as tooltip information by pointing at the graph with your mouse pointer.

## Data Log window

The **Data Log** window is available from the C-SPY driver menu.

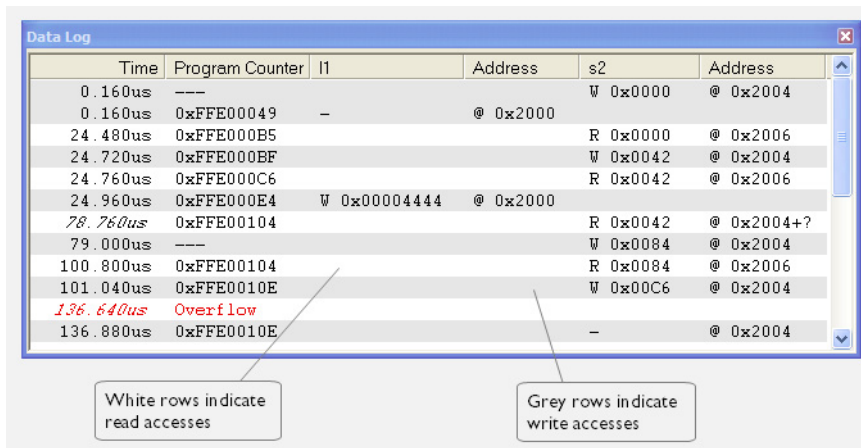

Use this window to log accesses to up to four different memory locations or areas.

**Note:** There is a limit on the number of saved logs. When this limit is exceeded, the oldest entries in the buffer are erased.

See also *Getting started using data logging*, page 187.

## Requirements

The C-SPY simulator.

## Display area

Each row in the display area shows the time, the program counter, and, for every tracked data object, its value and address. All information is cleared on reset. The information is displayed in these columns:

### Time

If the time is displayed in italics, the target system has not been able to collect a correct time, but instead had to approximate it.

This column is available when you have selected **Show time** from the context menu.

### Cycles

The number of cycles from the start of the execution until the event.

If a cycle is displayed in italics, the target system has not been able to collect a correct time, but instead had to approximate it.

This column is available when you have selected **Show cycles** from the context menu.

### Program Counter\*

Displays one of these:

An address, which is the content of the PC, that is, the address of the instruction that performed the memory access.

---, the target system failed to provide the debugger with any information.

**Overflow** in red, the communication channel failed to transmit all data from the target system.

### Value

Displays the access type and the value (using the access size) for the location or area you want to log accesses to. For example, if zero is read using a byte access it will be displayed as 0x00, and for a long access it will be displayed as 0x00000000.

To specify what data you want to log accesses to, use the **Data Log** breakpoint dialog box. See *Data Log breakpoints*, page 103.

### Address

The actual memory address that is accessed. For example, if only a byte of a word is accessed, only the address of the byte is displayed. The address is calculated as base address + offset, where the base address is retrieved from the **Data Log** breakpoint dialog box and the offset is retrieved from the logs. If the log from the target system does not provide the debugger with an offset, the offset contains + ?.

\* You can double-click a line in the display area. If the value of the PC for that line is available in the source code, the editor window displays the corresponding source code (this does not include library source code).

### Context menu

This context menu is available:

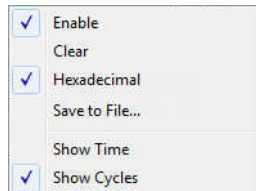

These commands are available:

#### Enable

Enables the logging system. The system will log information also when the window is closed.

#### Clear

Deletes the log information. Note that this will happen also when you reset the debugger.

#### Hexadecimal

Toggles between displaying the selected value in decimal or hexadecimal format. Note that this setting also affects the log window.

#### Save to File

Displays a standard file selection dialog box where you can select the destination file for the log information. The entries in the log file are separated by TAB and LF characters. An X in the **Approx** column indicates that the timestamp is an approximation.

#### Show Time

Displays the **Time** column.

If the **Time** column is displayed by default in the C-SPY driver you are using, this menu command is not available.

### Show Cycles

Displays the **Cycles** column.

If the **Cycles** column is not supported in the C-SPY driver you are using, this menu command is not available.

## Data Log Summary window

The **Data Log Summary** window is available from the C-SPY driver menu.

Data	Total Accesses	Read Accesses	Write Accesses	Unknown Accesses
tVar1	42	0	25	17
tVar2	66	17	49	0
tVar3	32	32	0	0

Approximative time count: 16  
 Overflow count: 8  
 Current time: 4301.52 us

This window displays a summary of data accesses to specific memory location or areas.

See also *Getting started using data logging*, page 187.

### Requirements

The C-SPY simulator.

### Display area

Each row in this area displays the type and the number of accesses to each memory location or area in these columns. Summary information is listed at the bottom of the display area.

#### Data

The name of the data object you have selected to log accesses to. To specify what data object you want to log accesses to, use the **Data Log** breakpoint dialog box. See *Data Log breakpoints*, page 103.

#### Total Accesses

The total number of accesses.

If the sum of read accesses and write accesses is less than the total accesses, the target system for some reason did not provide valid access type information for all accesses.

#### **Read Accesses**

The total number of read accesses.

#### **Write Accesses**

The total number of write accesses.

#### **Unknown Accesses**

The number of unknown accesses, in other words, accesses where the access type is not known.

#### **Approximative time count**

The information displayed depends on the C-SPY driver you are using.

For some C-SPY drivers, this information is not displayed or the value is always zero. In this case, all logs have an exact time stamp.

For other C-SPY drivers, a non-zero value is displayed. The value represents the amount of logs with an approximative time stamp. This might happen if the bandwidth in the communication channel is too low compared to the amount of data packets generated by the CPU or if the CPU generated packets with an approximative time stamp.

#### **Overflow count**

The information displayed depends on the C-SPY driver you are using.

For some C-SPY drivers, this information is not displayed or the value is always zero.

For other C-SPY drivers, the number represents the amount of overflows in the communication channel which can cause logs to be lost. If this happens, it indicates that logs might be incomplete. To solve this, make sure not to use all C-SPY log features simultaneously or check used bandwidth for the communication channel.

#### **Current time|cycles**

The information displayed depends on the C-SPY driver you are using.

For some C-SPY drivers, the value is always zero or not visible at all.

For other C-SPY drivers, the number represents the current time or cycles—the number of cycles or the execution time since the start of execution.



## Context menu

This context menu is available:

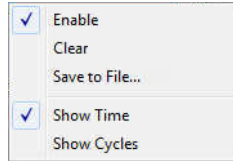

These commands are available:

### Enable

Enables the logging system. The system will log information also when the window is closed.

### Clear

Deletes the log information. Note that this will happen also when you reset the debugger.

### Save to File

Displays a standard file selection dialog box where you can select the destination file for the log information. The entries in the log file are separated by `TAB` and `LF` characters. An **X** in the **Approx** column indicates that the timestamp is an approximation.

### Show Time

Displays the **Time** column.

If the **Time** column is displayed by default in the C-SPY driver you are using, this menu command is not available.

### Show Cycles

Displays the **Cycles** column.

If the **Cycles** column is not supported in the C-SPY driver you are using, this menu command is not available.

## Sampled Graphs window

The **Sampled Graphs** window is available from the C-SPY driver menu.

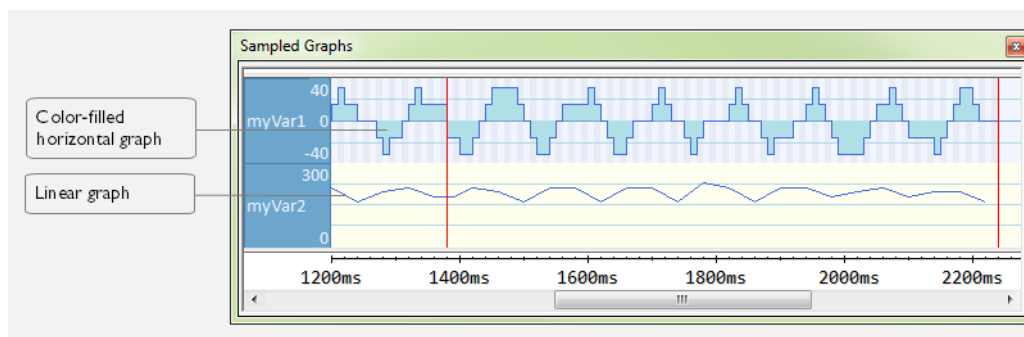

Use this window to display graphs for up to four different variables, and where:

- The graph displays how the value of the variable changes over time. The area on the left displays the limits, or range, of the Y-axis for the variable. You can use the context menu to change these limits. The graph is a graphical representation of the information in the **Data Sample** window, see *Data Sample window*, page 207.
- The graph can be displayed as levels, where a horizontal line—optionally color-filled—shows the value until the next sample. Alternatively, the graph can be linear, where a line connects consecutive samples.
- A red vertical line indicates the time of application execution stops.

At the bottom of the window, there is a shared time axis that uses seconds as the time unit.

To navigate in the graph, use any of these alternatives:

- Right-click and choose **Zoom In** or **Zoom Out** from the context menu. Alternatively, use the + and – keys to zoom.
- Right-click in the graph and choose **Navigate** and the appropriate command to move backward and forward on the graph. Alternatively, use any of the shortcut keys: arrow keys, Home, End, and Ctrl+End.
- Double-click on a sample to highlight the corresponding source code in the editor window and in the **Disassembly** window.
- Click on the graph and drag to select a time interval. Press Enter or right-click and choose **Zoom>Zoom to Selection** from the context menu. The selection zooms in.



Hover with the mouse pointer in the graph to get detailed tooltip information for that location.

See also *Getting started using data sampling*, page 188.

## Requirements

Any supported hardware debugger system.

## Context menu

This context menu is available:

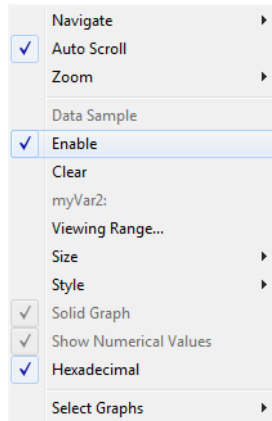

These commands are available:

### Navigate

Commands for navigating in the graphs. Choose between:

**Next** moves the selection to the next relevant point in the graph. Shortcut key: right arrow.

**Previous** moves the selection to the previous relevant point in the graph. Shortcut key: left arrow.

**First** moves the selection to the first data entry in the graph. Shortcut key: Home.

**Last** moves the selection to the last data entry in the graph. Shortcut key: End.

**End** moves the selection to the last data in any displayed graph, in other words the end of the time axis. Shortcut key: Ctrl+End.

### Auto Scroll

Toggles automatic scrolling on or off. When on, the most recently collected data is automatically displayed when you choose **Navigate>End**.

### **Zoom**

Commands for zooming the window, in other words, changing the time scale. Choose between:

**Zoom to Selection** makes the current selection fit the window. Shortcut key: Return.

**Zoom In** zooms in on the time scale. Shortcut key: +.

**Zoom Out** zooms out on the time scale. Shortcut key: -.

**1us, 10us, 100us** makes an interval of 1 microsecond, 10 microseconds, or 100 microseconds, respectively, fit the window.

**1ms, 10ms, 100ms** makes an interval of 1 millisecond, 10 milliseconds, or 100 milliseconds, respectively, fit the window.

**1s, 10s, 100s** makes an interval of 1 second, 10 seconds, or 100 seconds, respectively, fit the window.

**1k s, 10k s, 100k s** makes an interval of 1,000 seconds, 10,000 seconds, or 100,000 seconds, respectively, fit the window.

**1M s, 10M s,** makes an interval of 1,000,000 seconds or 10,000,000 seconds, respectively, fit the window.

### **Data Sample**

A menu item that shows that the Data Sample-specific commands below are available.

#### **Open Setup window (Data Sample Graph)**

Opens the **Data Sample Setup** window.

#### **Enable**

Toggles the display of the graph on or off. If you disable a graph, that graph will be indicated as **OFF** in the window. If no data has been collected for a graph, **no data** will appear instead of the graph.

#### **Clear**

Clears the sampled data.

#### **Variable**

The name of the variable for which the Data Sample-specific commands below apply. This menu item is context-sensitive, which means it reflects the Data Sample graph you selected in the **Sampled Graphs** window (one of up to four).

#### **Viewing Range**

Displays a dialog box, see *Viewing Range dialog box*, page 209.

**Size**

Controls the vertical size of the graph; choose between **Small**, **Medium**, and **Large**.

**Style**

Choose how to display the graph. Choose between:

**Levels**, where a horizontal line—optionally color-filled—shows the value until the next sample.

**Linear**, where a line connects consecutive samples.

**Solid Graph**

Displays the graph as a color-filled solid graph instead of as a thin line. This is only possible if the graph is displayed as Levels.

**Hexadecimal**

Toggles between displaying the selected value in decimal or hexadecimal format. Note that this setting also affects the log window.

**Show Numerical Value**

Shows the numerical value of the variable, in addition to the graph.

**Select Graphs**

Selects which graphs to display in the **Sampled Graphs** window.

## Data Sample Setup window

The **Data Sample Setup** window is available from the C-SPY driver menu.

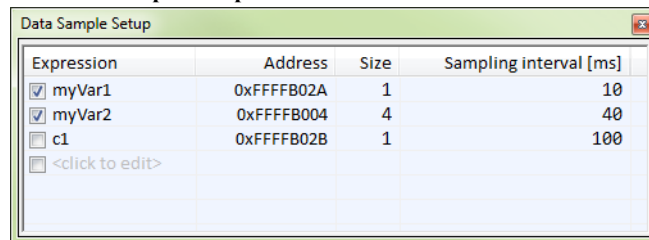

Expression	Address	Size	Sampling interval [ms]
<input checked="" type="checkbox"/> myVar1	0xFFFFB02A	1	10
<input checked="" type="checkbox"/> myVar2	0xFFFFB004	4	40
<input type="checkbox"/> c1	0xFFFFB02B	1	100
<input type="checkbox"/> <click to edit>			

Use this window to specify up to four variables to sample data for. You can view the sampled data for the variables either in the **Data Sample** window or as graphs in the **Sampled Graphs** window.

See also *Getting started using data sampling*, page 188.

## Requirements

Any supported hardware debugger system.

## Display area

This area contains these columns:

### Expression

Type the name of the variable which must be an integral type with a maximum size of 32 bits. Click the check box to enable or disable data sampling for the variable.

Alternatively, drag an expression from the editor window and drop it in the display area.

Variables in the expressions must be statically located, for example global variables.

### Address

The actual memory address that is accessed. The column cells cannot be edited.

### Size

The size of the variable, either 1, 2, or 4 bytes. The column cells cannot be edited.

### Sampling interval [ms]

Type the number of milliseconds to pass between the samples. The shortest allowed interval is 10 ms and the interval you specify must be a multiple of that.

Note that the sampling time you specify is just the interval (according to the Microsoft Windows calculations) for how often C-SPY checks with the C-SPY driver (which in turn must check with the MCU for a value). If this takes longer than the sampling interval you have specified, the next sampling will be omitted. If this occurs, you might want to consider increasing the sampling time.

## Context menu

This context menu is available:

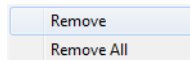

These commands are available:

### Remove

Removes the selected variable.

**Remove All**

Removes all variables.

**Data Sample window**

The **Data Sample** window is available from the C-SPY driver menu.

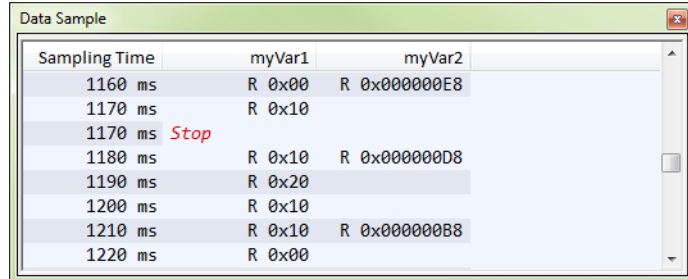

Sampling Time	myVar1	myVar2
1160 ms	R 0x00	R 0x000000E8
1170 ms	R 0x10	
1170 ms <i>Stop</i>		
1180 ms	R 0x10	R 0x000000D8
1190 ms	R 0x20	
1200 ms	R 0x10	
1210 ms	R 0x10	R 0x000000B8
1220 ms	R 0x00	

Use this window to view the result of the data sampling for the variables you have selected in the **Data Sample Setup** window.

Choose **Enable** from the context menu to enable data sampling.

See also *Getting started using data sampling*, page 188.

**Requirements**

Any supported hardware debugger system.

**Display area**

This area contains these columns:

**Sampling Time**

The time when the data sample was collected. Time starts at zero after a reset. Every time the execution stops, a red `Stop` indicates when the stop occurred.

**The selected expression**

The column headers display the names of the variables that you selected in the **Data Sample Setup** window. The column cells display the sampling values for the variable.

There can be up to four columns of this type, one for each selected variable.

\* You can double-click a row in the display area. If you have enabled the data sample graph in the **Sampled Graphs** window, the selection line will be moved to reflect the time of the row you double-clicked.

## Context menu

This context menu is available:

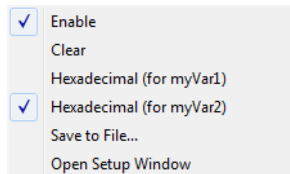

These commands are available:

### **Enable**

Enables data sampling.

### **Clear**

Clears the sampled data.

### **Hexadecimal**

Toggles between displaying the selected value in decimal or hexadecimal format. Note that this setting also affects the log window.

### **Save to File**

Displays a standard file selection dialog box where you can select the destination file for the log information. The entries in the log file are separated by `TAB` and `LF` characters. An **X** in the **Approx** column indicates that the timestamp is an approximation.

### **Open setup window**

Opens the **Data Sample Setup** window.



## Viewing Range dialog box

The **Viewing Range** dialog box is available from the context menu that appears when you right-click in any graph in the **Timeline** window that uses the linear, levels or columns style.

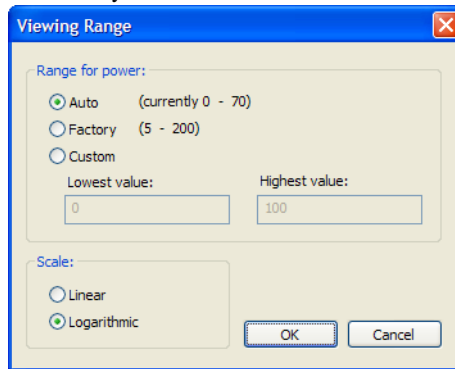

Use this dialog box to specify the value range, that is, the range for the Y-axis for the graph.

### Requirements

The C-SPY simulator.

### Range for ...

Selects the viewing range for the displayed values:

#### Auto

Uses the range according to the range of the values that are actually collected, continuously keeping track of minimum or maximum values. The currently computed range, if any, is displayed in parentheses. The range is rounded to reasonably *even* limits.

#### Factory

For the Power Log graph: Uses the range according to the properties of the measuring hardware (only if supported by the product edition you are using).

For the other graphs: Uses the range according to the value range of the variable, for example 0–65535 for an unsigned 16-bit integer.

#### Custom

Use the text boxes to specify an explicit range.

## Scale

Selects the scale type of the Y-axis:

- **Linear**
- **Logarithmic.**

# Profiling

- Introduction to the profiler
- Using the profiler
- Reference information on the profiler

---

## Introduction to the profiler

These topics are covered:

- Reasons for using the profiler
- Briefly about the profiler
- Requirements for using the profiler

### REASONS FOR USING THE PROFILER

*Function profiling* can help you find the functions in your source code where the most time is spent during execution. You should focus on those functions when optimizing your code. A simple method of optimizing a function is to compile it using speed optimization. Alternatively, you can move the data used by the function into more efficient memory. For detailed information about efficient memory usage, see the *IAR C/C++ Development Guide for STM8*.

Alternatively, you can use *filtered profiling*, which means that you can exclude, for example, individual functions from being profiled. To profile only a specific part of your code, you can select a *time interval*—using the **Timeline** window—for which C-SPY produces profiling information.

*Instruction profiling* can help you fine-tune your code on a very detailed level, especially for assembler source code. Instruction profiling can also help you to understand where your compiled C/C++ source code spends most of its time, and perhaps give insight into how to rewrite it for better performance.

### BRIEFLY ABOUT THE PROFILER

*Function profiling* information is displayed in the **Function Profiler** window, that is, timing information for the functions in an application. Profiling must be turned on explicitly using a button on the window's toolbar, and will stay enabled until it is turned off.

*Instruction profiling* information is displayed in the **Disassembly** window, that is, the number of times each instruction has been executed.

### Profiling sources

The profiler can use different mechanisms, or *sources*, to collect profiling information. Depending on the available trace source features, one or more of the sources can be used for profiling:

- Trace (calls)
 

The full instruction trace is analyzed to determine all function calls and returns. When the collected instruction sequence is incomplete or discontinuous, the profiling information is less accurate.
- Trace (flat)
 

Each instruction in the full instruction trace or each PC Sample is assigned to a corresponding function or code fragment, without regard to function calls or returns. This is most useful when the application does not exhibit normal call/return sequences, such as when you are using an RTOS, or when you are profiling code which does not have full debug information.

### REQUIREMENTS FOR USING THE PROFILER

The C-SPY simulator support the profiler; there are no specific requirements.

To use the profiler in your hardware debugger system, you need:

- A device that is supported by STIce
- To enable the options **Instruction**, **Discarded**, and **Interrupted** in the **Trace Settings** dialog box. For more information, see *Trace Settings dialog box*, page 168.

This table lists the C-SPY driver profiling support:

C-SPY driver	Trace (calls)	Trace (flat)
C-SPY simulator	Yes	Yes
C-SPY STIce driver	Yes	Yes

*Table 9: C-SPY driver profiling support*

STIce uses trace for function profiling and built-in STIce features for instruction profiling.

#### Note:

- Instruction profiling cannot be used at the same time as trace or data coverage.
- Function profiling cannot be used at the same time as code coverage, data coverage, or instruction profiling.

## Using the profiler

These tasks are covered:

- Getting started using the profiler on function level
- Analyzing the profiling data
- Getting started using the profiler on instruction level

### GETTING STARTED USING THE PROFILER ON FUNCTION LEVEL

To display function profiling information in the **Function Profiler** window:

- I Build your application using these options:

Category	Setting
C/C++ Compiler	Output>Generate debug information
Linker	Output>Include debug information in output

Table 10: Project options for enabling the profiler



- 2 When you have built your application and started C-SPY, choose **C-SPY driver>Function Profiler** to open the **Function Profiler** window, and click the **Enable** button to turn on the profiler. Alternatively, choose **Enable** from the context menu that is available when you right-click in the **Function Profiler** window.
- 3 Start executing your application to collect the profiling information.
- 4 Profiling information is displayed in the **Function Profiler** window. To sort, click on the relevant column header.
- 5 When you start a new sampling, you can click the **Clear** button—alternatively, use the context menu—to clear the data.



### ANALYZING THE PROFILING DATA

Here follow some examples of how to analyze the data.

The first figure shows the result of profiling using **Source: Trace (calls)**. The profiler follows the program flow and detects function entries and exits.

- For the **InitFib** function, **Flat Time** 231 is the time spent inside the function itself.
- For the **InitFib** function, **Acc Time** 487 is the time spent inside the function itself, including all functions **InitFib** calls.
- For the **InitFib/GetFib** function, **Acc Time** 256 is the time spent inside **GetFib** (but only when called from **InitFib**), including any functions **GetFib** calls.

- Further down in the data, you can find the **GetFib** function separately and see all of its subfunctions (in this case none).

The screenshot shows the 'Function Profiler' window with a table of function calls. The table has columns for Function, Calls, Flat Time, Flat Time (%), Acc. Time, and Acc. Time (%). The 'GetFib' function is highlighted in blue, and a context menu is open over it. The menu options are: Enable (checked), Clear, Source: Trace (calls) (checked), and Source: Trace (flat). Red circles highlight the '231' value in the Flat Time column for the first 'GetFib' entry and the '487' value in the Acc. Time column for the same entry.

Function	Calls	Flat Time	Flat Time (%)	Acc. Time	Acc. Time (%)
main	1	165	3.58	4356	94.39
DoForegroundProcess	10			3704	
InitFib	1			487	
PutFib	10	3174	68.78	3174	68.78
NextCounter	10	100	2.17	100	2.17
InitFib	1	231	5.01	487	10.55
GetFib	16			256	
GetFib	26	416	9.01	416	9.01
DoForegroundProcess	10	270	5.85	3704	80.26
GetFib	10			160	
NextCounter	10				
PutFib	10				
<Other>	0	25			98.85
main	1				

The second figure shows the result of profiling using **Source: Trace (flat)**. In this case, the profiler does not follow the program flow, instead the profiler only detects whether the PC address is within the function scope. For incomplete trace data, the data might contain minor errors.

For the **InitFib** function, **Flat Time** 231 is the time (number of hits) spent inside the function itself.

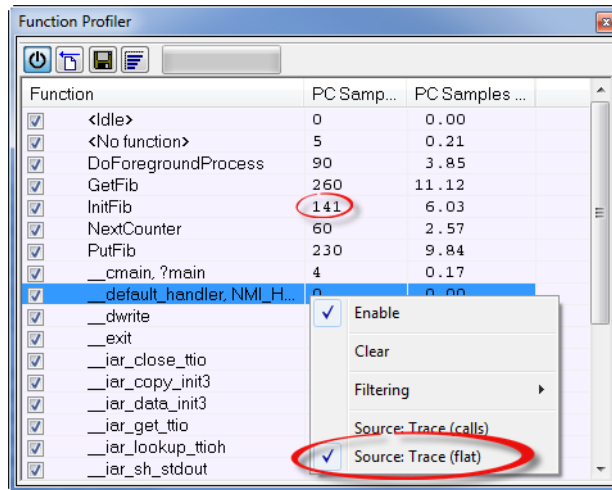

To secure valid data when using a debug probe, make sure to use the maximum trace buffer size and set a breakpoint in your code to stop the execution before the buffer is full.

## GETTING STARTED USING THE PROFILER ON INSTRUCTION LEVEL

**To display instruction profiling information in the Disassembly window:**

- 1 When you have built your application and started C-SPY, choose **View>Disassembly** to open the **Disassembly** window, and choose **Instruction Profiling>Enable** from the context menu that is available when you right-click in the left-hand margin of the **Disassembly** window.
- 2 Make sure that the **Show** command on the context menu is selected, to display the profiling information.
- 3 Start executing your application to collect the profiling information.
- 4 When the execution stops, for instance because the program exit is reached or a breakpoint is triggered, you can view instruction level profiling information in the left-hand margin of the window.

The screenshot shows a disassembly window with the following assembly code and execution counts:

```

Dly100us:
text_12:
0 08005F92 B082 SUB SP, SP, #0x8
Int32U Dly = (Int32U)arg;
0 08005F94 E005 B ??Dly100us_0
for(volatile int i = LOOP_DLY_100US; i; i--):
??Dly100us_1:
34 08005F96 9900 LDR R1, [SP]
5 08005F98 1E49 SUBS R1, R1, #0x1
5 08005F9A 9100 STR R1, [SP]
for(volatile int i = LOOP_DLY_100US; i; i--):
??Dly100us_2:
11 08005F9C 9900 LDR R1, [SP]
3 08005F9E 2900 CMP R1, #0x0
34 08005FA0 D1F9 BNE ??Dly100us_1
while(Dly--)
??Dly100us_0:
0 08005FA2 0001 MOVS R1, R0
0 08005FA4 1E48 SUBS R0, R1, #0x1

```

For each instruction, the number of times it has been executed is displayed.

## Reference information on the profiler

Reference information about:

- *Function Profiler window*, page 216

See also:

- *Disassembly window*, page 63
- *Trace Settings dialog box*, page 168

## Function Profiler window

The **Function Profiler** window is available from the C-SPY driver menu.

Function	Calls	Flat Time	Flat Time (%)	Acc. Time	Acc. Time (%)
main()	1	165	3.57	4356	94.18
PutFib(unsigned int)	10	3174	68.63	3174	68.63
NextCounter()	10	100	2.16	100	2.16
InitFib()	1	231	4.99	487	10.53
GetFib(int)	26	416	8.99	416	8.99
DoForegroundProcess()	10	270	5.84	3704	80.09
<Other>	0	269	5.82	4572	98.85

This window displays function profiling information.



When Trace(flat) is selected, a checkbox appears on each line in the left-side margin of the window. Use these checkboxes to include or exclude lines from the profiling. Excluded lines are dimmed but not removed.

See also *Using the profiler*, page 213.

## Requirements

One of these alternatives:

- The C-SPY Simulator
- An STice emulator. Make sure to use the C-SPY driver for STice, but not with the SWIM interface.

## Toolbar

The toolbar contains:



### Enable/Disable

Enables or disables the profiler.



### Clear

Clears all profiling data.



### Save

Opens a standard **Save As** dialog box where you can save the contents of the window to a file, with tab-separated columns. Only non-expanded rows are included in the list file.



### Graphical view

Overlays the values in the percentage columns with a graphical bar.

### *Progress bar*

Displays a backlog of profiling data that is still being processed. If the rate of incoming data is higher than the rate of the profiler processing the data, a backlog is accumulated. The progress bar indicates that the profiler is still processing data, but also approximately how far the profiler has come in the process. Note that because the profiler consumes data at a certain rate and the target system supplies data at another rate, the amount of data remaining to be processed can both increase and decrease. The progress bar can grow and shrink accordingly.

## Display area

The content in the display area depends on which source that is used for the profiling information:

- For the Trace (calls) source, the display area contains one line for each function compiled with debug information enabled. When some profiling information has been collected, it is possible to expand rows of functions that have called other functions. The child items for a given function list all the functions that have been called by the parent function and the corresponding statistics.
- For the Trace (flat) source, the display area contains one line for each C function of your application, but also lines for sections of code from the runtime library or from other code without debug information, denoted only by the corresponding assembler labels. Each executed PC address from trace data is treated as a separate sample and is associated with the corresponding line in the Profiling window. Each line contains a count of those samples.

For information about which views that are supported in the C-SPY driver you are using, see *Requirements for using the profiler*, page 212.

More specifically, the display area provides information in these columns:

### **Function (All sources)**

The name of the profiled C function.

### **Calls (Trace (calls))**

The number of times the function has been called.

### **Flat time (Trace (calls))**

The time expressed in cycles spent inside the function.

### **Flat time (%) (Trace (calls))**

Flat time expressed as a percentage of the total time.

### **Acc. time (Trace (calls))**

The time expressed in cycles spent inside the function and everything called by the function.

### **Acc. time (%) (Trace (calls))**

Accumulated time expressed as a percentage of the total time.

### **PC Samples (Trace (flat))**

The number of PC samples associated with the function.

### **PC Samples (%) (Trace (flat))**

The number of PC samples associated with the function as a percentage of the total number of samples.

## Context menu

This context menu is available:

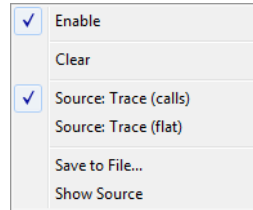

The contents of this menu depend on the C-SPY driver you are using.

These commands are available:

### Enable

Enables the profiler. The system will collect information also when the window is closed.

### Clear

Clears all profiling data.

### Filtering

Selects which part of your code to profile. Choose between:

**Check All**—Excludes all lines from the profiling.

**Uncheck All**—Includes all lines in the profiling.

**Load**—Reads all excluded lines from a saved file.

**Save**—Saves all excluded lines to a file. Typically, this can be useful if you are a group of engineers and want to share sets of exclusions.

These commands are only available when using Trace (flat).

### Source\*

Selects which source to be used for the profiling information. See also *Profiling sources*, page 212. Choose between:

**Trace (calls)**—the instruction count for instruction profiling is only as complete as the collected trace data.

**Trace (flat)**—the instruction count for instruction profiling is only as complete as the collected trace data.

### Save to File

Saves all profiling data to a file.

**Show Source**

Opens the editor window (if not already opened) and highlights the selected source line.

\* The available sources depend on the C-SPY driver you are using.

# Code coverage

- Introduction to code coverage
- Reference information on code coverage.

---

## Introduction to code coverage

These topics are covered:

- Reasons for using code coverage
- Briefly about code coverage
- Requirements and restrictions for using code coverage.

### REASONS FOR USING CODE COVERAGE

The code coverage functionality is useful when you design your test procedure to verify whether all parts of the code have been executed. It also helps you identify parts of your code that are not reachable.

### BRIEFLY ABOUT CODE COVERAGE

The **Code Coverage** window reports the status of the current code coverage analysis for C code. For every program, module, and function, the analysis shows the percentage of code that has been executed since code coverage was turned on up to the point where the application has stopped. In addition, all statements that have not been executed are listed. The analysis will continue until turned off.

**Note:** Assembler code is not covered by the code coverage analysis. To view assembler code, use the **Disassembly** window.

### REQUIREMENTS AND RESTRICTIONS FOR USING CODE COVERAGE

Code coverage is supported by the C-SPY Simulator and there are no specific requirements or restrictions.

To use code coverage in your hardware debugger system, you need the C-SPY STice driver, not using the SWIM interface.

## Reference information on code coverage

Reference information about:

- *Code Coverage window*, page 222.

See also *Single stepping*, page 56.

## Code Coverage window

The **Code Coverage** window is available from the **View** menu.

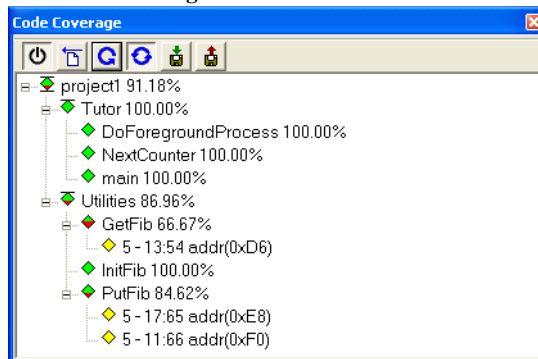

This window reports the status of the current code coverage analysis. For every program, module, and function, the analysis shows the percentage of code that has been executed since code coverage was turned on up to the point where the application has stopped. In addition, all statements that have not been executed are listed. The analysis will continue until turned off.

An asterisk (\*) in the title bar indicates that C-SPY has continued to execute, and that the **Code Coverage** window must be refreshed because the displayed information is no longer up to date. To update the information, use the **Refresh** button.

### To get started using code coverage:

- Before using the code coverage functionality you must build your application using these options:

Category	Setting
C/C++ Compiler	Output>Generate debug information
Linker	Output>Include debug information in output
Debugger	Plugins>Code Coverage

Table 11: Project options for enabling code coverage

2 After you have built your application and started C-SPY, choose **View>Code Coverage** to open the **Code Coverage** window.



3 Click the **Activate** button, alternatively choose **Activate** from the context menu, to switch on code coverage.



4 Start the execution. When the execution stops, for instance because the program exit is reached or a breakpoint is triggered, click the **Refresh** button to view the code coverage information.

## Requirements

One of these alternatives:

- The C-SPY Simulator
- The C-SPY STice driver, not using the SWIM interface.

## Display area

The code coverage information is displayed in a tree structure, showing the program, module, function, and statement levels. The window displays only source code that was compiled with debug information. Thus, startup code, exit code, and library code is not displayed in the window. Furthermore, coverage information for statements in inlined functions is not displayed. Only the statement containing the inlined function call is marked as executed. The plus sign and minus sign icons allow you to expand and collapse the structure.

These icons give you an overview of the current status on all levels:

Red diamond	Signifies that 0% of the modules or functions has been executed.
Green diamond	Signifies that 100% of the modules or functions has been executed.
Red and green diamond	Signifies that some of the modules or functions have been executed.
Yellow diamond	Signifies a statement that has not been executed.

The percentage displayed at the end of every program, module, and function line shows the amount of statements that has been covered so far, that is, the number of executed statements divided with the total number of statements.

For statements that have not been executed (yellow diamond), the information displayed is the column number range and the row number of the statement in the source window, followed by the address of the step point:

```
<column_start>-<column_end>: row address.
```

A statement is considered to be executed when one of its instructions has been executed. When a statement has been executed, it is removed from the window and the percentage is increased correspondingly.

Double-clicking a statement or a function in the **Code Coverage** window displays that statement or function as the current position in the editor window, which becomes the active window. Double-clicking a module on the program level expands or collapses the tree structure.

### Context menu

This context menu is available:

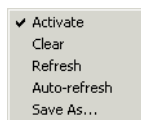

These commands are available:



#### Activate

Switches code coverage on and off during execution.



#### Clear

Clears the code coverage information. All step points are marked as not executed.



#### Refresh

Updates the code coverage information and refreshes the window. All step points that have been executed since the last refresh are removed from the tree.



#### Auto-refresh

Toggles the automatic reload of code coverage information on and off. When turned on, the code coverage information is reloaded automatically when C-SPY stops at a breakpoint, at a step point, and at program exit.

#### Save As

Saves the current code coverage result in a text file.



#### Save session

Saves your code coverage session data to a \*.dat file. This is useful if you for some reason must abort your debug session, but want to continue the session later on. This command is available on the toolbar. This command might not be supported by the C-SPY driver you are using.



**Restore session**

Restores previously saved code coverage session data. This is useful if you for some reason must abort your debug session, but want to continue the session later on. This command is available on the toolbar. This command might not be supported by the C-SPY driver you are using.



# Part 3. Advanced debugging

This part of the *C-SPY® Debugging Guide for STM8* includes these chapters:

- Interrupts
- C-SPY macros
- The C-SPY command line utility—`cspybat`

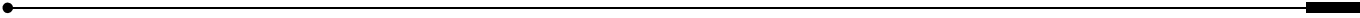
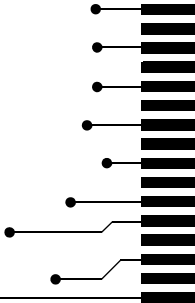

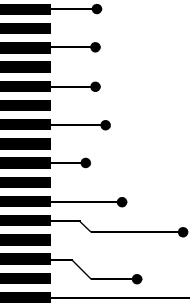

# Interrupts

- Introduction to interrupts
- Using the interrupt system
- Reference information on interrupts

---

## Introduction to interrupts

These topics are covered:

- Briefly about the interrupt simulation system
- Interrupt characteristics
- Interrupt simulation states
- C-SPY system macros for interrupt simulation
- Target-adapting the interrupt simulation system
- Briefly about interrupt logging

See also:

- *Reference information on C-SPY system macros*, page 267
- *Breakpoints*, page 101
- *The IAR C/C++ Development Guide for STM8*

### **BRIEFLY ABOUT THE INTERRUPT SIMULATION SYSTEM**

By simulating interrupts, you can test the logic of your interrupt service routines and debug the interrupt handling in the target system long before any hardware is available. If you use simulated interrupts in conjunction with C-SPY macros and breakpoints, you can compose a complex simulation of, for instance, interrupt-driven peripheral devices.

The C-SPY Simulator includes an interrupt simulation system where you can simulate the execution of interrupts during debugging. You can configure the interrupt simulation system so that it resembles your hardware interrupt system.

The interrupt system has the following features:

- Simulated interrupt support for the STM8 microcontroller
- Single-occasion or periodical interrupts based on the cycle counter
- Predefined interrupts for various devices

- Configuration of hold time, probability, and timing variation
- State information for locating timing problems
- Configuration of interrupts using a dialog box or a C-SPY system macro—that is, one interactive and one automating interface. In addition, you can instantly force an interrupt.
- A log window that continuously displays events for each defined interrupt.
- A status window that shows the current interrupt activities.

All interrupts you define using the **Interrupt Configuration** window are preserved between debug sessions, unless you remove them. A forced interrupt, on the other hand, exists only until it has been serviced and is not preserved between sessions.



The interrupt simulation system is activated by default, but if not required, you can turn off the interrupt simulation system to speed up the simulation. To turn it off, use either the **Interrupt Configuration** window or a system macro.

## INTERRUPT CHARACTERISTICS

The simulated interrupts consist of a set of characteristics which lets you fine-tune each interrupt to make it resemble the real interrupt on your target hardware. You can specify a *first activation time*, a *repeat interval*, a *hold time*, a *variance*, and a *probability*.

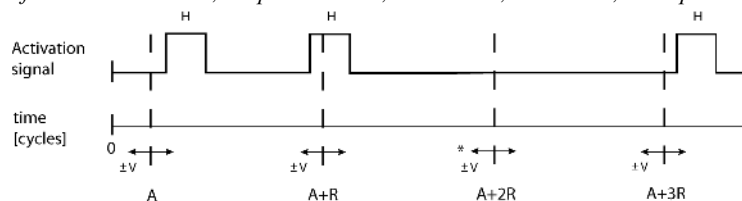

\* If probability is less than 100%, some interrupts may be omitted.

A = Activation time  
R = Repeat interval  
H = Hold time  
V = Variance

The interrupt simulation system uses the cycle counter as a clock to determine when an interrupt should be raised in the simulator. You specify the *first activation time*, which is based on the cycle counter. C-SPY will generate an interrupt when the cycle counter has passed the specified activation time. However, interrupts can only be raised between instructions, which means that a full assembler instruction must have been executed before the interrupt is generated, regardless of how many cycles an instruction takes.

To define the periodicity of the interrupt generation you can specify the *repeat interval* which defines the amount of cycles after which a new interrupt should be generated. In addition to the repeat interval, the periodicity depends on the two options *probability*—

the probability, in percent, that the interrupt will actually appear in a period—and *variance*—a time variation range as a percentage of the repeat interval. These options make it possible to randomize the interrupt simulation. You can also specify a *hold time* which describes how long the interrupt remains pending until removed if it has not been processed. If the hold time is set to *infinite*, the corresponding pending bit will be set until the interrupt is acknowledged or removed.

## INTERRUPT SIMULATION STATES

The interrupt simulation system contains status information that you can use for locating timing problems in your application. The **Interrupt Status** window displays the available status information. For an interrupt, these states can be displayed: *Idle*, *Pending*, *Executing*, or *Suspended*.

Normally, a repeatable interrupt has a specified repeat interval that is longer than the execution time. In this case, the status information at different times looks like this:

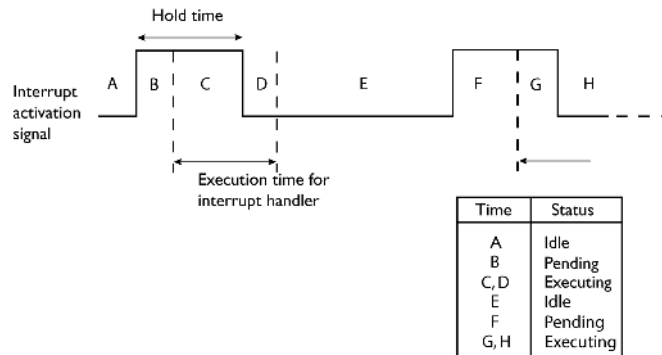

**Note:** The interrupt activation signal—also known as the pending bit—is automatically deactivated the moment the interrupt is acknowledged by the interrupt handler.

However, if the interrupt repeat interval is shorter than the execution time, and the interrupt is reentrant (or non-maskable), the status information at different times looks like this:

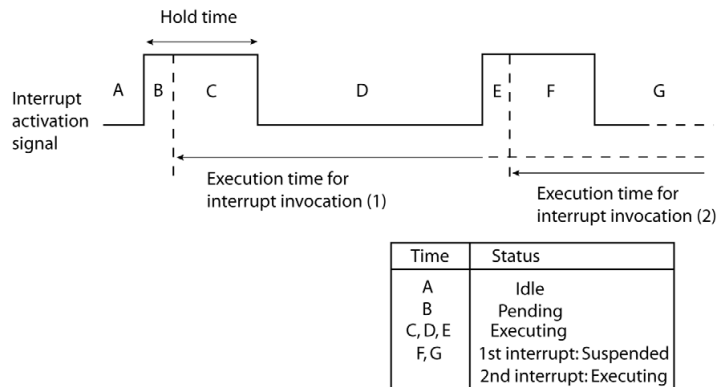

An execution time that is longer than the repeat interval might indicate that you should rewrite your interrupt handler and make it faster, or that you should specify a longer repeat interval for the interrupt simulation system.

## C-SPY SYSTEM MACROS FOR INTERRUPT SIMULATION

Macros are useful when you already have sorted out the details of the simulated interrupt so that it fully meets your requirements. If you write a macro function containing definitions for the simulated interrupts, you can execute the functions automatically when C-SPY starts. Another advantage is that your simulated interrupt definitions will be documented if you use macro files, and if you are several engineers involved in the development project you can share the macro files within the group.

The C-SPY Simulator provides these predefined system macros related to interrupts:

```
__enableInterrupts
__disableInterrupts
__orderInterrupt
__cancelInterrupt
__cancelAllInterrupts
__popSimulatorInterruptExecutingStack
```

The parameters of the first five macros correspond to the equivalent entries of the **Interrupt Configuration** window.



For more information about each macro, see *Reference information on C-SPY system macros*, page 267.

## TARGET-ADAPTING THE INTERRUPT SIMULATION SYSTEM

The interrupt simulation system is easy to use. However, to take full advantage of the interrupt simulation system you should be familiar with how to adapt it for the processor you are using.

The interrupt simulation has the same behavior as the hardware. This means that the execution of an interrupt is dependent on the status of the global interrupt enable bit. The execution of maskable interrupts is also dependent on the status of the individual interrupt enable bits.

To simulate device-specific interrupts, the interrupt system must have detailed information about each available interrupt. This information is provided in the device description files.

For information about device description files, see *Selecting a device description file*, page 38.

## BRIEFLY ABOUT INTERRUPT LOGGING

Interrupt logging provides you with comprehensive information about the interrupt events. This might be useful for example, to help you locate which interrupts you can fine-tune to become faster. You can log entrances and exits to and from interrupts. You can also log internal interrupt status information, such as triggered, expired, etc. In the IDE:

- The logs are displayed in the **Interrupt Log** window
- A summary is available in the **Interrupt Log Summary** window
- The Interrupt graph in the **Timeline** window provides a graphical view of the interrupt events during the execution of your application.

### Requirements for interrupt logging

Interrupt logging is supported by the C-SPY simulator.

See also *Getting started using interrupt logging*, page 236.

---

## Using the interrupt system

These tasks are covered:

- Simulating a simple interrupt
- Simulating an interrupt in a multi-task system

- Getting started using interrupt logging.

See also:

- *Using C-SPY macros*, page 255 for details about how to use a setup file to define simulated interrupts at C-SPY startup
- The tutorial *Simulating an interrupt* in the Information Center.

## SIMULATING A SIMPLE INTERRUPT

This example demonstrates the method for simulating a timer interrupt. However, the procedure can also be used for other types of interrupts.

### To simulate and debug an interrupt:

- 1 Assume this example application which contains an interrupt service routine for a timer, which increments a tick variable. The main function sets the necessary status registers. The application exits when 100 interrupts have been generated.

```
#pragma language = extended
#include "iostm8.h"
#include <intrinsics.h>

volatile int ticks = 0;
void main (void)
{
    /* Add your timer setup code here */

    __enable_interrupt();          /* Enable interrupts */

    while (ticks < 100);          /* Endless loop */
    printf("Done\n");
}

/* Timer interrupt service routine */
#pragma vector = TIMER_VECTOR
__interrupt void basic_timer(void)
{
    ticks += 1;
}
```

- 2 Add your interrupt service routine to your application source code and add the file to your project.
- 3 Build your project and start the simulator.

- 4 Choose **Simulator>Interrupt Configuration** to open the **Interrupt Configuration** dialog box. Right-click in the window and select **Enable Interrupt Simulation** on the context menu. For the timer example, verify these settings:

Option	Settings
Interrupt	TIMER_VECTOR
First activation	4000
Repeat interval	2000
Hold time	10
Probability (%)	100
Variance (%)	0

Table 12: Timer interrupt settings

Click **OK**.

- 5 Execute your application. If you have enabled the interrupt properly in your application source code, C-SPY will:
- Generate an interrupt when the cycle counter has passed 4000
  - Continuously repeat the interrupt after approximately 2000 cycles.
- 6 To watch the interrupt in action, choose **Simulator>Interrupt Log** to open the **Interrupt Log** window.
- 7 From the context menu, available in the **Interrupt Log** window, choose **Enable** to enable the logging. If you restart program execution, status information about entrances and exits to and from interrupts will now appear in the **Interrupt Log** window.

For information about how to get a graphical representation of the interrupts correlated with a time axis, see *Reference information on application timeline*, page 188.

## SIMULATING AN INTERRUPT IN A MULTI-TASK SYSTEM

If you are using interrupts in such a way that the normal instruction used for returning from an interrupt handler is not used, for example in an operating system with task-switching, the simulator cannot automatically detect that the interrupt has finished executing. The interrupt simulation system will work correctly, but the status information in the **Interrupt Configuration** window might not look as you expect. If too many interrupts are executing simultaneously, a warning might be issued.

### To simulate a normal interrupt exit:

- I Set a code breakpoint on the instruction that returns from the interrupt function.

- 2 Specify the `__popSimulatorInterruptExecutingStack` macro as a condition to the breakpoint.

When the breakpoint is triggered, the macro is executed and then the application continues to execute automatically.

## GETTING STARTED USING INTERRUPT LOGGING

- 1 Choose *C-SPY driver*>**Interrupt Log** to open the **Interrupt Log** window. Optionally, you can also choose:
  - *C-SPY driver*>**Interrupt Log Summary** to open the **Interrupt Log Summary** window
  - *C-SPY driver*>**Timeline** to open the **Timeline** window and view the Interrupt graph.
- 2 From the context menu in the **Interrupt Log** window, choose **Enable** to enable the logging.
- 3 Start executing your application program to collect the log information.
- 4 To view the interrupt log information, look in the **Interrupt Log** or **Interrupt Log Summary** window, or at the Interrupt graph in the **Timeline** window.
- 5 If you want to save the log or summary to a file, choose **Save to log file** from the context menu in the window in question.
- 6 To disable interrupt logging, from the context menu in the **Interrupt Log** window, toggle **Enable** off.

---

## Reference information on interrupts

Reference information about:

- *Interrupt Configuration window*, page 237
- *Available Interrupts window*, page 240
- *Interrupt Status window*, page 241
- *Interrupt Log window*, page 243
- *Interrupt Log Summary window*, page 246.
- *Timeline window—Interrupt Log graph*, page 248.

## Interrupt Configuration window

The **Interrupt Configuration** window is available by choosing **Simulator>Interrupt Configuration**.

Interrupt	Id	Type	Description	First Activation	Repeat Interval	Hold Time	Variance (%)	Probability (%)
<input checked="" type="checkbox"/> NMI	0	Single	-2 0x08	0	0	inf	0	100
<input checked="" type="checkbox"/> IEL0	1	Single	1 0x40	0	0	inf	0	100
<input checked="" type="checkbox"/> HardFault	2	Single	-1 0x0C PRI...	0	0	inf	0	100
<input type="checkbox"/> <click to add>								

Build Debug Log Interrupt Configuration

This window lists all installed interrupts. Use this window to enable or disable individual interrupts or the interrupt simulation system, and to edit the properties of installed interrupts.

See also *Using the interrupt system*, page 233.

### Requirements

The C-SPY simulator.

### Display area

This area contains these columns:

#### Interrupt

Lists all installed interrupts. Use the checkbox to enable or disable the interrupt.

#### ID

A unique interrupt identifier.

#### Type

Shows the type of the interrupt. The type can be one of:

**Forced**, a single-occasion interrupt defined in the **Available Interrupts** window.

**Single**, a single-occasion interrupt.

**Repeat**, a periodically occurring interrupt.

If the interrupt has been set from a C-SPY macro, the additional part (**macro**) is added, for example: **Repeat(macro)**.

### **Description**

A description of the selected interrupt, if available. The description is retrieved from the selected device description file and consists of a string describing the vector address, request number, enable bit, pending bit, and priority bit, separated by space characters. For interrupts specified using the system macro `__orderInterrupt`, the **Description** box is empty.

### **First activation**

The value of the cycle counter after which the specified interrupt will be generated. Click to edit.

### **Repeat interval**

The periodicity of the interrupt in cycles. Click to edit.

### **Hold time**

How long, in cycles, the interrupt remains pending until removed if it has not been processed. Click to edit. If you specify `inf`, the corresponding pending bit will be set until the interrupt is acknowledged or removed.

### **Variance %**

A timing variation range, as a percentage of the repeat interval, in which the interrupt might occur for a period. For example, if the repeat interval is 100 and the variance 5%, the interrupt might occur anywhere between  $T=95$  and  $T=105$ , to simulate a variation in the timing. Click to edit.

### **Probability %**

The probability, in percent, that the interrupt will actually occur within the specified period. Click to edit.

## Context menu

This context menu is available:

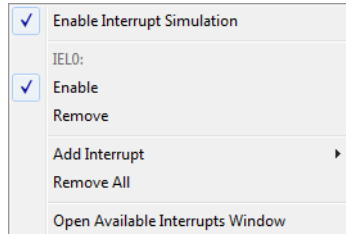

These commands are available:

### Enable Interrupt Simulation

Enables or disables the entire interrupt simulation system. If the interrupt simulation is disabled, the definitions remain but no interrupts are generated. Note that you can also enable and disable installed interrupts individually by using the check box to the left of the interrupt name in the list of installed interrupts.

### Enable

Enables or disables the individual interrupt you clicked on.

### Remove

Removes the individual interrupt you clicked on.

### Add Interrupt

Selects an interrupt to install. The drop-down list contains all available interrupts. Your selection will automatically update the **Description** box. The list is populated with entries from the device description file that you have selected.

### Remove All

Removes all installed interrupts in the window.

### Open Available Interrupts Window

Opens the **Available Interrupts** window, see *Available Interrupts window*, page 240.

## Available Interrupts window

The **Available Interrupts** window is available from the C-SPY driver menu.

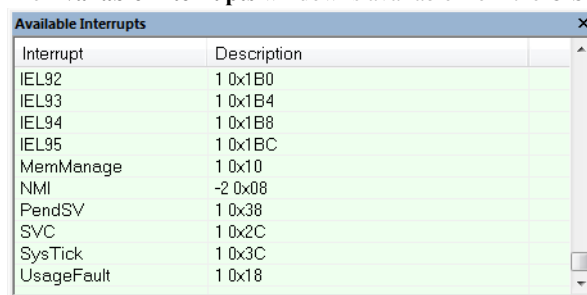

Interrupt	Description
IEL92	1 0x1B0
IEL93	1 0x1B4
IEL94	1 0x1B8
IEL95	1 0x1BC
MemManage	1 0x10
NMI	-2 0x08
PendSV	1 0x38
SVC	1 0x2C
SysTick	1 0x3C
UsageFault	1 0x18

Use this window for an overview of all available interrupts for your project. You can also use it for forcing an interrupt instantly. This is useful when you want to check your interrupt logic and interrupt routines. Just start typing an interrupt name and focus shifts to the first line found with that name.

The hold time for a forced interrupt is infinite, and the interrupt exists until it has been serviced or until a reset of the debug session.

To sort the window contents, click on either the **Interrupt** or the **Description** column header. A second click on the same column header reverses the sort order.

### To force an interrupt:

- 1 Enable the interrupt simulation system, see *Interrupt Configuration window*, page 237.
- 2 Activate the interrupt by using the **Force Interrupt** command available on the context menu.

### Requirements

The C-SPY simulator.

### Display area

This area lists all available interrupts and their definitions. This information is retrieved from the selected device description file. See this file for a detailed description.



## Context menu

This context menu is available:

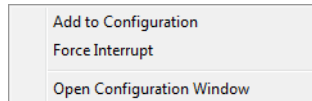

These commands are available:

### Add to Configuration

Installs the selected interrupt and adds it to the **Interrupt Configuration** window.

### Force Interrupt

Triggers the selected interrupt.

### Open Configuration Window

Opens the **Interrupt Configuration** window, see *Interrupt Configuration window*, page 237.

## Interrupt Status window

The **Interrupt Status** window is available from the C-SPY driver menu.

Interrupt	Id	Type	Status	Next Time	Timing [cycles]
NMI	2	Forced	Executing	--	--
IRQ0	1	Repeat (macro)	Suspended	--	--
NMI	0	Repeat	Idle	4345	2000 + n*2345
IRQ0	1	Repeat (macro)	Idle	5020	3010 + n*2010

This window shows the status of all the currently active interrupts, in other words interrupts that are either executing or waiting to be executed.

## Requirements

The C-SPY simulator.

## Display area

This area contains these columns:

### Interrupt

Lists all interrupts.

**ID**

A unique interrupt identifier.

**Type**

The type of the interrupt. The type can be one of:

**Forced**, a single-occasion interrupt defined in the Forced Interrupt window.

**Single**, a single-occasion interrupt.

**Repeat**, a periodically occurring interrupt.

If the interrupt has been set from a C-SPY macro, the additional part (**macro**) is added, for example: **Repeat(macro)**.

**Status**

The state of the interrupt:

**Idle**, the interrupt activation signal is low (deactivated).

**Pending**, the interrupt activation signal is active, but the interrupt has not been yet acknowledged by the interrupt handler.

**Executing**, the interrupt is currently being serviced, that is the interrupt handler function is executing.

**Suspended**, the interrupt is currently suspended due to execution of an interrupt with a higher priority.

**(deleted)** is added to **Executing** and **Suspended** if you have deleted a currently active interrupt. **(deleted)** is removed when the interrupt has finished executing.

**Next Time**

The next time an idle interrupt is triggered. Once a repeatable interrupt starts executing, a copy of the interrupt will appear with the state Idle and the next time set. For interrupts that do not have a next time—that is pending, executing, or suspended—the column will show --.

**Timing**

The timing of the interrupt. For a **Single** and **Forced** interrupt, the activation time is displayed. For a **Repeat** interrupt, the information has the form:  $\text{Activation Time} + n * \text{Repeat Time}$ . For example,  $2000 + n * 2345$ . This means that the first time this interrupt is triggered, is at 2000 cycles and after that with an interval of 2345 cycles.

## Interrupt Log window

The **Interrupt Log** window is available from the C-SPY driver menu.

Time	Interrupt	Status	Program Counter	Execution Time
109.32 us	IRQT0	Triggered	0x13E8	
111.26 us	IRQT0	Enter	0x13F0	
135.78 us	IRQT1	Enter	0x1126	
148.72 us	IRQT1	Leave	0x1378	12.94 us
<i>189.34 us</i>	<i>Overflow</i>			
207.30 us	IRQT0	Leave	0x1126	96.04 us
230.00 us	IRQT0	Triggered	0x1110	
231.34 us	IRQT0	Enter	0x1126	
240.26 us	IRQT0	Leave	0x1122	8.92 us
300.00 us	IRQT1	Enter	---	
371.12 us	IRQT1	Leave	0x1120	71.12 us

Red indicates overflows and italic indicates approximate values

Light-colored rows indicate entrances to interrupts

Darker rows indicate exits from interrupts

This window logs entrances to and exits from interrupts. The C-SPY simulator also logs internal state changes.

The information is useful for debugging the interrupt handling in the target system. When the **Interrupt Log** window is open, it is updated continuously at runtime.

**Note:** There is a limit on the number of saved logs. When this limit is exceeded, the oldest entries in the buffer are erased.

For more information, see *Getting started using interrupt logging*, page 236.

For information about how to get a graphical view of the interrupt events during the execution of your application, see *Timeline window—Interrupt Log graph*, page 248.

### Requirements

The C-SPY simulator.

### Display area

This area contains these columns:

#### Time

The time for the interrupt entrance, based on an internally specified clock frequency.

This column is available when you have selected **Show Time** from the context menu.

### Cycles

The number of cycles from the start of the execution until the event.

This column is available when you have selected **Show Cycles** from the context menu.

### Interrupt

The interrupt as defined in the device description file.

### Status

Shows the event status of the interrupt:

**Triggered**, the interrupt has passed its activation time.

**Forced**, the same as Triggered, but the interrupt was forced from the **Forced Interrupt** window.

**Enter**, the interrupt is currently executing.

**Leave**, the interrupt has been executed.

**Expired**, the interrupt hold time has expired without the interrupt being executed.

**Rejected**, the interrupt has been rejected because the necessary interrupt registers were not set up to accept the interrupt.

### Program Counter

The value of the program counter when the event occurred.

### Execution Time/Cycles

The time spent in the interrupt, calculated using the Enter and Leave timestamps. This includes time spent in any subroutines or other interrupts that occurred in the specific interrupt.

## Context menu

This context menu is available:

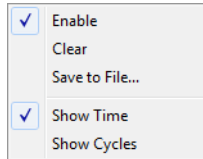

These commands are available:

### Enable

Enables the logging system. The system will log information also when the window is closed.

### Clear

Deletes the log information. Note that this will happen also when you reset the debugger.

### Save to File

Displays a standard file selection dialog box where you can select the destination file for the log information. The entries in the log file are separated by `TAB` and `LF` characters. An **X** in the **Approx** column indicates that the timestamp is an approximation.

### Show Time

Displays the **Time** column.

If the **Time** column is displayed by default in the C-SPY driver you are using, this menu command is not available.

### Show Cycles

Displays the **Cycles** column.

If the **Cycles** column is not supported in the C-SPY driver you are using, this menu command is not available.

## Interrupt Log Summary window

The **Interrupt Log Summary** window is available from the C-SPY driver menu.

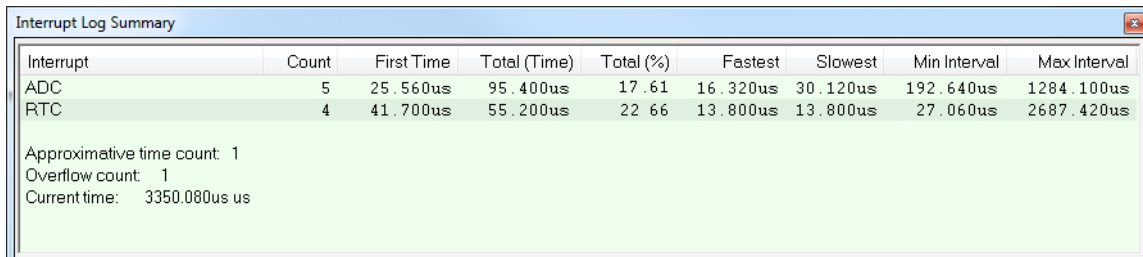

Interrupt	Count	First Time	Total (Time)	Total (%)	Fastest	Slowest	Min Interval	Max Interval
ADC	5	25.560us	95.400us	17.61	16.320us	30.120us	192.640us	1284.100us
RTC	4	41.700us	55.200us	22.66	13.800us	13.800us	27.060us	2687.420us

Approximative time count: 1  
 Overflow count: 1  
 Current time: 3350.080us us

This window displays a summary of logs of entrances to and exits from interrupts.

For more information, see *Getting started using interrupt logging*, page 236.

For information about how to get a graphical view of the interrupt events during the execution of your application, see *Timeline window—Interrupt Log graph*, page 248.

### Requirements

The C-SPY simulator.

### Display area

Each row in this area displays statistics about the specific interrupt based on the log information in these columns:

#### Interrupt

The type of interrupt that occurred.

#### Count

The number of times the interrupt occurred.

#### First time

The first time the interrupt was executed.

#### Total (Time)\*\*

The accumulated time spent in the interrupt.

#### Total (%)

The time in percent of the current time.

#### Fastest\*\*

The fastest execution of a single interrupt of this type.

**Slowest\*\***

The slowest execution of a single interrupt of this type.

**Min interval**

The shortest time between two interrupts of this type.

The interval is specified as the time interval between the entry time for two consecutive interrupts.

**Max interval**

The longest time between two interrupts of this type.

The interval is specified as the time interval between the entry time for two consecutive interrupts.

\*\* Calculated in the same way as for the Execution time/cycles in the **Interrupt Log** window.

**Context menu**

This context menu is available:

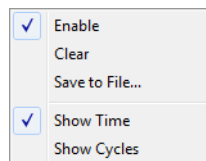

These commands are available:

**Enable**

Enables the logging system. The system will log information also when the window is closed.

**Clear**

Deletes the log information. Note that this will happen also when you reset the debugger.

**Save to File**

Displays a standard file selection dialog box where you can select the destination file for the log information. The entries in the log file are separated by `TAB` and `LF` characters. An **X** in the **Approx** column indicates that the timestamp is an approximation.

**Show Time**

Displays the **Time** column.

If the **Time** column is displayed by default in the C-SPY driver you are using, this menu command is not available.

### Show Cycles

Displays the **Cycles** column.

If the **Cycles** column is not supported in the C-SPY driver you are using, this menu command is not available.

## Timeline window—Interrupt Log graph

The Interrupt Log graph displays interrupts collected by the trace system. In other words, the graph provides a graphical view of the interrupt events during the execution of your application.

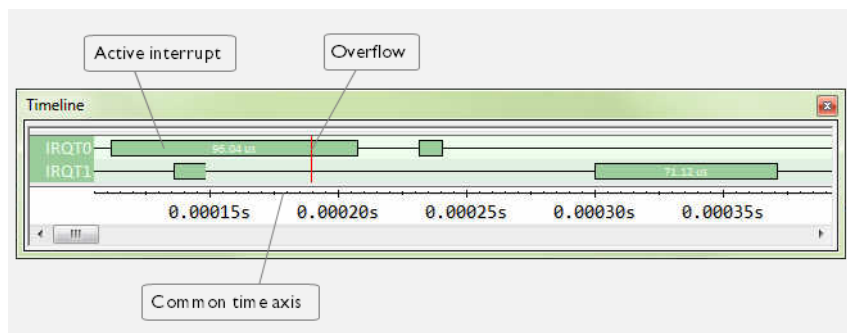

**Note:** There is a limit on the number of saved logs. When this limit is exceeded, the oldest entries in the buffer are erased.

### Requirements

The C-SPY simulator.

### Display area

- The label area at the left end of the graph displays the names of the interrupts.
- The graph itself shows active interrupts as a thick green horizontal bar where the white figure indicates the time spent in the interrupt. This graph is a graphical representation of the information in the **Interrupt Log** window, see *Interrupt Log window*, page 243.
- If the bar is displayed without horizontal borders, there are two possible causes:
  - The interrupt is reentrant and has interrupted itself. Only the innermost interrupt will have borders.



- There are irregularities in the interrupt enter-leave sequence, probably due to missing logs.
- If the bar is displayed without a vertical border, the missing border indicates an approximate time for the log.
- A red vertical line indicates overflow, which means that the communication channel failed to transmit all interrupt logs from the target system.

At the bottom of the window, there is a common time axis that uses seconds as the time unit.

## Context menu

This context menu is available:

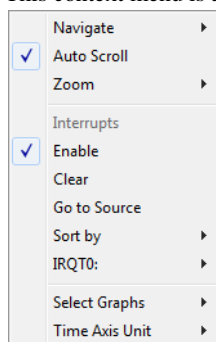

**Note:** The exact contents of the context menu you see on the screen depends on which features that your combination of software and hardware supports. However, the list of menu commands below is complete and covers all possible commands.

These commands are available:

### Navigate

Commands for navigating the graph(s). Choose between:

**Next** moves the selection to the next relevant point in the graph. Shortcut key: right arrow.

**Previous** moves the selection backward to the previous relevant point in the graph. Shortcut key: left arrow.

**First** moves the selection to the first data entry in the graph. Shortcut key: Home.

**Last** moves the selection to the last data entry in the graph. Shortcut key: End.

**End** moves the selection to the last data in any displayed graph, in other words the end of the time axis. Shortcut key: Ctrl+End.

### **Auto Scroll**

Toggles automatic scrolling on or off. When on, the most recently collected data is automatically displayed when you choose **Navigate>End**.

### **Zoom**

Commands for zooming the window, in other words, changing the time scale; choose between:

**Zoom to Selection** makes the current selection fit the window. Shortcut key: Return.

**Zoom In** zooms in on the time scale. Shortcut key: +.

**Zoom Out** zooms out on the time scale. Shortcut key: -.

**10ns, 100ns, 1us**, etc makes an interval of 10 nanoseconds, 100 nanoseconds, 1 microsecond, respectively, fit the window.

**1ms, 10ms**, etc makes an interval of 1 millisecond or 10 milliseconds, respectively, fit the window.

**10m, 1h**, etc makes an interval of 10 minutes or 1 hour, respectively, fit the window.

### **Interrupt**

A heading that shows that the Interrupt Log-specific commands below are available.

#### **Enable**

Toggles the display of the graph on or off. If you disable a graph, that graph will be indicated as **OFF** in the window. If no data has been collected for a graph, **no data** will appear instead of the graph.

#### **Clear**

Deletes the log information. Note that this will happen also when you reset the debugger.

#### **Go To Source**

Displays the corresponding source code in an editor window, if applicable.

#### **Sort by**

Sorts the entries according to their ID or name. The selected order is used in the graph when new interrupts appear.

#### *source*

Goes to the previous/next log for the selected source.

**Select Graphs**

Selects which graphs to be displayed in the **Timeline** window.

**Time Axis Unit**

Selects the unit used in the time axis; choose between **Seconds** and **Cycles**.

If **Cycles** is not available, the graphs are based on different clock sources. In that case you can view cycle values as tooltip information by pointing at the graph with your mouse pointer.



# C-SPY macros

- Introduction to C-SPY macros
- Using C-SPY macros
- Reference information on the macro language
- Reference information on reserved setup macro function names
- Reference information on C-SPY system macros
- Graphical environment for macros

---

## Introduction to C-SPY macros

These topics are covered:

- Reasons for using C-SPY macros
- Briefly about using C-SPY macros
- Briefly about setup macro functions and files
- Briefly about the macro language

### REASONS FOR USING C-SPY MACROS

You can use C-SPY macros either by themselves or in conjunction with complex breakpoints and interrupt simulation to perform a wide variety of tasks. Some examples where macros can be useful:

- Automating the debug session, for instance with trace printouts, printing values of variables, and setting breakpoints.
- Hardware configuring, such as initializing hardware registers.
- Feeding your application with simulated data during runtime.
- Simulating peripheral devices, see the chapter *Interrupts*. This only applies if you are using the simulator driver.
- Developing small debug utility functions, for instance reading I/O input from a file, see the file `setupsimple.mac` located in the directory `\stm8\tutor\`.

## BRIEFLY ABOUT USING C-SPY MACROS

To use C-SPY macros, you should:

- Write your macro variables and functions and collect them in one or several *macro files*
- Register your macros
- Execute your macros.

For registering and executing macros, there are several methods to choose between. Which method you choose depends on which level of interaction or automation you want, and depending on at which stage you want to register or execute your macro.

## BRIEFLY ABOUT SETUP MACRO FUNCTIONS AND FILES

There are some reserved *setup macro function names* that you can use for defining macro functions which will be called at specific times, such as:

- Once after communication with the target system has been established but before downloading the application software
- Once after your application software has been downloaded
- Each time the reset command is issued
- Once when the debug session ends.

To define a macro function to be called at a specific stage, you should define and register a macro function with one of the reserved names. For instance, if you want to clear a specific memory area before you load your application software, the macro setup function `execUserPreload` should be used. This function is also suitable if you want to initialize some CPU registers or memory-mapped peripheral units before you load your application software.

You should define these functions in a *setup macro file*, which you can load before C-SPY starts. Your macro functions will then be automatically registered each time you start C-SPY. This is convenient if you want to automate the initialization of C-SPY, or if you want to register multiple setup macros.

For more information about each setup macro function, see *Reference information on reserved setup macro function names*, page 265.

## BRIEFLY ABOUT THE MACRO LANGUAGE

The syntax of the macro language is very similar to the C language. There are:

- *Macro statements*, which are similar to C statements.
- *Macro functions*, which you can define with or without parameters and return values.

- Predefined built-in *system macros*, similar to C library functions, which perform useful tasks such as opening and closing files, setting breakpoints, and defining simulated interrupts.
- *Macro variables*, which can be global or local, and can be used in C-SPY expressions.
- *Macro strings*, which you can manipulate using predefined system macros.

For more information about the macro language components, see *Reference information on the macro language*, page 260.

### Example

Consider this example of a macro function which illustrates the various components of the macro language:

```
__var oldVal;
CheckLatest(val)
{
    if (oldVal != val)
    {
        __message "Message: Changed from ", oldVal, " to ", val, "\n";
        oldVal = val;
    }
}
```

**Note:** Reserved macro words begin with double underscores to prevent name conflicts.

---

## Using C-SPY macros

These tasks are covered:

- Registering C-SPY macros—an overview
- Executing C-SPY macros—an overview
- Registering and executing using setup macros and setup files
- Executing macros using Quick Watch
- Executing a macro by connecting it to a breakpoint
- Aborting a C-SPY macro

For more examples using C-SPY macros, see:

- The tutorial about simulating an interrupt, which you can find in the Information Center
- *Initializing target hardware before C-SPY starts*, page 43.

## REGISTERING C-SPY MACROS—AN OVERVIEW

C-SPY must know that you intend to use your defined macro functions, and thus you must *register* your macros. There are various ways to register macro functions:

- You can register macro functions during the C-SPY startup sequence, see *Registering and executing using setup macros and setup files*, page 257.
- You can register macros interactively in the **Macro Registration** window, see *Macro Registration window*, page 301. Registered macros appear in the **Debugger Macros** window, see *Debugger Macros window*, page 303.
- You can register a file containing macro function definitions, using the system macro `__registerMacroFile`. This means that you can dynamically select which macro files to register, depending on the runtime conditions. Using the system macro also lets you register multiple files at the same moment. For information about the system macro, see *\_\_registerMacroFile*, page 286.

Which method you choose depends on which level of interaction or automation you want, and depending on at which stage you want to register your macro.

## EXECUTING C-SPY MACROS—AN OVERVIEW

There are various ways to execute macro functions:

- You can execute macro functions during the C-SPY startup sequence and at other predefined stages during the debug session by defining setup macro functions in a setup macro file, see *Registering and executing using setup macros and setup files*, page 257.
- The **Quick Watch** window lets you evaluate expressions, and can thus be used for executing macro functions. For an example, see *Executing macros using Quick Watch*, page 257.
- The **Macro Quicklaunch** window is similar to the **Quick Watch** window, but is more specified on designed for C-SPY macros. See *Macro Quicklaunch window*, page 305.
- A macro can be connected to a breakpoint; when the breakpoint is triggered the macro is executed. For an example, see *Executing a macro by connecting it to a breakpoint*, page 258.

Which method you choose depends on which level of interaction or automation you want, and depending on at which stage you want to execute your macro.



## REGISTERING AND EXECUTING USING SETUP MACROS AND SETUP FILES

It can be convenient to register a macro file during the C-SPY startup sequence. To do this, specify a macro file which you load before starting the debug session. Your macro functions will be automatically registered each time you start the debugger.

If you use the reserved setup macro function names to define the macro functions, you can define exactly at which stage you want the macro function to be executed.

### To define a setup macro function and load it during C-SPY startup:

- 1 Create a new text file where you can define your macro function.

For example:

```
execUserSetup()
{
    ...
    __registerMacroFile("MyMacroUtils.mac");
    __registerMacroFile("MyDeviceSimulation.mac");
}
```

This macro function registers the additional macro files `MyMacroUtils.mac` and `MyDeviceSimulation.mac`. Because the macro function is defined with the function name `execUserSetup`, it will be executed directly after your application has been downloaded.

- 2 Save the file using the filename extension `mac`.
- 3 Before you start C-SPY, choose **Project>Options>Debugger>Setup**. Select **Use Setup file** and choose the macro file you just created.

The macros will now be registered during the C-SPY startup sequence.

## EXECUTING MACROS USING QUICK WATCH

The **Quick Watch** window lets you dynamically choose when to execute a macro function.

- 1 Consider this simple macro function that checks the status of a timer enable bit:

```
TimerStatus()
{
    if ((TimerStatreg & 0x01) != 0) /* Checks the status of reg */
        return "Timer enabled"; /* C-SPY macro string used */
    else
        return "Timer disabled"; /* C-SPY macro string used */
}
```

- 2 Save the macro function using the filename extension `mac`.
- 3 To load the macro file, choose **View>Macros>Macro Registration**. The **Macro Registration** window is displayed. Click **Add** and locate the file using the file browser. The macro file appears in the list of macros in the **Macro Registration** window.
- 4 Select the macro you want to register and your macro will appear in the **Debugger Macros** window.
- 5 Choose **View>Quick Watch** to open the **Quick Watch** window, type the macro call `TimerStatus()` in the text field and press Return,

Alternatively, in the macro file editor window, select the macro function name `TimerStatus()`. Right-click, and choose **Quick Watch** from the context menu that appears.

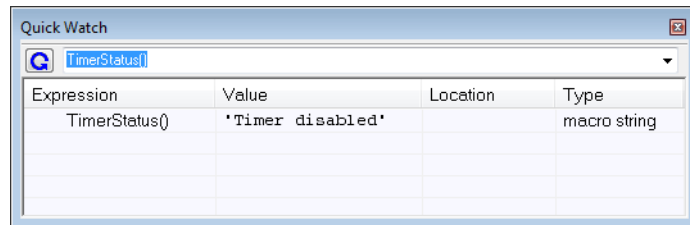

The macro will automatically be displayed in the **Quick Watch** window.

For more information, see *Quick Watch window*, page 95.

## EXECUTING A MACRO BY CONNECTING IT TO A BREAKPOINT

You can connect a macro to a breakpoint. The macro will then be executed when the breakpoint is triggered. The advantage is that you can stop the execution at locations of particular interest and perform specific actions there.



For instance, you can easily produce log reports containing information such as how the values of variables, symbols, or registers change. To do this you might set a breakpoint on a suspicious location and connect a log macro to the breakpoint. After the execution you can study how the values of the registers have changed.

### To create a log macro and connect it to a breakpoint:

- 1 Assume this skeleton of a C function in your application source code:

```
int fact(int x)
{
    ...
}
```

- 2 Create a simple log macro function like this example:

```
logfact ()
{
  __message "fact (" ,x, " )";
}
```

The `__message` statement will log messages to the Log window.

Save the macro function in a macro file, with the filename extension `mac`.

- 3 To register the macro, choose **View>Macros>Macro Registration** to open the **Macro Registration** window and add your macro file to the list. Select the file to register it. Your macro function will appear in the **Debugger Macros** window.
- 4 To set a code breakpoint, click the **Toggle Breakpoint** button on the first statement within the function `fact` in your application source code. Choose **View>Breakpoints** to open the **Breakpoints** window. Select your breakpoint in the list of breakpoints and choose the **Edit** command from the context menu.
- 5 To connect the log macro function to the breakpoint, type the name of the macro function, `logfact ()`, in the **Action** field and click **Apply**. Close the dialog box.
- 6 Execute your application source code. When the breakpoint is triggered, the macro function will be executed. You can see the result in the **Log** window.
  - Note that the expression in the **Action** field is evaluated only when the breakpoint causes the execution to really stop. If you want to log a value and then automatically continue execution, you can either:
    - Use a **Log** breakpoint, see *Log breakpoints dialog box*, page 119
    - Use the **Condition** field instead of the **Action** field. For an example, see *Performing a task and continuing execution*, page 110.
- 7 You can easily enhance the log macro function by, for instance, using the `__fmessage` statement instead, which will print the log information to a file. For information about the `__fmessage` statement, see *Formatted output*, page 263.

For an example where a serial port input buffer is simulated using the method of connecting a macro to a breakpoint, see the tutorial *Simulating an interrupt* in the Information Center.

## ABORTING A C-SPY MACRO

### To abort a C-SPY macro:

- 1 Press **Ctrl+Shift+.** (period) for a short while.
- 2 A message that says that the macro has terminated is displayed in the **Debug Log** window.

This method can be used if you suspect that something is wrong with the execution, for example because it seems not to terminate in a reasonable time.

---

## Reference information on the macro language

Reference information about:

- *Macro functions*, page 260
- *Macro variables*, page 260
- *Macro parameters*, page 261
- *Macro strings*, page 261
- *Macro statements*, page 262
- *Formatted output*, page 263.

### MACRO FUNCTIONS

C-SPY macro functions consist of C-SPY variable definitions and macro statements which are executed when the macro is called. An unlimited number of parameters can be passed to a macro function, and macro functions can return a value on exit.

A C-SPY macro has this form:

```
macroName (parameterList)
{
    macroBody
}
```

where *parameterList* is a list of macro parameters separated by commas, and *macroBody* is any series of C-SPY variable definitions and C-SPY statements.

Type checking is neither performed on the values passed to the macro functions nor on the return value.

### MACRO VARIABLES

A macro variable is a variable defined and allocated outside your application. It can then be used in a C-SPY expression, or you can assign application data—values of the variables in your application—to it. For more information about C-SPY expressions, see *C-SPY expressions*, page 78.

The syntax for defining one or more macro variables is:

```
__var nameList;
```

where *nameList* is a list of C-SPY variable names separated by commas.

A macro variable defined outside a macro body has global scope, and it exists throughout the whole debugging session. A macro variable defined within a macro body is created when its definition is executed and destroyed on return from the macro.

By default, macro variables are treated as signed integers and initialized to 0. When a C-SPY variable is assigned a value in an expression, it also acquires the type of that expression. For example:

Expression	What it means
<code>myvar = 3.5;</code>	<code>myvar</code> is now type <code>double</code> , value <code>3.5</code> .
<code>myvar = (int*)i;</code>	<code>myvar</code> is now type <code>pointer to int</code> , and the value is the same as <code>i</code> .

Table 13: Examples of C-SPY macro variables

In case of a name conflict between a C symbol and a C-SPY macro variable, C-SPY macro variables have a higher precedence than C variables. Note that macro variables are allocated on the debugger host and do not affect your application.

## MACRO PARAMETERS

A macro parameter is intended for parameterization of device support. The named parameter will behave as a normal C-SPY macro variable with these differences:

- The parameter definition can have an initializer
- Values of a parameters can be set through options (either in the IDE or in `cspybat`).
- A value set from an option will take precedence over a value set by an initializer
- A parameter must have an initializer, be set through an option, or both. Otherwise, it has an undefined value, and accessing it will cause a runtime error.

The syntax for defining one or more macro parameters is:

```
__param param[ = value, ...;]
```

Use the command line option `--macro_param` to specify a value to a parameter, see `--macro_param`, page 316.

## MACRO STRINGS

In addition to C types, macro variables can hold values of *macro strings*. Note that macro strings differ from C language strings.

When you write a string literal, such as `"Hello!"`, in a C-SPY expression, the value is a macro string. It is not a C-style character pointer `char*`, because `char*` must point to a sequence of characters in target memory and C-SPY cannot expect any string literal to actually exist in target memory.

You can manipulate a macro string using a few built-in macro functions, for example `__strFind` or `__subString`. The result can be a new macro string. You can

concatenate macro strings using the + operator, for example `str + "tail"`. You can also access individual characters using subscription, for example `str[3]`. You can get the length of a string using `sizeof(str)`. Note that a macro string is not NULL-terminated.

The macro function `__toString` is used for converting from a NULL-terminated C string in your application (`char*` or `char[]`) to a macro string. For example, assume this definition of a C string in your application:

```
char const *cstr = "Hello";
```

Then examine these macro examples:

```
__var str;          /* A macro variable */
str = cstr          /* str is now just a pointer to char */
sizeof str         /* same as sizeof (char*), typically 2 or 4 */
str = __toString(cstr,512) /* str is now a macro string */
sizeof str        /* 5, the length of the string */
str[1]           /* 101, the ASCII code for 'e' */
str += " World!" /* str is now "Hello World!" */
```

See also *Formatted output*, page 263.

## MACRO STATEMENTS

Statements are expected to behave in the same way as the corresponding C statements would do. The following C-SPY macro statements are accepted:

### Expressions

```
expression;
```

For more information about C-SPY expressions, see *C-SPY expressions*, page 78.

### Conditional statements

```
if (expression)
    statement
```

```
if (expression)
    statement
else
    statement
```

## Loop statements

```
for (init_expression; cond_expression; update_expression)
    statement
```

```
while (expression)
    statement
```

```
do
    statement
while (expression);
```

## Return statements

```
return;
```

```
return expression;
```

If the return value is not explicitly set, signed int 0 is returned by default.

## Blocks

Statements can be grouped in blocks.

```
{
    statement1
    statement2
    .
    .
    statementN
}
```

## FORMATTED OUTPUT

C-SPY provides various methods for producing formatted output:

<code>__message <i>argList</i>;</code>	Prints the output to the <b>Debug Log</b> window.
<code>__fmessage <i>file</i>, <i>argList</i>;</code>	Prints the output to the designated file.
<code>__smessage <i>argList</i>;</code>	Returns a string containing the formatted output.

where *argList* is a comma-separated list of C-SPY expressions or strings, and *file* is the result of the `__openFile` system macro, see `__openFile`, page 280.

To produce messages in the **Debug Log** window:

```
var1 = 42;
var2 = 37;
__message "This line prints the values ", var1, " and ", var2,
" in the Log window.";
```

This produces this message in the Log window:

This line prints the values 42 and 37 in the Log window.

To write the output to a designated file:

```
__fmessage myfile, "Result is ", res, "!\n";
```

To produce strings:

```
myMacroVar = __smessage 42, " is the answer.";
myMacroVar now contains the string "42 is the answer.".
```

### Specifying display format of arguments

To override the default display format of a scalar argument (number or pointer) in *argList*, suffix it with a `:` followed by a format specifier. Available specifiers are:

<code>%b</code>	for binary scalar arguments
<code>%o</code>	for octal scalar arguments
<code>%d</code>	for decimal scalar arguments
<code>%x</code>	for hexadecimal scalar arguments
<code>%c</code>	for character scalar arguments

These match the formats available in the **Watch** and **Locals** windows, but number prefixes and quotes around strings and characters are not printed. Another example:

```
__message "The character '", cvar:%c, "' has the decimal value
", cvar;
```

Depending on the value of the variables, this produces this message:

The character 'A' has the decimal value 65

**Note:** A character enclosed in single quotes (a character literal) is an integer constant and is not automatically formatted as a character. For example:

```
__message 'A', " is the numeric value of the character ",
'A':%c;
```



would produce:

```
65 is the numeric value of the character A
```

**Note:** The default format for certain types is primarily designed to be useful in the **Watch** window and other related windows. For example, a value of type `char` is formatted as `'A' (0x41)`, while a pointer to a character (potentially a C string) is formatted as `0x8102 "Hello"`, where the string part shows the beginning of the string (currently up to 60 characters).

When printing a value of type `char*`, use the `%x` format specifier to print just the pointer value in hexadecimal notation, or use the system macro `__toString` to get the full string value.

---

## Reference information on reserved setup macro function names

There are reserved setup macro function names that you can use for defining your setup macro functions. By using these reserved names, your function will be executed at defined stages during execution. For more information, see *Briefly about setup macro functions and files*, page 254.

Reference information about:

- `execUserPreload`
- `execUserExecutionStarted`
- `execUserExecutionStopped`
- `execUserSetup`
- `execUserPreReset`
- `execUserReset`
- `execUserExit`

### **execUserPreload**

Syntax	<code>execUserPreload</code>
For use with	All C-SPY drivers.
Description	Called after communication with the target system is established but before downloading the target application.  Implement this macro to initialize memory locations and/or registers which are vital for loading data properly.

## execUserExecutionStarted

Syntax	<code>execUserExecutionStarted</code>
For use with	All C-SPY drivers.
Description	Called when the debugger is about to start or resume execution. The macro is not called when performing a one-instruction assembler step, in other words, Step or Step Into in the <b>Disassembly</b> window.

## execUserExecutionStopped

Syntax	<code>execUserExecutionStopped</code>
For use with	All C-SPY drivers.
Description	Called when the debugger has stopped execution. The macro is not called when performing a one-instruction assembler step, in other words, Step or Step Into in the <b>Disassembly</b> window.

## execUserSetup

Syntax	<code>execUserSetup</code>
For use with	All C-SPY drivers.
Description	Called once after the target application is downloaded. Implement this macro to set up the memory map, breakpoints, interrupts, register macro files, etc.



If you define interrupts or breakpoints in a macro file that is executed at system start (using `execUserSetup`) we strongly recommend that you also make sure that they are removed at system shutdown (using `execUserExit`). An example is available in `SetupSimple.mac`, see the tutorials in the Information Center.

The reason for this is that the simulator saves interrupt settings between sessions and if they are not removed they will get duplicated every time `execUserSetup` is executed again. This seriously affects the execution speed.

## execUserPreReset

Syntax	<code>execUserPreReset</code>
For use with	All C-SPY drivers.
Description	Called each time just before the reset command is issued. Implement this macro to set up any required device state.

## execUserReset

Syntax	<code>execUserReset</code>
For use with	All C-SPY drivers.
Description	Called each time just after the reset command is issued. Implement this macro to set up and restore data.

## execUserExit

Syntax	<code>execUserExit</code>
For use with	All C-SPY drivers.
Description	Called once when the debug session ends. Implement this macro to save status data etc.

## Reference information on C-SPY system macros

This section gives reference information about each of the C-SPY system macros.

This table summarizes the pre-defined system macros:

Macro	Description
<code>__abortLaunch</code>	Aborts the launch of the debugger
<code>__cancelAllInterrupts</code>	Cancels all ordered interrupts
<code>__cancelInterrupt</code>	Cancels an interrupt
<code>__clearBreak</code>	Clears a breakpoint

*Table 14: Summary of system macros*

Macro	Description
<code>__closeFile</code>	Closes a file that was opened by <code>__openFile</code>
<code>__delay</code>	Delays execution
<code>__disableInterrupts</code>	Disables generation of interrupts
<code>__driverType</code>	Verifies the driver type
<code>__enableInterrupts</code>	Enables generation of interrupts
<code>__evaluate</code>	Interprets the input string as an expression and evaluates it.
<code>__fillMemory8</code>	Fills a specified memory area with a byte value.
<code>__fillMemory16</code>	Fills a specified memory area with a 2-byte value.
<code>__fillMemory32</code>	Fills a specified memory area with a 4-byte value.
<code>__isBatchMode</code>	Checks if C-SPY is running in batch mode or not.
<code>__loadImage</code>	Loads an image.
<code>__memoryRestore</code>	Restores the contents of a file to a specified memory zone
<code>__memorySave</code>	Saves the contents of a specified memory area to a file
<code>__messageBoxYesCancel</code>	Displays a Yes/Cancel dialog box for user interaction
<code>__messageBoxYesNo</code>	Displays a Yes/No dialog box for user interaction
<code>__openFile</code>	Opens a file for I/O operations
<code>__orderInterrupt</code>	Generates an interrupt
<code>__popSimulatorInterruptExecutingStack</code>	Informs the interrupt simulation system that an interrupt handler has finished executing
<code>__readFile</code>	Reads from the specified file
<code>__readFileByte</code>	Reads one byte from the specified file
<code>__readMemory8,</code> <code>__readMemoryByte</code>	Reads one byte from the specified memory location
<code>__readMemory16</code>	Reads two bytes from the specified memory location
<code>__readMemory32</code>	Reads four bytes from the specified memory location
<code>__registerMacroFile</code>	Registers macros from the specified file
<code>__resetFile</code>	Rewinds a file opened by <code>__openFile</code>
<code>__setCodeBreak</code>	Sets a code breakpoint
<code>__setDataBreak</code>	Sets a data breakpoint
<code>__setDataLogBreak</code>	Sets a data log breakpoint

Table 14: Summary of system macros

Macro	Description
<code>__setLogBreak</code>	Sets a log breakpoint
<code>__setSimBreak</code>	Sets a simulation breakpoint
<code>__setTraceStartBreak</code>	Sets a trace start breakpoint
<code>__setTraceStopBreak</code>	Sets a trace stop breakpoint
<code>__sourcePosition</code>	Returns the file name and source location if the current execution location corresponds to a source location
<code>__strFind</code>	Searches a given string for the occurrence of another string
<code>__subString</code>	Extracts a substring from another string
<code>__targetDebuggerVersion</code>	Returns the version of the target debugger
<code>__toLower</code>	Returns a copy of the parameter string where all the characters have been converted to lower case
<code>__toString</code>	Prints strings
<code>__toUpper</code>	Returns a copy of the parameter string where all the characters have been converted to upper case
<code>__unloadImage</code>	Unloads a debug image
<code>__writeFile</code>	Writes to the specified file
<code>__writeFileByte</code>	Writes one byte to the specified file
<code>__writeMemory8,</code> <code>__writeMemoryByte</code>	Writes one byte to the specified memory location
<code>__writeMemory16</code>	Writes a two-byte word to the specified memory location
<code>__writeMemory32</code>	Writes a four-byte word to the specified memory location

Table 14: Summary of system macros

## `__abortLaunch`

Syntax	<code>__abortLaunch (message)</code>
Parameters	<i>message</i> A string that is printed as an error message when the macro executes.
Return value	None.
For use with	All C-SPY drivers.

Description	This macro can be used for aborting a debugger launch, for example if another macro sees that something goes wrong during initialization and cannot perform a proper setup. This is an emergency exit, not a recommended way to end a debug session like the C library function <code>abort()</code> .
Example	<pre>if (!__messageBoxYesCancel("Do you want to mass erase to unlock                            the device?", "Unlocking device")) { __abortLaunch("Unlock canceled. Debug session cannot                 continue."); }</pre>

## \_\_cancelAllInterrupts

Syntax	<code>__cancelAllInterrupts()</code>
Return value	<code>int 0</code>
For use with	The C-SPY Simulator.
Description	Cancels all ordered interrupts.

## \_\_cancelInterrupt

Syntax	<code>__cancelInterrupt(<i>interrupt_id</i>)</code>
Parameters	<p><i>interrupt_id</i></p> <p>The value returned by the corresponding <code>__orderInterrupt</code> macro call (unsigned long).</p>

Return value

Result	Value
Successful	<code>int 0</code>
Unsuccessful	Non-zero error number

Table 15: `__cancelInterrupt` return values

For use with	The C-SPY Simulator.
Description	Cancels the specified interrupt.

## \_\_clearBreak

Syntax	<code>__clearBreak(<i>break_id</i>)</code>
Parameters	<i>break_id</i> The value returned by any of the set breakpoint macros.
Return value	<code>int 0</code>
For use with	All C-SPY drivers.
Description	Clears a user-defined breakpoint.
See also	<i>Breakpoints</i> , page 101.

## \_\_closeFile

Syntax	<code>__closeFile(<i>fileHandle</i>)</code>
Parameters	<i>fileHandle</i> A macro variable used as filehandle by the <code>__openFile</code> macro.
Return value	<code>int 0</code>
For use with	All C-SPY drivers.
Description	Closes a file previously opened by <code>__openFile</code> .

## \_\_delay

Syntax	<code>__delay(<i>value</i>)</code>
Parameters	<i>value</i> The number of milliseconds to delay execution.
Return value	<code>int 0</code>
For use with	All C-SPY drivers.
Description	Delays execution the specified number of milliseconds.

## \_\_disableInterrupts

Syntax `__disableInterrupts()`

Return value

Result	Value
Successful	int 0
Unsuccessful	Non-zero error number

Table 16: `__disableInterrupts` return values

For use with The C-SPY Simulator.

Description Disables the generation of interrupts.

## \_\_driverType

Syntax `__driverType(driver_id)`

Parameters

*driver\_id*

A string corresponding to the driver you want to check for. Choose one of these:

"sim" corresponds to the simulator driver.

"stlink" corresponds to the C-SPY ST-LINK driver.

"stice" corresponds to the C-SPY STice driver.

Return value

Result	Value
Successful	1
Unsuccessful	0

Table 17: `__driverType` return values

For use with All C-SPY drivers

Description Checks to see if the current C-SPY driver is identical to the driver type of the *driver\_id* parameter.

Example

`__driverType("sim")`

If the simulator is the current driver, the value 1 is returned. Otherwise 0 is returned.



## \_\_enableInterrupts

Syntax `__enableInterrupts()`

Return value

Result	Value
Successful	int 0
Unsuccessful	Non-zero error number

Table 18: `__enableInterrupts` return values

For use with The C-SPY Simulator.

Description Enables the generation of interrupts.

## \_\_evaluate

Syntax `__evaluate(string, valuePtr)`

Parameters

*string*

Expression string.

*valuePtr*

Pointer to a macro variable storing the result.

Return value

Result	Value
Successful	int 0
Unsuccessful	int 1

Table 19: `__evaluate` return values

For use with All C-SPY drivers.

Description This macro interprets the input string as an expression and evaluates it. The result is stored in a variable pointed to by *valuePtr*.

Example

This example assumes that the variable `i` is defined and has the value 5:

```
__evaluate("i + 3", &myVar)
```

The macro variable `myVar` is assigned the value 8.

**\_\_fillMemory8**

Syntax	<code>__fillMemory8(value, address, zone, length, format)</code>								
Parameters	<p><i>value</i> An integer that specifies the value.</p> <p><i>address</i> An integer that specifies the memory start address.</p> <p><i>zone</i> A string that specifies the memory zone, see <i>C-SPY memory zones</i>, page 128.</p> <p><i>length</i> An integer that specifies how many bytes are affected.</p> <p><i>format</i> One of these alternatives:</p> <table> <tr> <td>Copy</td> <td><i>value</i> will be copied to the specified memory area.</td> </tr> <tr> <td>AND</td> <td>An AND operation will be performed between <i>value</i> and the existing contents of memory before writing the result to memory.</td> </tr> <tr> <td>OR</td> <td>An OR operation will be performed between <i>value</i> and the existing contents of memory before writing the result to memory.</td> </tr> <tr> <td>XOR</td> <td>An XOR operation will be performed between <i>value</i> and the existing contents of memory before writing the result to memory.</td> </tr> </table>	Copy	<i>value</i> will be copied to the specified memory area.	AND	An AND operation will be performed between <i>value</i> and the existing contents of memory before writing the result to memory.	OR	An OR operation will be performed between <i>value</i> and the existing contents of memory before writing the result to memory.	XOR	An XOR operation will be performed between <i>value</i> and the existing contents of memory before writing the result to memory.
Copy	<i>value</i> will be copied to the specified memory area.								
AND	An AND operation will be performed between <i>value</i> and the existing contents of memory before writing the result to memory.								
OR	An OR operation will be performed between <i>value</i> and the existing contents of memory before writing the result to memory.								
XOR	An XOR operation will be performed between <i>value</i> and the existing contents of memory before writing the result to memory.								
Return value	<code>int 0</code>								
For use with	All C-SPY drivers.								
Description	Fills a specified memory area with a byte value.								
Example	<code>__fillMemory8(0x80, 0x700, "", 0x10, "OR");</code>								

**\_\_fillMemory16**

Syntax	<code>__fillMemory16(value, address, zone, length, format)</code>
Parameters	<p><i>value</i> An integer that specifies the value.</p>

	<i>address</i>	An integer that specifies the memory start address.
	<i>zone</i>	A string that specifies the memory zone, see <i>C-SPY memory zones</i> , page 128.
	<i>length</i>	An integer that defines how many 2-byte entities to be affected.
	<i>format</i>	One of these alternatives: <ul style="list-style-type: none"> <li>Copy      <i>value</i> will be copied to the specified memory area.</li> <li>AND        An AND operation will be performed between <i>value</i> and the existing contents of memory before writing the result to memory.</li> <li>OR         An OR operation will be performed between <i>value</i> and the existing contents of memory before writing the result to memory.</li> <li>XOR        An XOR operation will be performed between <i>value</i> and the existing contents of memory before writing the result to memory.</li> </ul>
Return value	int 0	
For use with	All C-SPY drivers.	
Description	Fills a specified memory area with a 2-byte value.	
Example	<pre>__fillMemory16(0xCDCD, 0x7000, "", 0x200, "Copy");</pre>	

## **\_\_fillMemory32**

Syntax	<pre>__fillMemory32(<i>value</i>, <i>address</i>, <i>zone</i>, <i>length</i>, <i>format</i>)</pre>
Parameters	<p><i>value</i></p> <p>An integer that specifies the value.</p> <p><i>address</i></p> <p>An integer that specifies the memory start address.</p> <p><i>zone</i></p> <p>A string that specifies the memory zone, see <i>C-SPY memory zones</i>, page 128.</p>

*length*

An integer that defines how many 4-byte entities to be affected.

*format*

One of these alternatives:

Copy	<i>value</i> will be copied to the specified memory area.
AND	An AND operation will be performed between <i>value</i> and the existing contents of memory before writing the result to memory.
OR	An OR operation will be performed between <i>value</i> and the existing contents of memory before writing the result to memory.
XOR	An XOR operation will be performed between <i>value</i> and the existing contents of memory before writing the result to memory.

Return value	int 0
For use with	All C-SPY drivers.
Description	Fills a specified memory area with a 4-byte value.
Example	<code>__fillMemory32(0x0000FFFF, 0x4000, "", 0x1000, "XOR");</code>

## **\_\_isBatchMode**

Syntax	<code>__isBatchMode()</code>
--------	------------------------------

Return value

Result	Value
True	int 1
False	int 0

Table 20: *\_\_isBatchMode* return values

For use with	All C-SPY drivers.
--------------	--------------------

Description	This macro returns True if the debugger is running in batch mode, otherwise it returns False.
-------------	---

## \_\_loadImage

Syntax	<code>__loadImage(path, offset, debugInfoOnly)</code>
Parameters	<p><i>path</i></p> <p>A string that identifies the path to the image to download. The path must either be absolute or use argument variables. For information about argument variables, see the <i>IDE Project Management and Building Guide for STM8</i>.</p> <p><i>offset</i></p> <p>An integer that identifies the offset to the destination address for the downloaded image.</p> <p><i>debugInfoOnly</i></p> <p>A non-zero integer value if no code or data should be downloaded to the target system, which means that C-SPY will only read the debug information from the debug file. Or, 0 (zero) for download.</p>

### Return value

Value	Result
Non-zero integer number	A unique module identification.
int 0	Loading failed.

Table 21: \_\_loadImage return values

For use with	All C-SPY drivers.
Description	Loads an image (debug file).
Example 1	<p>Your system consists of a ROM library and an application. The application is your active project, but you have a debug file corresponding to the library. In this case you can add this macro call in the <code>execUserSetup</code> macro in a C-SPY macro file, which you associate with your project:</p> <pre>__loadImage("ROMfile", 0x8000, 1);</pre> <p>This macro call loads the debug information for the ROM library <i>ROMfile</i> without downloading its contents (because it is presumably already in ROM). Then you can debug your application together with the library.</p>
Example 2	<p>Your system consists of a ROM library and an application, but your main concern is the library. The library needs to be programmed into flash memory before a debug session. While you are developing the library, the library project must be the active project in the</p>

IDE. In this case you can add this macro call in the `execUserSetup` macro in a C-SPY macro file, which you associate with your project:

```
__loadImage("ApplicationFile", 0x8000, 0);
```

The macro call loads the debug information for the application and downloads its contents (presumably into RAM). Then you can debug your library together with the application.

See also

*Images*, page 325 and *Loading multiple images*, page 41.

## \_\_memoryRestore

Syntax

```
__memoryRestore(zone, filename)
```

Parameters

*zone*

A string that specifies the memory zone, see *C-SPY memory zones*, page 128.

*filename*

A string that specifies the file to be read. The filename must include a path, which must either be absolute or use argument variables. For information about argument variables, see the *IDE Project Management and Building Guide for STM8*.

Return value

int 0

For use with

All C-SPY drivers.

Description

Reads the contents of a file and saves it to the specified memory zone.

Example

```
__memoryRestore("", "c:\\temp\\saved_memory.hex");
```

See also

*Memory Restore dialog box*, page 140.

## \_\_memorySave

Syntax

```
__memorySave(start, stop, format, filename)
```

Parameters

*start*

A string that specifies the first location of the memory area to be saved.

*stop*

A string that specifies the last location of the memory area to be saved.

*format*

A string that specifies the format to be used for the saved memory. Choose between:

intel-extended

motorola

motorola-s19

motorola-s28

motorola-s37.

*filename*

A string that specifies the file to write to. The filename must include a path, which must either be absolute or use argument variables. For information about argument variables, see the *IDE Project Management and Building Guide for STM8*.

Return value	int 0
For use with	All C-SPY drivers.
Description	Saves the contents of a specified memory area to a file.
Example	<pre>__memorySave(":0x00", ":0xFF", "intel-extended", "c:\\temp\\saved_memory.hex");</pre>
See also	<i>Memory Save dialog box</i> , page 139.

**\_\_messageBoxYesCancel**

Syntax	<code>__messageBoxYesCancel(<i>message</i>, <i>caption</i>)</code>
Parameters	<p><i>message</i></p> <p>A message that will appear in the message box.</p> <p><i>caption</i></p> <p>The title that will appear in the message box.</p>
Return value	

Result	Value
Yes	1

Table 22: `__messageBoxYesCancel` return values

Result	Value
No	0

Table 22: `__messageBoxYesCancel` return values

For use with	All C-SPY drivers.
Description	Displays a Yes/Cancel dialog box when called and returns the user input. Typically, this is useful for creating macros that require user interaction.

## `__messageBoxYesNo`

Syntax	<code>__messageBoxYesNo(message, caption)</code>
Parameters	<p><i>message</i></p> <p>A message that will appear in the message box.</p> <p><i>caption</i></p> <p>The title that will appear in the message box.</p>
Return value	

Result	Value
Yes	1
No	0

Table 23: `__messageBoxYesNo` return values

For use with	All C-SPY drivers.
Description	Displays a Yes/No dialog box when called and returns the user input. Typically, this is useful for creating macros that require user interaction.

## `__openFile`

Syntax	<code>__openFile(filename, access)</code>
Parameters	<p><i>filename</i></p> <p>The file to be opened. The filename must include a path, which must either be absolute or use argument variables. For information about argument variables, see the <i>IDE Project Management and Building Guide for STM8</i>.</p> <p><i>access</i></p> <p>The access type (string).</p>



These are mandatory but mutually exclusive:

"a" append, new data will be appended at the end of the open file

"r" read (by default in text mode; combine with b for binary mode: rb)

"w" write (by default in text mode; combine with b for binary mode: wb)

These are optional and mutually exclusive:

"b" binary, opens the file in binary mode

"t" ASCII text, opens the file in text mode

This access type is optional:

"+" together with r, w, or a; r+ or w+ is *read* and *write*, while a+ is *read* and *append*

Return value

Result	Value
Successful	The file handle
Unsuccessful	An invalid file handle, which tests as False

Table 24: `__openFile` return values

For use with

All C-SPY drivers.

Description

Opens a file for I/O operations. The default base directory of this macro is where the currently open project file (\*.ewp) is located. The argument to `__openFile` can specify a location relative to this directory. In addition, you can use argument variables such as `$PROJ_DIR$` and `$TOOLKIT_DIR$` in the path argument.

Example

```
__var myFileHandle;          /* The macro variable to contain */
                             /* the file handle */
myFileHandle = __openFile("$PROJ_DIR$\\Debug\\Exe\\test.tst",
"r");
if (myFileHandle)
{
    /* successful opening */
}
```

See also

For information about argument variables, see the *IDE Project Management and Building Guide for STM8*.

## **\_\_orderInterrupt**

Syntax	<code>__orderInterrupt(<i>specification</i>, <i>first_activation</i>, <i>repeat_interval</i>, <i>variance</i>, <i>infinite_hold_time</i>, <i>hold_time</i>, <i>probability</i>)</code>
Parameters	<p><i>specification</i></p> <p>The interrupt (string). The specification can either be the full specification used in the device description file (<code>ddf</code>) or only the name. In the latter case the interrupt system will automatically get the description from the device description file.</p> <p><i>first_activation</i></p> <p>The first activation time in cycles (integer)</p> <p><i>repeat_interval</i></p> <p>The periodicity in cycles (integer)</p> <p><i>variance</i></p> <p>The timing variation range in percent (integer between 0 and 100)</p> <p><i>infinite_hold_time</i></p> <p>1 if infinite, otherwise 0.</p> <p><i>hold_time</i></p> <p>The hold time (integer)</p> <p><i>probability</i></p> <p>The probability in percent (integer between 0 and 100)</p>
Return value	The macro returns an interrupt identifier (unsigned long). If the syntax of <i>specification</i> is incorrect, it returns -1.
For use with	The C-SPY Simulator.
Description	Generates an interrupt.
Example	<p>This example generates a repeating interrupt using an infinite hold time first activated after 4000 cycles:</p> <pre>__orderInterrupt( "UART1_R_RXNE", 4000, 2000, 0, 1, 0, 100 );</pre>

## \_\_popSimulatorInterruptExecutingStack

Syntax	<code>__popSimulatorInterruptExecutingStack(void)</code>
Return value	<code>int 0</code>
For use with	The C-SPY Simulator.
Description	<p>Informs the interrupt simulation system that an interrupt handler has finished executing, as if the normal instruction used for returning from an interrupt handler was executed.</p> <p>This is useful if you are using interrupts in such a way that the normal instruction for returning from an interrupt handler is not used, for example in an operating system with task-switching. In this case, the interrupt simulation system cannot automatically detect that the interrupt has finished executing.</p>
See also	<i>Simulating an interrupt in a multi-task system</i> , page 235.

## \_\_readFile

Syntax	<code>__readFile(fileHandle, valuePtr)</code>						
Parameters	<p><i>fileHandle</i> A macro variable used as filehandle by the <code>__openFile</code> macro.</p> <p><i>valuePtr</i> A pointer to a variable.</p>						
Return value	<table border="1"> <thead> <tr> <th>Result</th> <th>Value</th> </tr> </thead> <tbody> <tr> <td>Successful</td> <td>0</td> </tr> <tr> <td>Unsuccessful</td> <td>Non-zero error number</td> </tr> </tbody> </table> <p><i>Table 25: __readFile return values</i></p>	Result	Value	Successful	0	Unsuccessful	Non-zero error number
Result	Value						
Successful	0						
Unsuccessful	Non-zero error number						
For use with	All C-SPY drivers.						
Description	<p>Reads a sequence of hexadecimal digits from the given file and converts them to an <code>unsigned long</code> which is assigned to the <i>value</i> parameter, which should be a pointer to a macro variable.</p> <p>Only printable characters representing hexadecimal digits and white-space characters are accepted, no other characters are allowed.</p>						

## Example

```
__var number;
if (__readFile(myFileHandle, &number) == 0)
{
    // Do something with number
}
```

In this example, if the file pointed to by `myFileHandle` contains the ASCII characters 1234 abcd 90ef, consecutive reads will assign the values 0x1234 0xabcd 0x90ef to the variable `number`.

**\_\_readFileByte**

## Syntax

```
__readFileByte(fileHandle)
```

## Parameters

*fileHandle*

A macro variable used as filehandle by the `__openFile` macro.

## Return value

-1 upon error or end-of-file, otherwise a value between 0 and 255.

## For use with

All C-SPY drivers.

## Description

Reads one byte from a file.

## Example

```
__var byte;
while ( (byte = __readFileByte(myFileHandle)) != -1 )
{
    /* Do something with byte */
}
```

**\_\_readMemory8, \_\_readMemoryByte**

## Syntax

```
__readMemory8(address, zone)
__readMemoryByte(address, zone)
```

## Parameters

*address*

The memory address (integer).

*zone*

A string that specifies the memory zone, see *C-SPY memory zones*, page 128.

## Return value

The macro returns the value from memory.

## For use with

All C-SPY drivers.

Description Reads one byte from a given memory location.

Example `__readMemory8(0x0108, "");`

## **\_\_readMemory16**

Syntax `__readMemory16(address, zone)`

Parameters

*address*

The memory address (integer).

*zone*

A string that specifies the memory zone, see *C-SPY memory zones*, page 128.

Return value The macro returns the value from memory.

For use with All C-SPY drivers.

Description Reads a two-byte word from a given memory location.

Example `__readMemory16(0x0108, "");`

## **\_\_readMemory32**

Syntax `__readMemory32(address, zone)`

Parameters

*address*

The memory address (integer).

*zone*

A string that specifies the memory zone, see *C-SPY memory zones*, page 128.

Return value The macro returns the value from memory.

For use with All C-SPY drivers.

Description Reads a four-byte word from a given memory location.

Example `__readMemory32(0x0108, "");`

**\_\_registerMacroFile**

Syntax	<code>__registerMacroFile(<i>filename</i>)</code>
Parameters	<i>filename</i> A file containing the macros to be registered (string). The filename must include a path, which must either be absolute or use argument variables. For information about argument variables, see the <i>IDE Project Management and Building Guide for STM8</i> .
Return value	int 0
For use with	All C-SPY drivers.
Description	Registers macros from a setup macro file. With this function you can register multiple macro files during C-SPY startup.
Example	<code>__registerMacroFile("c:\\testdir\\macro.mac");</code>
See also	<i>Using C-SPY macros</i> , page 255.

**\_\_resetFile**

Syntax	<code>__resetFile(<i>fileHandle</i>)</code>
Parameters	<i>fileHandle</i> A macro variable used as filehandle by the <code>__openFile</code> macro.
Return value	int 0
For use with	All C-SPY drivers.
Description	Rewinds a file previously opened by <code>__openFile</code> .

## \_\_setCodeBreak

### Syntax

```
__setCodeBreak(location, count, condition, cond_type, action)
```

### Parameters

*location*

A string that defines the code location of the breakpoint, either a valid C-SPY expression whose value evaluates to a valid address, an absolute location, or a source location. For more information about the location types, see *Enter Location dialog box*, page 124.

*count*

The number of times that a breakpoint condition must be fulfilled before a break occurs (integer).

*condition*

The breakpoint condition (string).

*cond\_type*

The condition type; either "CHANGED" or "TRUE" (string).

*action*

An expression, typically a call to a macro, which is evaluated when the breakpoint is detected.

### Return value

Result	Value
Successful	An unsigned integer uniquely identifying the breakpoint. This value must be used to clear the breakpoint.
Unsuccessful	0

Table 26: \_\_setCodeBreak return values

### For use with

The C-SPY hardware debugger drivers.

### Description

Sets a code breakpoint, that is, a breakpoint which is triggered just before the processor fetches an instruction at the specified location.

### Examples

```
__setCodeBreak("{D:\\src\\prog.c}.12.9", 3, "d>16", "TRUE",
"ActionCode()");
```

This example sets a code breakpoint on the label `main` in your source:

```
__setCodeBreak("main", 0, "1", "TRUE", "");
```

### See also

*Breakpoints*, page 101.

## \_\_setDataBreak

Syntax	<code>__setDataBreak(location, count, condition, cond_type, access, action)</code>							
Parameters	<i>location</i>	A string that defines the data location of the breakpoint, either a valid C-SPY expression whose value evaluates to a valid address or an absolute location. For more information about the location types, see Enter Location dialog box, page 25.						
	<i>count</i>	The number of times that a breakpoint condition must be fulfilled before a break occurs (integer).						
	<i>condition</i>	The breakpoint condition (string).						
	<i>cond_type</i>	The condition type; either "CHANGED" or "TRUE" (string).						
	<i>access</i>	The memory access type: "R", for read, "W" for write, or "RW" for read/write.						
	<i>action</i>	An expression, typically a call to a macro, which is evaluated when the breakpoint is detected.						
Return value	<table border="1"> <thead> <tr> <th>Result</th> <th>Value</th> </tr> </thead> <tbody> <tr> <td>Successful</td> <td>An unsigned integer uniquely identifying the breakpoint. This value must be used to clear the breakpoint.</td> </tr> <tr> <td>Unsuccessful</td> <td>0</td> </tr> </tbody> </table>		Result	Value	Successful	An unsigned integer uniquely identifying the breakpoint. This value must be used to clear the breakpoint.	Unsuccessful	0
Result	Value							
Successful	An unsigned integer uniquely identifying the breakpoint. This value must be used to clear the breakpoint.							
Unsuccessful	0							
For use with	The C-SPY ST-LINK driver							
	The C-SPY STice driver, using SWIM mode.							
Description	Sets a data breakpoint, that is, a breakpoint which is triggered directly after the processor has read or written data at the specified location.							

Table 27: \_\_setDataBreak return values



## Example

```
__var brk;
brk = __setDataBreak(":0x4710", 3, "d>6", "TRUE",
    "W", "ActionData()");
...
__clearBreak(brk);
```

## See also

*Breakpoints*, page 101.

## \_\_setDataLogBreak

## Syntax

```
__setDataLogBreak(variable, access)
```

## Parameters

*variable*

A string that defines the variable the breakpoint is set on, a variable of integer type with static storage duration. The microcontroller must also be able to access the variable with a single-instruction memory access, which means that you can only set data log breakpoints on 8- and 16-bit variables.

*access*

The memory access type: "R", for read, "W" for write, or "RW" for read/write.

## Return value

Result	Value
Successful	An unsigned integer uniquely identifying the breakpoint. This value must be used to clear the breakpoint.
Unsuccessful	0

Table 28: *\_\_setDataLogBreak* return values

## For use with

The C-SPY Simulator.

## Description

Sets a data log breakpoint, that is, a breakpoint which is triggered when a specified variable is accessed. Note that a data log breakpoint does not stop the execution, it just generates a data log.

## Example

```
__var brk;
brk = __setDataLogBreak("MyVar", "R");
...
__clearBreak(brk);
```

## See also

*Breakpoints*, page 101 and *Getting started using data logging*, page 187.

## \_\_setLogBreak

### Syntax

```
__setLogBreak(location, message, msg_type, condition,
              cond_type)
```

### Parameters

*location*

A string that defines the code location of the breakpoint, either a valid C-SPY expression whose value evaluates to a valid address, an absolute location, or a source location. For more information about the location types, see *Enter Location dialog box*, page 124.

*message*

The message text.

*msg\_type*

The message type; choose between:

TEXT, the message is written word for word.

ARGS, the message is interpreted as a comma-separated list of C-SPY expressions or strings.

*condition*

The breakpoint condition (string).

*cond\_type*

The condition type; either "CHANGED" or "TRUE" (string).

### Return value

Result	Value
Successful	An unsigned integer uniquely identifying the breakpoint. The same value must be used when you want to clear the breakpoint.
Unsuccessful	0

Table 29: \_\_setLogBreak return values

### For use with

The C-SPY Simulator

### Description

Sets a log breakpoint, that is, a breakpoint which is triggered when an instruction is fetched from the specified location. If you have set the breakpoint on a specific machine instruction, the breakpoint will be triggered and the execution will temporarily halt and print the specified message in the C-SPY **Debug Log** window.

## Example

```

__var logBp1;
__var logBp2;

logOn()
{
    logBp1 = __setLogBreak ("{C:\\temp\\Utilities.c}.23.1",
        "\\Entering trace zone at :\\", #PC:%X", "ARGS", "1", "TRUE");
    logBp2 = __setLogBreak ("{C:\\temp\\Utilities.c}.30.1",
        "Leaving trace zone...", "TEXT", "1", "TRUE");
}

logOff()
{
    __clearBreak(logBp1);
    __clearBreak(logBp2);
}

```

## See also

*Formatted output*, page 263 and *Breakpoints*, page 101.

**\_\_setSimBreak**

## Syntax

```
__setSimBreak(location, access, action)
```

## Parameters

*location*

A string that defines the data location of the breakpoint, either a valid C-SPY expression whose value evaluates to a valid address or an absolute location. For more information about the location types, see *Enter Location dialog box*, page 124.

*access*

The memory access type: "R" for read or "W" for write.

*action*

An expression, typically a call to a macro, which is evaluated when the breakpoint is detected.

## Return value

Result	Value
Successful	An unsigned integer uniquely identifying the breakpoint. This value must be used to clear the breakpoint.
Unsuccessful	0

Table 30: *\_\_setSimBreak* return values

## For use with

The C-SPY Simulator.

**Description** Use this system macro to set *immediate* breakpoints, which will halt instruction execution only temporarily. This allows a C-SPY macro function to be called when the processor is about to read data from a location or immediately after it has written data. Instruction execution will resume after the action.

This type of breakpoint is useful for simulating memory-mapped devices of various kinds (for instance serial ports and timers). When the processor reads at a memory-mapped location, a C-SPY macro function can intervene and supply the appropriate data. Conversely, when the processor writes to a memory-mapped location, a C-SPY macro function can act on the value that was written.

## \_\_setTraceStartBreak

**Syntax** `__setTraceStartBreak(location)`

**Parameters** *location*

A string that defines the code location of the breakpoint, either a valid C-SPY expression whose value evaluates to a valid address, an absolute location, or a source location. For more information about the location types, see *Enter Location dialog box*, page 124.

**Return value**

Result	Value
Successful	An unsigned integer uniquely identifying the breakpoint. The same value must be used when you want to clear the breakpoint.
Unsuccessful	0

Table 31: \_\_setTraceStartBreak return values

**For use with** The C-SPY Simulator.

**Description** Sets a breakpoint at the specified location. When that breakpoint is triggered, the trace system is started.

## Example

```

__var startTraceBp;
__var stopTraceBp;

traceOn()
{
    startTraceBp = __setTraceStartBreak
        ("C:\\TEMP\\Utilities.c).23.1");
    stopTraceBp = __setTraceStopBreak
        ("C:\\temp\\Utilities.c).30.1");
}

traceOff()
{
    __clearBreak(startTraceBp);
    __clearBreak(stopTraceBp);
}

```

## See also

*Breakpoints*, page 101.

## \_\_setTraceStopBreak

## Syntax

```
__setTraceStopBreak(location)
```

## Parameters

*location*

A string that defines the code location of the breakpoint, either a valid C-SPY expression whose value evaluates to a valid address, an absolute location, or a source location. For more information about the location types, see *Enter Location dialog box*, page 124.

## Return value

Result	Value
Successful	An unsigned integer uniquely identifying the breakpoint. The same value must be used when you want to clear the breakpoint.
Unsuccessful	int 0

Table 32: *\_\_setTraceStopBreak* return values

## For use with

The C-SPY Simulator.

## Description

Sets a breakpoint at the specified location. When that breakpoint is triggered, the trace system is stopped.

## Example

See *\_\_setTraceStartBreak*, page 292.

See also *Breakpoints*, page 101.

## **\_\_sourcePosition**

Syntax `__sourcePosition(linePtr, colPtr)`

Parameters

*linePtr*  
Pointer to the variable storing the line number

*colPtr*  
Pointer to the variable storing the column number

Return value

Result	Value
Successful	Filename string
Unsuccessful	Empty ( " " ) string

Table 33: *\_\_sourcePosition* return values

For use with All C-SPY drivers.

Description If the current execution location corresponds to a source location, this macro returns the filename as a string. It also sets the value of the variables, pointed to by the parameters, to the line and column numbers of the source location.

## **\_\_strFind**

Syntax `__strFind(macroString, pattern, position)`

Parameters

*macroString*  
A macro string.

*pattern*  
The string pattern to search for

*position*  
The position where to start the search. The first position is 0

Return value The position where the pattern was found or -1 if the string is not found.

For use with All C-SPY drivers.

Description	This macro searches a given string ( <i>macroString</i> ) for the occurrence of another string ( <i>pattern</i> ).
Example	<pre>__strFind("Compiler", "pile", 0) = 3 __strFind("Compiler", "foo", 0) = -1</pre>
See also	<i>Macro strings</i> , page 261.

## \_\_subString

Syntax	<code>__subString(<i>macroString</i>, <i>position</i>, <i>length</i>)</code>
Parameters	<p><i>macroString</i> A macro string.</p> <p><i>position</i> The start position of the substring. The first position is 0.</p> <p><i>length</i> The length of the substring</p>
Return value	A substring extracted from the given macro string.
For use with	All C-SPY drivers.
Description	This macro extracts a substring from another string ( <i>macroString</i> ).
Example	<pre>__subString("Compiler", 0, 2) The resulting macro string contains Co. __subString("Compiler", 3, 4) The resulting macro string contains pile.</pre>
See also	<i>Macro strings</i> , page 261.

## \_\_targetDebuggerVersion

Syntax	<code>__targetDebuggerVersion()</code>
Return value	A string that represents the version number of the C-SPY debugger processor module.
For use with	All C-SPY drivers.

Description This macro returns the version number of the C-SPY debugger processor module.

Example

```
__var toolVer;
toolVer = __targetDebuggerVersion();
__message "The target debugger version is, ", toolVer;
```

## **\_\_toLower**

Syntax `__toLower(macroString)`

Parameters *macroString*

A macro string.

Return value The converted macro string.

For use with All C-SPY drivers.

Description This macro returns a copy of the parameter *macroString* where all the characters have been converted to lower case.

Example

```
__toLower("IAR")
The resulting macro string contains iar.
__toLower("Mix42")
The resulting macro string contains mix42.
```

See also *Macro strings*, page 261.

## **\_\_toString**

Syntax `__toString(C_string, maxlength)`

Parameters *C\_string*

Any null-terminated C string.

*maxlength*

The maximum length of the returned macro string.

Return value Macro string.

For use with All C-SPY drivers.



Description	This macro is used for converting C strings ( <code>char*</code> or <code>char []</code> ) into macro strings.
Example	Assuming your application contains this definition: <pre>char const * hptr = "Hello World!";</pre> this macro call: <pre>__toString(hptr, 5)</pre> would return the macro string containing <code>Hello</code> .
See also	<i>Macro strings</i> , page 261.

## **\_\_ToUpper**

Syntax	<code>__ToUpper(<i>macroString</i>)</code>
Parameters	<i>macroString</i> A macro string.
Return value	The converted string.
For use with	All C-SPY drivers.
Description	This macro returns a copy of the parameter <i>macroString</i> where all the characters have been converted to upper case.
Example	<pre>__ToUpper("string")</pre> The resulting macro string contains <code>STRING</code> .
See also	<i>Macro strings</i> , page 261.

## **\_\_unloadImage**

Syntax	<code>__unloadImage(<i>module_id</i>)</code>
Parameters	<i>module_id</i> An integer which represents a unique module identification, which is retrieved as a return value from the corresponding <code>__loadImage</code> C-SPY macro.

Return value

Value	Result
<i>module_id</i>	A unique module identification (the same as the input parameter).
int 0	The unloading failed.

Table 34: *\_\_unloadImage* return values

For use with

All C-SPY drivers.

Description

Unloads debug information from an already downloaded image.

See also

*Loading multiple images*, page 41 and *Images*, page 325.

## **\_\_writeFile**

Syntax

`__writeFile(fileHandle, value)`

Parameters

*fileHandle*A macro variable used as filehandle by the `__openFile` macro.*value*

An integer.

Return value

int 0

For use with

All C-SPY drivers.

Description

Prints the integer value in hexadecimal format (with a trailing space) to the file *file*.**Note:** The `__fmessage` statement can do the same thing. The `__writeFile` macro is provided for symmetry with `__readFile`.

## **\_\_writeFileByte**

Syntax

`__writeFileByte(fileHandle, value)`

Parameters

*fileHandle*A macro variable used as filehandle by the `__openFile` macro.*value*

An integer.

Return value	<code>int 0</code>
For use with	All C-SPY drivers.
Description	Writes one byte to the file <i>fileHandle</i> .

## **\_\_writeMemory8, \_\_writeMemoryByte**

Syntax	<code>__writeMemory8(value, address, zone)</code> <code>__writeMemoryByte(value, address, zone)</code>
Parameters	<p><i>value</i> An integer.</p> <p><i>address</i> The memory address (integer).</p> <p><i>zone</i> A string that specifies the memory zone, see <i>C-SPY memory zones</i>, page 128.</p>
Return value	<code>int 0</code>
For use with	All C-SPY drivers.
Description	Writes one byte to a given memory location.
Example	<code>__writeMemory8(0x2F, 0x8020, "");</code>

## **\_\_writeMemory16**

Syntax	<code>__writeMemory16(value, address, zone)</code>
Parameters	<p><i>value</i> An integer.</p> <p><i>address</i> The memory address (integer).</p> <p><i>zone</i> A string that specifies the memory zone, see <i>C-SPY memory zones</i>, page 128.</p>
Return value	<code>int 0</code>

For use with	All C-SPY drivers.
Description	Writes two bytes to a given memory location.
Example	<code>__writeMemory16(0x2FFF, 0x8020, "");</code>

## **\_\_writeMemory32**

Syntax	<code>__writeMemory32(value, address, zone)</code>
Parameters	<p><i>value</i> An integer.</p> <p><i>address</i> The memory address (integer).</p> <p><i>zone</i> A string that specifies the memory zone, see <i>C-SPY memory zones</i>, page 128.</p>
Return value	<code>int 0</code>
For use with	All C-SPY drivers.
Description	Writes four bytes to a given memory location.
Example	<code>__writeMemory32(0x5555FFFF, 0x8020, "");</code>

---

## **Graphical environment for macros**

Reference information about:

- *Macro Registration window*, page 301
- *Debugger Macros window*, page 303
- *Macro Quicklaunch window*, page 305

## Macro Registration window

The **Macro Registration** window is available from the **View>Macros** submenu during a debug session.

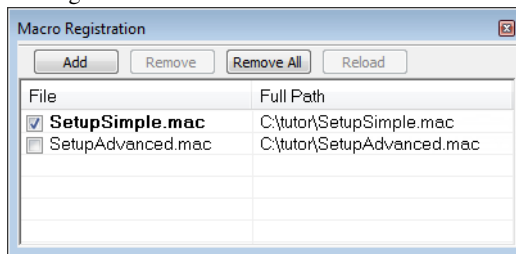

Use this window to list, register, and edit your debugger macro files.

Double-click a macro file to open it in the editor window and edit it.

See also *Registering C-SPY macros—an overview*, page 256.

### Requirements

None; this window is always available.

### Display area

This area contains these columns:

#### File

The name of an available macro file. To register the macro file, select the check box to the left of the filename. The name of a registered macro file appears in bold style.

#### Full path

The path to the location of the added macro file.

## Context menu

This context menu is available:

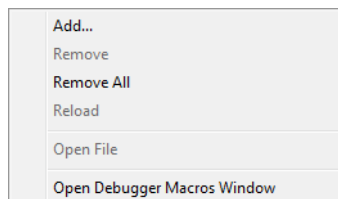

These commands are available:

### Add

Opens a file browser where you can locate the macro file that you want to add to the list. This menu command is also available as a function button at the top of the window.

### Remove

Removes the selected debugger macro file from the list. This menu command is also available as a function button at the top of the window.

### Remove All

Removes all macro files from the list. This menu command is also available as a function button at the top of the window.

### Reload

Registers the selected macro file. Typically, this is useful when you have edited a macro file. This menu command is also available as a function button at the top of the window.

### Open File

Opens the selected macro file in the editor window.

### Open Debugger Macros Window

Opens the **Debugger Macros** window.

## Debugger Macros window

The **Debugger Macros** window is available from the **View>Macros** submenu during a debug session.

Click the **Name** header or the **File** header to sort alphabetically on either function name or filename.

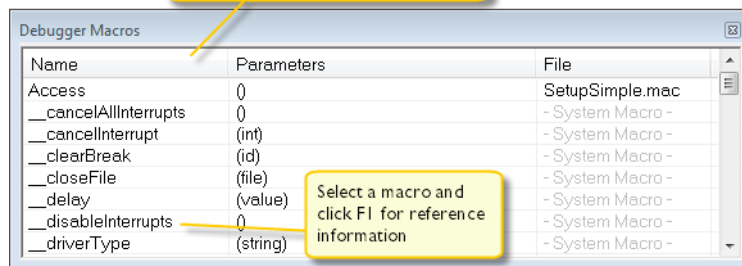

Use this window to list all registered debugger macro functions, either predefined system macros or your own. This window is useful when you edit your own macro functions and want an overview of all available macros that you can use.

- Click the column headers **Name** or **File** to sort alphabetically on either function name or filename.
- Double-clicking a macro defined in a file opens that file in the editor window.
- To open a macro in the **Macro Quicklaunch** window, drag it from the **Debugger Macros** window and drop it in the **Macro Quicklaunch** window.
- Select a macro and press F1 to get online help information for that macro.

### Requirements

None; this window is always available.

### Display area

This area contains these columns:

#### Name

The name of the debugger macro.

#### Parameters

The parameters of the debugger macro.

#### File

For macros defined in a file, the name of the file is displayed. For predefined system macros, -System Macro- is displayed.

## Context menu

This context menu is available:

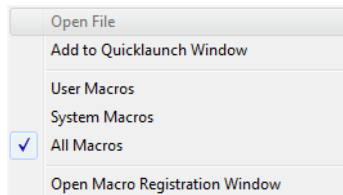

These commands are available:

### **Open File**

Opens the selected debugger macro file in the editor window.

### **Add to Quicklaunch Window**

Adds the selected macro to the **Macro Quicklaunch** window.

### **User Macros**

Lists only the debugger macros that you have defined yourself.

### **System Macros**

Lists only the predefined system macros.

### **All Macros**

Lists all debugger macros, both predefined system macros and your own.

### **Open Macro Registration Window**

Opens the **Macro Registration** window.



## Macro Quicklaunch window

The **Macro Quicklaunch** window is available from the **View** menu.

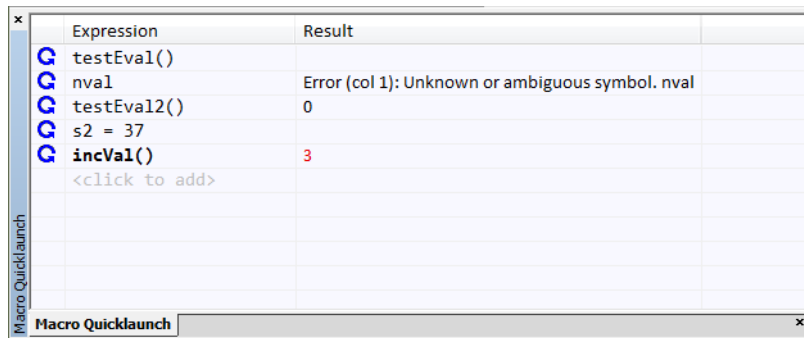

Use this window to evaluate expressions, typically C-SPY macros.

For some devices, there are predefined C-SPY macros available with device support, typically provided by the chip manufacturer. These macros are useful for performing certain device-specific tasks. The macros are available in the **Macro Quicklaunch** window and are easily identified by their green icon,

The **Macro Quicklaunch** window is similar to the **Quick Watch** window, but is primarily designed for evaluating C-SPY macros. The window gives you precise control over when to evaluate an expression.

See also *Executing C-SPY macros—an overview*, page 256.

### To add an expression:

- I Choose one of these alternatives:
  - Drag the expression to the window
  - In the **Expression** column, type the expression you want to examine.

If the expression you add and want to evaluate is a C-SPY macro, the macro must first be registered, see *Registering C-SPY macros—an overview*, page 256.

### To evaluate an expression:



- I Double-click the **Recalculate** icon to calculate the value of that expression.

### Requirements

None; this window is always available.

## Display area

This area contains these columns:



### Recalculate icon

To evaluate the expression, double-click the icon. The latest evaluated expression appears in bold style.

### Expression

One or several expressions that you want to evaluate. Click <click to add> to add an expression. If the return value has changed since last time, the value will be displayed in red.

### Result

Shows the return value from the expression evaluation.

## Context menu

This context menu is available:

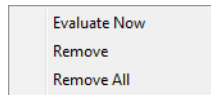

These commands are available:

### Evaluate Now

Evaluates the selected expression.

### Remove

Removes the selected expression.

### Remove All

Removes all selected expressions.

# The C-SPY command line utility—`cspybat`

- Using C-SPY in batch mode
- Summary of C-SPY command line options
- Reference information on C-SPY command line options.

---

## Using C-SPY in batch mode

You can execute C-SPY in batch mode if you use the command line utility `cspybat`, installed in the directory `common\bin`.

These topics are covered:

- Starting `cspybat`
- Output
- Invocation syntax

### STARTING CSPYBAT

- 1 To start `cspybat` you must first create a batch file. An easy way to do that is to use one of the batch files that C-SPY automatically generates when you start C-SPY in the IDE.

C-SPY generates a batch file `projectname.buildconfiguration.cspy.bat` every time C-SPY is initialized. In addition, two more files are generated:

- `project.buildconfiguration.general.xml`, which contains options specific to `cspybat`.
- `project.buildconfiguration.driver.xml`, which contains options specific to the C-SPY driver you are using.

You can find the files in the directory `$PROJ_DIR$\settings`. The files contain the same settings as the IDE, and provide hints about additional options that you can use.

- 2 To start `cspybat`, you can use this command line:

```
project.cspybat.bat [debugfile]
```

Note that *debugfile* is optional. You can specify it if you want to use a different debug file than the one that is used in the *project.buildconfiguration.general.xml* file.

## OUTPUT

When you run `cspybat`, these types of output can be produced:

- Terminal output from `cspybat` itself
 

All such terminal output is directed to `stderr`. Note that if you run `cspybat` from the command line without any arguments, the `cspybat` version number and all available options including brief descriptions are directed to `stdout` and displayed on your screen.
- Terminal output from the application you are debugging
 

All such terminal output is directed to `stdout`, provided that you have used the `--plugin` option. See *--plugin*, page 317.
- Error return codes
 

`cspybat` returns status information to the host operating system that can be tested in a batch file. For *successful*, the value `int 0` is returned, and for *unsuccessful* the value `int 1` is returned.

## INVOCATION SYNTAX

The invocation syntax for `cspybat` is:

```
cspybat processor_DLL driver_DLL debug_file
        [cspybat_options] --backend driver_options
```

**Note:** In those cases where a filename is required—including the DLL files—you are recommended to give a full path to the filename.

## Parameters

The parameters are:

Parameter	Description
<i>processor_DLL</i>	The processor-specific DLL file; available in <code>stm8\bin</code> .
<i>driver_DLL</i>	The C-SPY driver DLL file; available in <code>stm8\bin</code> .
<i>debug_file</i>	The object file that you want to debug (filename extension <code>dnn</code> ). See also <i>--debugfile</i> , page 312.
<i>cspybat_options</i>	The command line options that you want to pass to <code>cspybat</code> . Note that these options are optional. For information about each option, see <i>Reference information on C-SPY command line options</i> , page 310.

Table 35: *cspybat* parameters

Parameter	Description
<code>--backend</code>	Marks the beginning of the parameters to the C-SPY driver; all options that follow will be sent to the driver. Note that this option is mandatory.
<code>driver_options</code>	The command line options that you want to pass to the C-SPY driver. Note that some of these options are mandatory and some are optional. For information about each option, see <i>Reference information on C-SPY command line options</i> , page 310.

Table 35: cspybat parameters (Continued)

## Summary of C-SPY command line options

Reference information about:

- General cspybat options
- Options available for all C-SPY drivers
- Options available for the simulator driver
- Options available for the C-SPY hardware drivers
- Options available for the C-SPY STice driver

### GENERAL CSPYBAT OPTIONS

<code>--attach_to_running_target</code>	Makes the debugger attach to a running application at its current location, without resetting the target system.
<code>--backend</code>	Marks the beginning of the parameters to be sent to the C-SPY driver (mandatory).
<code>--code_coverage_file</code>	Enables the generation of code coverage information and places it in a specified file.
<code>--cycles</code>	Specifies the maximum number of cycles to run.
<code>--debugfile</code>	Specifies an alternative debug file.
<code>--download_only</code>	Downloads a code image without starting a debug session afterwards.
<code>-f</code>	Extends the command line.
<code>--leave_target_running</code>	Makes the debugger leave the application running on the target hardware after the debug session is closed.
<code>--macro</code>	Specifies a macro file to be used.

<code>--macro_param</code>	Assigns a value to a C-SPY macro parameter.
<code>--plugin</code>	Specifies a plugin file to be used.
<code>--silent</code>	Omits the sign-on message.
<code>--timeout</code>	Limits the maximum allowed execution time.

### OPTIONS AVAILABLE FOR ALL C-SPY DRIVERS

<code>-p</code>	Specifies the device description file to be used.
-----------------	---

### OPTIONS AVAILABLE FOR THE SIMULATOR DRIVER

<code>--disable_interrupts</code>	Disables the interrupt simulation.
<code>--mapu</code>	Activates memory access checking.

### OPTIONS AVAILABLE FOR THE C-SPY HARDWARE DRIVERS

<code>--erase_memory</code>	Erases the memory before downloading the code.
<code>--log_file</code>	Creates a log file.
<code>--mcuname</code>	Specifies the name of the MCU used for debugging.
<code>--suppress_download</code>	Suppresses download of the executable image.
<code>--verify_download</code>	Verifies the executable image.

### OPTIONS AVAILABLE FOR THE C-SPY STICE DRIVER

<code>--swim</code>	Enables the SWIM interface.
---------------------	-----------------------------

---

## Reference information on C-SPY command line options

This section gives detailed reference information about each `cspybat` option and each option available to the C-SPY drivers.

### **--attach\_to\_running\_target**

Syntax

`--attach_to_running_target`

For use with	<code>cspybat</code> .
	<b>Note:</b> This option might not be supported by the combination of C-SPY driver and device that you are using. If you are using this option with an unsupported combination, C-SPY produces a message.
Description	Use this option to make the debugger attach to a running application at its current location, without resetting the target system.  If you have defined any breakpoints in your project, the C-SPY driver will set them during attachment. If the C-SPY driver cannot set them without stopping the target system, the breakpoints will be disabled. The option also suppresses download and the <b>Run to</b> option.



### Project>Attach to Running Target

## --backend

Syntax	<code>--backend {driver options}</code>
Parameters	<i>driver options</i> Any option available to the C-SPY driver you are using.
For use with	<code>cspybat</code> (mandatory).
Description	Use this option to send options to the C-SPY driver. All options that follow <code>--backend</code> will be passed to the C-SPY driver, and will not be processed by <code>cspybat</code> itself.



This option is not available in the IDE.

## --code\_coverage\_file

Syntax	<code>--code_coverage_file file</code>
	Note that this option must be placed before the <code>--backend</code> option on the command line.
Parameters	<i>file</i> The name of the destination file for the code coverage information.
For use with	<code>cspybat</code>

**Description** Use this option to enable the generation of a text-based report file for code coverage information. The code coverage information will be generated after the execution has completed and you can find it in the specified file. Because most embedded applications do not terminate, you might have to use this option in combination with `--timeout` or `--cycles`.

Note that this option requires that the C-SPY driver you are using supports code coverage. If you try to use this option with a C-SPY driver that does not support code coverage, an error message will be directed to `stderr`.

**See also** *Code coverage*, page 221, `--cycles`, page 312, `--timeout`, page 319.



To set this option, choose **View>Code Coverage**, right-click and choose **Save As** when the C-SPY debugger is running.

## --cycles

**Syntax** `--cycles cycles`

Note that this option must be placed before the `--backend` option on the command line.

**Parameters** *cycles*

The number of cycles to run.

**For use with** `cspybat`

**Description** Use this option to specify the maximum number of cycles to run. If the target program executes longer than the number of cycles specified, the target program will be aborted. Using this option requires that the C-SPY driver you are using supports a cycle counter, and that it can be sampled while executing.



This option is not available in the IDE.

## --debugfile

**Syntax** `--debugfile filename`

**Parameters** *filename*

The name of the debug file to use.

**For use with** `cspybat`



Description	<p>This option can be placed both before and after the <code>--backend</code> option on the command line.</p> <p>Use this option to make <code>cspybat</code> use the specified debugfile instead of the one used in the generated <code>cpsybat.bat</code> file.</p> <p> This option is not available in the IDE.</p>
-------------	---

## --disable\_interrupts

Syntax	<code>--disable_interrupts</code>
For use with	The C-SPY Simulator driver.
Description	<p>Use this option to disable the interrupt simulation.</p> <p> To set this option, choose <b>Simulator&gt;Interrupt Setup</b> and deselect the <b>Enable interrupt simulation</b> option.</p>

## --download\_only

Syntax	<code>--download_only</code>
For use with	<code>cspybat</code>
Description	<p>Use this option to download the code image without starting a debug session afterwards.</p> <p> To set a related option, choose: <b>Project&gt;Options&gt;Debugger&gt;Setup</b> and deselect <b>Run to</b>.</p>

## --erase\_memory

Syntax	<code>--erase_memory</code>
For use with	Any C-SPY hardware debugger driver.
Description	Erases the memory (FLASH, EEPROM, and option bytes) before downloading the code. This is done by first setting the Read-Out Protection option byte and then clearing

it (or the other way around if ROP is already set). During the clearing phase, all memory areas are erased.

This option is only available for supported devices and when using STice in SWIM mode or ST-LINK.



**Project>Options>Debugger>Driver>Setup>Erase**

## **-f**



Syntax	<code>-f filename</code>
Parameters	<p><i>filename</i></p> <p>A text file that contains the command line options (default filename extension <code>xcl</code>).</p>
For use with	<p><code>cspybat</code></p> <p>This option can be placed either before or after the <code>--backend</code> option on the command line.</p>
Description	<p>Use this option to make <code>cspybat</code> read command line options from the specified file.</p> <p>In the command file, you format the items exactly as if they were on the command line itself, except that you may use multiple lines, because the newline character is treated like a space or tab character.</p> <p>Both C/C++ style comments are allowed in the file. Double quotes behave in the same way as in the Microsoft Windows command line environment.</p>



To set this option, use **Project>Options>Debugger>Extra Options**.

## **--leave\_target\_running**

Syntax	<code>--leave_target_running</code>
For use with	<p><code>cspybat</code>.</p> <p>For any of these C-SPY drivers:</p> <ul style="list-style-type: none"> <li>● The C-SPY ST-LINK driver</li> <li>● The C-SPY STice driver (in non-SWIM mode)</li> </ul>

Description	<p><b>Note:</b> Even if this option is supported by the C-SPY driver you are using, there might be device-specific limitations.</p> <p>Use this option to make the debugger leave the application running on the target hardware after the debug session is closed.</p> <p><b>Note:</b> This option only has effect when you have selected <b>Project&gt;Attach to Running Target</b>.</p> <p> Any existing breakpoints will not be automatically removed. You might want to consider disabling all breakpoints before using this option.</p> <p> <b>C-SPY driver&gt;Leave Target Running</b></p>
-------------	---

## --log\_file

Syntax	<code>--log_file=filename</code>
Parameters	<p><i>filename</i></p> <p>The name of the log file.</p>
For use with	Any C-SPY hardware debugger driver.
Description	<p>Use this option to log the communication between C-SPY and the target system to a file. To interpret the result, detailed knowledge of the communication protocol is required.</p> <p> <b>Project&gt;Options&gt;Debugger&gt;Driver&gt;Communication Log</b></p>

## --macro

Syntax	<code>--macro filename</code>
Parameters	<p><i>filename</i></p> <p>The C-SPY macro file to be used (filename extension <code>mac</code>).</p>
For use with	<code>cspybat</code>
Description	Use this option to specify a C-SPY macro file to be loaded before executing the target application. This option can be used more than once on the command line.

See also

*Briefly about using C-SPY macros, page 254.***Project>Options>Debugger>Setup>Setup macros>Use macro file**

## --macro\_param

Syntax

`--macro_param [param=value]`Note that this option must be placed before the `--backend` option on the command line.

Parameters

*param = value**param* is a parameter defined using the `__param` C-SPY macro construction.  
*value* is a value.

For use with

`cspybat`

Description

Use this option to assign a value to a C-SPY macro parameter. This option can be used more than once on the command line.

See also

*Macro parameters, page 261.***Project>Options>Debugger>Extra Options**

## --mapu

Syntax

`--mapu`

For use with

The C-SPY simulator driver.

Description

Specify this option to use the section information in the debug file for memory access checking. During the execution, the simulator will then check for accesses to unspecified memory ranges. If any such access is found, the C function call stack and a message will be printed on `stderr` and the execution will stop.

See also

*Monitoring memory and registers, page 130.*

To set related options, choose:

**Simulator>Memory Access Setup**

**--mcuname**

Syntax	<code>--mcuname <i>name</i></code>
Parameters	<i>name</i> The name of the MCU used for debugging, for example STM8S208MB.
For use with	Any C-SPY hardware debugger driver.
Description	Use this option to specify the name of the MCU used for debugging. This option is mandatory, to be able to communicate with the hardware.



**Project>Options>General Options>Target>Device**

**-p**

Syntax	<code>-p <i>filename</i></code>
Parameters	<i>filename</i> The device description file to be used.
For use with	All C-SPY drivers.
Description	Use this option to specify the device description file to be used.
See also	<i>Selecting a device description file</i> , page 38.



**Project>Options>Debugger>Setup>Device description file**

**--plugin**

Syntax	<code>--plugin <i>filename</i></code> Note that this option must be placed before the <code>--backend</code> option on the command line.
Parameters	<i>filename</i> The plugin file to be used (filename extension <code>dll</code> ).
For use with	<code>cspybat</code>

**Description** Certain C/C++ standard library functions, for example `printf`, can be supported by C-SPY—for example, the C-SPY **Terminal I/O** window—instead of by real hardware devices. To enable such support in `cspybat`, a dedicated plugin module called `stm8bat.dll` located in the `stm8\bin` directory must be used.

Use this option to include this plugin during the debug session. This option can be used more than once on the command line.

**Note:** You can use this option to include also other plugin modules, but in that case the module must be able to work with `cspybat` specifically. This means that the C-SPY plugin modules located in the `common\plugin` directory cannot normally be used with `cspybat`.



**Project>Options>Debugger>Plugins**

## --silent

**Syntax** `--silent`

Note that this option must be placed before the `--backend` option on the command line.

**For use with** `cspybat`

**Description** Use this option to omit the sign-on message.



This option is not available in the IDE.

## --suppress\_download

**Syntax** `--suppress_download`

**For use with** Any C-SPY hardware debugger driver.

**Description** Use this option to suppress the downloading of the executable image to a non-volatile type of target memory. The image corresponding to the debugged application must already exist in the target.

If this option is combined with the option `--verify_download`, the debugger will read back the executable image from memory and verify that it is identical to the debugged application.



**Project>Options>Debugger>Setup>Download>Suppress**

**--swim**

Syntax	--swim
For use with	The C-SPY STice driver.
Description	Use this option to enable the SWIM interface.
	 <b>Project&gt;Options&gt;Debugger&gt;STice&gt;Setup&gt;Use SWIM interface</b>

**--timeout**

Syntax	--timeout <i>milliseconds</i>
	Note that this option must be placed before the --backend option on the command line.
Parameters	<i>milliseconds</i> The number of milliseconds before the execution stops.
For use with	cspybat
Description	Use this option to limit the maximum allowed execution time.
	 This option is not available in the IDE.

**--verify\_download**

Syntax	--verify_download
For use with	Any C-SPY hardware debugger driver.
Description	Use this option to verify that the downloaded code image can be read back from target memory with the correct contents.
	 <b>Project&gt;Options&gt;Debugger&gt;Driver&gt;Verify download</b>





# Part 4. Additional reference information

This part of the *C-SPY® Debugging Guide for STM8* includes these chapters:

- Debugger options
- Additional information on C-SPY drivers

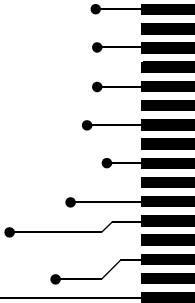



# Debugger options

- Setting debugger options
- Reference information on general debugger options
- Reference information on C-SPY hardware debugger driver options

---

## Setting debugger options

Before you start the C-SPY debugger you might need to set some options—both C-SPY generic options and options required for the target system (C-SPY driver-specific options).

### To set debugger options in the IDE:

- 1 Choose **Project>Options** to display the **Options** dialog box.
- 2 Select **Debugger** in the **Category** list.

For more information about the generic options, see *Reference information on general debugger options*, page 323.

- 3 On the **Setup** page, make sure to select the appropriate C-SPY driver from the **Driver** drop-down list.
- 4 To set the driver-specific options, select the appropriate driver from the **Category** list. Depending on which C-SPY driver you are using, different options are available.
- 5 To restore all settings to the default factory settings, click the **Factory Settings** button.
- 6 When you have set all the required options, click **OK** in the **Options** dialog box.

---

## Reference information on general debugger options

Reference information about:

- Setup
- Images
- Extra Options
- Plugins

## Setup

The general **Setup** options select the C-SPY driver, the setup macro file, and device description file to use, and specify which default source code location to run to.

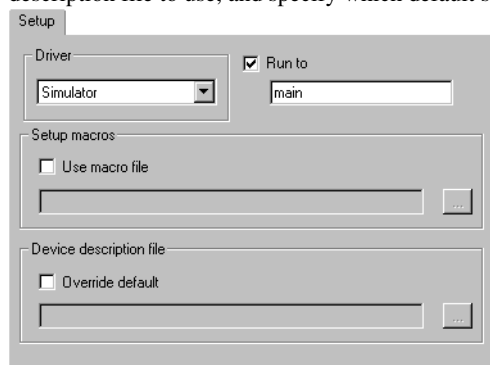

### Driver

Selects the C-SPY driver for the target system you have.

### Run to

Specifies the location C-SPY runs to when the debugger starts after a reset. By default, C-SPY runs to the `main` function.

To override the default location, specify the name of a different location you want C-SPY to run to. You can specify assembler labels or whatever can be evaluated as such, for example function names.

If the option is deselected, the program counter will contain the regular hardware reset address at each reset.

See also *Executing from reset*, page 38.

### Setup macros

Registers the contents of a setup macro file in the C-SPY startup sequence. Select **Use macro file** and specify the path and name of the setup file, for example `SetupSimple.mac`. If no extension is specified, the extension `mac` is assumed. A browse button is available for your convenience.

### Device description file

A default device description file is selected automatically based on your project settings. To override the default file, select **Override default** and specify an alternative file. A browse button is available for your convenience.

For information about the device description file, see *Modifying a device description file*, page 43.

Device description files for each STM8 device are provided in the directory `stm8\config` and have the filename extension `ddf`.

## Images

The **Images** options control the use of additional debug files to be downloaded.

### Download extra Images

Controls the use of additional debug files to be downloaded:

#### Path

Specify the debug file to be downloaded. A browse button is available for your convenience.

#### Offset

Specify an integer that determines the destination address for the downloaded debug file.

#### Debug info only

Makes the debugger download only debug information, and not the complete debug file.

If you want to download more than three images, use the related C-SPY macro, see `__loadImage`, page 277.

For more information, see *Loading multiple images*, page 41.

## Extra Options

The **Extra Options** page provides you with a command line interface to C-SPY.

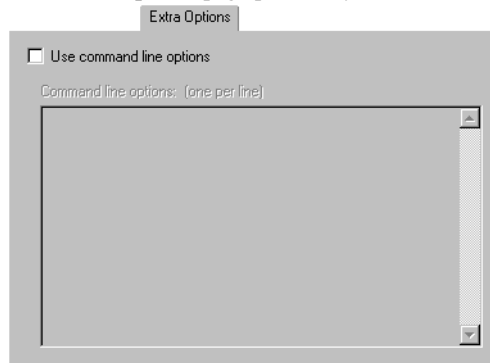

### Use command line options

Specify command line arguments that are not supported by the IDE to be passed to C-SPY.

Note that it is possible to use the `/args` option to pass command line arguments to the debugged application.

Syntax: `/args arg0 arg1 ...`

Multiple lines with `/args` are allowed, for example:

```
/args --logfile log.txt
```

```
/args --verbose
```

If you use `/args`, these variables must be defined in your application:

```
/* __argc, the number of arguments in __argv. */
__no_init int __argc;
```

```
/* __argv, an array of pointers to strings that holds the
arguments; must be large enough to fit the number of
parameters.*/
__no_init const char * __argv[MAX_ARGS];
```

```
/* __argvbuf, a storage area for __argv; must be large enough to
hold all command line parameters. */
__no_init __root char __argvbuf[MAX_ARG_SIZE];
```

## Plugins

The **Plugins** options select the C-SPY plugin modules to be loaded and made available during debug sessions.

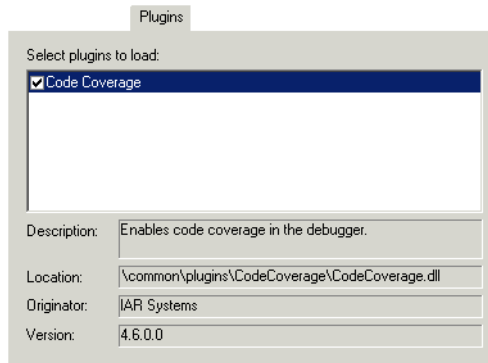

### Select plugins to load

Selects the plugin modules to be loaded and made available during debug sessions. The list contains the plugin modules delivered with the product installation.

### Description

Describes the plugin module.

### Location

Informs about the location of the plugin module.

Generic plugin modules are stored in the `common\plugins` directory. Target-specific plugin modules are stored in the `stm8\plugins` directory.

### Originator

Informs about the originator of the plugin module, which can be modules provided by IAR Systems or by third-party vendors.

### Version

Informs about the version number.

---

## Reference information on C-SPY hardware debugger driver options

Reference information about:

- *Setup options for STice and ST-LINK*, page 328

## Setup options for STIce and ST-LINK

The **Setup** options control the C-SPY STIce driver or the C-SPY ST-LINK driver, respectively.

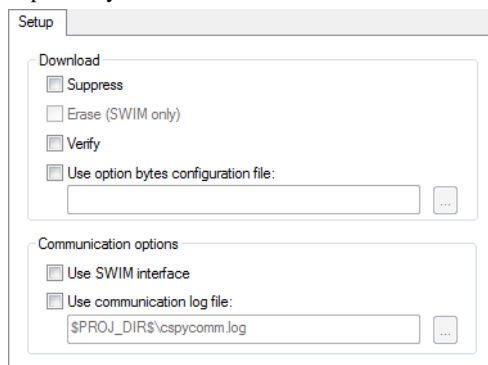

### Download

By default, C-SPY downloads the application to RAM or flash when a debug session starts. The **Download** options let you modify the behavior of the download.

### Suppress

Disables the downloading of code, while preserving the present content of the flash. This command is useful if you want to debug an application that already resides in target memory.

If this option is combined with the **Verify** option, the debugger will read back the code image from non-volatile memory and verify that it is identical to the debugged application.

### Erase

Erases the memory (FLASH, EEPROM, and option bytes) before downloading the code. This is done by first setting the Read-Out Protection option byte and then clearing it (or the other way around if `ROP` is already set). During the clearing phase, all memory areas are erased.

The option is only available for supported devices and when using STIce in SWIM mode or ST-LINK.

### Verify

Verifies that the downloaded code image can be read back from target memory with the correct contents.



**Use option bytes configuration file**

Writes the option bytes settings defined in an option bytes configuration file (obc) to the device before download. The file is created using the Option bytes window, see *Option Bytes dialog box*, page 52.

**Communication options****Use SWIM interface**

Enables the SWIM interface. Using the SWIM interface makes the STice emulator behave as ST-LINK.

This option is only available for the C-SPY STice driver.

**Communication log****Use communication log file**

Logs the communication between C-SPY and the target system to a file. To interpret the result, detailed knowledge of the interface is required.



# Additional information on C-SPY drivers

This chapter describes the additional menus and features provided by the C-SPY® drivers. You will also find some useful hints about resolving problems.

---

## Reference information on C-SPY driver menus

Reference information about:

- *C-SPY driver*, page 331
- *Simulator menu*, page 332
- *The ST-LINK menu*, page 335
- *The STice menu*, page 336

### **C-SPY driver**

Before you start the C-SPY debugger, you must first specify a C-SPY driver in the **Options** dialog box, using the option **Debugger>Setup>Driver**.

When you start a debug session, a menu specific to that C-SPY driver will appear on the menu bar, with commands specific to the driver.

When we in this guide write “choose *C-SPY driver*>” followed by a menu command, *C-SPY driver* refers to the menu. If the feature is supported by the driver, the command will be on the menu.

## Simulator menu

When you use the simulator driver, the **Simulator** menu is added to the menu bar.

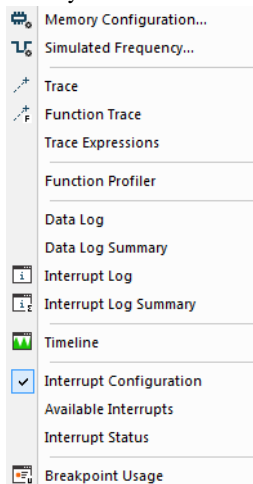

### Menu commands

These commands are available on the menu:



#### Memory Configuration

Displays a dialog box where you configure C-SPY to match the memory of your device, see *Memory Configuration dialog box, for the C-SPY simulator*, page 158.



#### Trace

Opens a window which displays the collected trace data, see *Trace window*, page 170.



#### Function Trace

Opens a window which displays the trace data for function calls and function returns, see *Function Trace window*, page 175.

#### Trace Expressions

Opens a window where you can specify specific variables and expressions for which you want to collect trace data, see *Trace Expressions window*, page 178.

#### Function Profiler

Opens a window which shows timing information for the functions, see *Function Profiler window*, page 216.

**Data Log**

Opens a window which logs accesses to up to four different memory locations or areas, see *Data Log window*, page 196.

**Data Log Summary**

Opens a window which displays a summary of data accesses to specific memory location or areas, see *Data Log Summary window*, page 199.

**Interrupt Log**

Opens a window which displays the status of all defined interrupts, see *Interrupt Log window*, page 243.

**Interrupt Log Summary**

Opens a window which displays a summary of the status of all defined interrupts, see *Interrupt Log Summary window*, page 246.

**Timeline**

Opens a window which gives a graphical view of various kinds of information on a timeline, see *The application timeline*, page 183.

**Simulated Frequency**

Opens the **Simulated Frequency** dialog box where you can specify the simulator frequency used when the simulator displays time information, for example in the log windows. Note that this does not affect the speed of the simulator. For more information, see *Simulated Frequency dialog box*.

**Interrupt Status**

Opens a window from where you can instantly trigger an interrupt, see *Interrupt Status window*, page 241.

**Breakpoint Usage**

Displays a window which lists all active breakpoints, see *Breakpoint Usage window*, page 113.

---

## Reference information on the C-SPY simulator

This section gives additional reference information the C-SPY simulator, reference information not provided elsewhere in this documentation.

Reference information about:

- *Simulated Frequency dialog box*, page 334

## Simulated Frequency dialog box

The **Simulated Frequency** dialog box is available from the C-SPY driver menu.

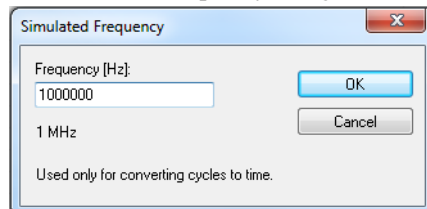

Use this dialog box to specify the simulator frequency used when the simulator displays time information.

### Requirements

The C-SPY simulator.

### Frequency

Specify the frequency in Hz.

---

## Reference information on the C-SPY hardware debugger drivers

This section gives additional reference information on the C-SPY hardware debugger drivers, reference information not provided elsewhere in this documentation.

Reference information about:

- *The ST-LINK menu*, page 335
- *The STice menu*, page 336

## The ST-LINK menu

When you are using the C-SPY driver for ST-LINK, the **ST-LINK** menu is added to the menu bar.

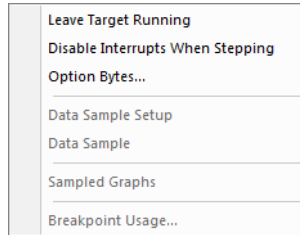

### Menu commands

These menu commands are available on the menu:

#### Leave Target Running

Leaves the application running on the target hardware after the debug session is closed.



Any existing breakpoints will not be automatically removed. You might want to consider disabling all breakpoints before using this menu command.

This menu command is available if your C-SPY driver supports it and if you have selected **Project>Attach to Running Target**.

#### Disable Interrupts When Stepping

Temporarily disables interrupts during hardware single steps. Enabling this function might be useful in cases where it is impossible to move away from an instruction with a breakpoint on it, due to pending interrupts.

#### Option bytes

Opens a window that displays the current state of the option bytes set at the target STM8 device, see *Option Bytes dialog box*, page 52.

#### Data Sample Setup

Opens a window where you can specify variables to sample data for, see *Data Sample Setup window*, page 205.

#### Data Sample

Opens a window where you can view the result of the data sampling, see *Data Sample window*, page 207.

### Sampled Graphs

Opens a window which gives a graphical view of various kinds of sampled information, see *Sampled Graphs window*, page 202.

### Breakpoint Usage

Displays a window which lists all active breakpoints, see *Breakpoint Usage window*, page 113.

## The STice menu

When you are using the C-SPY driver for STice, the **STice** menu is added to the menu bar.

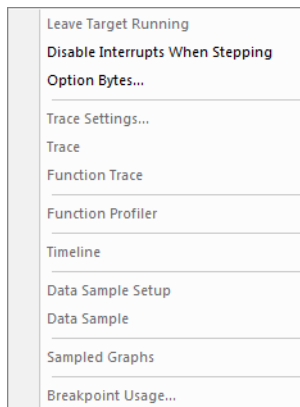

### Menu commands

These menu commands are available on the menu:

#### Leave Target Running

Leaves the application running on the target hardware after the debug session is closed.



Any existing breakpoints will not be automatically removed. You might want to consider disabling all breakpoints before using this menu command.

This menu command is available if your C-SPY driver supports it and if you have selected **Project>Attach to Running Target**.



**Disable Interrupts When Stepping**

Temporarily disables interrupts during hardware single steps. Enabling this function might be useful in cases where it is impossible to move away from an instruction with a breakpoint on it, due to pending interrupts.

**Option bytes**

Opens a window that displays the current state of the option bytes set at the target STM8 device, see *Option Bytes dialog box*, page 52.

**Trace Settings**

Displays the **Trace Settings** dialog box, see *Trace Settings dialog box*, page 168.

**Trace**

Opens the Trace window, see *Trace window*, page 170.

**Function Trace**

Opens the Function Trace window, see *Function Trace window*, page 175.

**Function Profiler**

Opens the Function Profiler window, see *Function Profiler window*, page 216.

**Timeline**

Opens a window which gives a graphical view of various kinds of information on a timeline, see *Reference information on application timeline*, page 188.

**Data Sample Setup**

Opens a window where you can specify variables to sample data for, see *Data Sample Setup window*, page 205.

**Data Sample**

Opens a window where you can view the result of the data sampling, see *Data Sample window*, page 207.

**Sampled Graphs**

Opens a window which gives a graphical view of various kinds of sampled information, see *Sampled Graphs window*, page 202.

**Breakpoint Usage**

Displays a window which lists all active breakpoints, see *Breakpoint Usage window*, page 113.

---

## Resolving problems

These topics are covered:

- Write failure during load
- No contact with the target hardware

Debugging using the C-SPY hardware debugger systems requires interaction between many systems, independent from each other. For this reason, setting up this debug system can be a complex task. If something goes wrong, it might be difficult to locate the cause of the problem.

This section includes suggestions for resolving the most common problems that can occur when debugging with the C-SPY hardware debugger systems.

For problems concerning the operation of the evaluation board, refer to the documentation supplied with it, or contact your hardware distributor.

### WRITE FAILURE DURING LOAD

There are several possible reasons for write failure during load. The most common is that your application has been incorrectly linked:

- Check the contents of your linker configuration file and make sure that your application has not been linked to the wrong address
- Check that you are using the correct linker configuration file.



In the IDE, the linker configuration file is automatically selected based on your choice of device.

#### To choose a device:

- 1 Choose **Project>Options**.
- 2 Select the **General Options** category.
- 3 Click the **Target** tab.
- 4 Choose the appropriate device from the **Device** drop-down list.

#### To override the default linker configuration file:

- 1 Choose **Project>Options**.
- 2 Select the **Linker** category.
- 3 Click the **Config** tab.
- 4 Choose the appropriate linker configuration file in the **Linker configuration file** area.

## **NO CONTACT WITH THE TARGET HARDWARE**

There are several possible reasons for C-SPY to fail to establish contact with the target hardware. Do this:

- Check the communication devices on your host computer
- Verify that the cable is properly plugged in and not damaged or of the wrong type
- Make sure that the evaluation board is supplied with sufficient power
- Check that the correct options for communication have been specified in the IAR Embedded Workbench IDE.

Examine the linker configuration file to make sure that the application has not been linked to the wrong address.



## A

Abort (Report Assert option) . . . . . 73  
 \_\_abortLaunch (C-SPY system macro) . . . . . 269  
 absolute location, specifying for a breakpoint . . . . . 125  
 Access type (Edit Memory Access option) . . . . . 161  
 Access (Edit SFR option) . . . . . 157  
 Add to Watch Window (Symbolic Memory window context menu) . . . . . 144  
 Add (SFR Setup window context menu) . . . . . 155  
 Address Range (Find in Trace option) . . . . . 181  
 Address (Edit SFR option) . . . . . 157  
 advanced breakpoints . . . . . 114  
     break on data access within or outside an address range . . . . . 115  
     break on data value at a given address . . . . . 115  
     break on opcode fetch or data access at given addresses . . . . . 116  
     break on opcode fetch within or outside an address range . . . . . 115  
     break on stack write or data access at a given address . 116  
     break on stack write or opcode fetch at a given address 116  
     break on two sequential opcode fetches . . . . . 115  
     data access at one of two addresses . . . . . 116  
 Ambiguous symbol (Resolve Symbol Ambiguity option) . 99  
 application, built outside the IDE . . . . . 40  
 assembler labels, viewing . . . . . 82  
 assembler source code, fine-tuning . . . . . 211  
 assembler symbols, using in C-SPY expressions . . . . . 79  
 assembler variables, viewing . . . . . 82  
 assumptions, programming experience . . . . . 19  
 Auto Scroll (Sampled Graphs window context menu) . . 203  
 Auto Scroll (Timeline window context menu) . 191, 194, 250  
 Auto window . . . . . 83  
 Autostep settings dialog box . . . . . 74  
 Autostep (Debug menu) . . . . . 47

## B

--attach\_to\_running\_target (C-SPY command line option) 310  
 --backend (C-SPY command line option) . . . . . 311  
 backtrace information  
     viewing in Call Stack window . . . . . 67  
 batch mode, using C-SPY in . . . . . 307  
 Big Endian (Memory window context menu) . . . . . 138  
 blocks, in C-SPY macros . . . . . 263  
 bold style, in this guide . . . . . 23  
 Break on Throw (Debug menu) . . . . . 47  
 Break on Uncaught Exception (Debug menu) . . . . . 47  
 Break (Debug menu) . . . . . 46  
 breakpoint condition, example . . . . . 110  
 Breakpoint Usage window . . . . . 113  
 Breakpoint usage (STIce menu) . . . . . 337  
 Breakpoint usage (ST-LINK menu) . . . . . 336  
 breakpoints  
     code, example . . . . . 287  
     connecting a C-SPY macro . . . . . 258  
     consumers of . . . . . 105  
     data . . . . . 120  
     data log . . . . . 122  
     description of . . . . . 101  
     disabling used by Stack window . . . . . 106  
     icons for in the IDE . . . . . 104  
     in Memory window . . . . . 108  
     listing all . . . . . 113  
     reasons for using . . . . . 101  
     setting  
         in memory window . . . . . 108  
         using system macros . . . . . 109  
         using the dialog box . . . . . 107  
     single-stepping if not available . . . . . 38  
     toggling . . . . . 107  
     types of . . . . . 102  
     useful tips . . . . . 110  
 Breakpoints dialog box  
     Code . . . . . 117

Data	120
Data Log	122
Immediate	123
Log	119
Trace Start	176
Trace Stop	177
Breakpoints window	112
Browse (Trace toolbar)	170
byte order, setting in Memory window	137

## C

C function information, in C-SPY	60
C symbols, using in C-SPY expressions	79
C variables, using in C-SPY expressions	78
call chain, displaying in C-SPY	60
Call stack information	60
Call Stack window	67
for backtrace information	60
Call Stack (Timeline window context menu)	191
__cancelAllInterrupts (C-SPY system macro)	270
__cancelInterrupt (C-SPY system macro)	270
Clear All (Debug Log window context menu)	72
Clear Group (Registers User Groups Setup window context menu)	152
Clear Group (Registers User Groups Setup window context menu)	153
Clear trace data (Trace toolbar)	170
__clearBreak (C-SPY system macro)	271
clock frequency, simulated	334
__closeFile (C-SPY system macro)	271
code breakpoints	
overview	102
toggling	107
Code Coverage window	222
Code Coverage (Disassembly window context menu)	65
--code_coverage_file (C-SPY command line option)	311
code, covering execution of	222

command line options	310
typographic convention	22
command prompt icon, in this guide	23
Communication log (ST-LINK option)	329
computer style, typographic convention	22
conditional statements, in C-SPY macros	262
context menu, in windows	81
conventions, used in this guide	22
Copy Window Contents (Disassembly window context menu)	67
Copy (Debug Log window context menu)	72
copyright notice	2
Core (Cores window)	75
cores	
inspecting state of	74
Cores window	74
csybat	307
reading options from file (-f)	314
current position, in C-SPY Disassembly window	64
cursor, in C-SPY Disassembly window	64
--cycles (C-SPY command line option)	312
Cycles (Cores window)	75
C-SPY	
batch mode, using in	307
debugger systems, overview of	30
environment overview	27
plugin modules, loading	39
setting up	37–38
starting the debugger	39
C-SPY drivers	
differences between drivers	33
overview	32
specifying	324
types of	31
C-SPY expressions	78
evaluating, using Macro Quicklaunch window	305
evaluating, using Quick Watch window	95
in C-SPY macros	262
Tooltip watch, using	77
Watch window, using	77

- C-SPY macros
    - blocks . . . . . 263
    - conditional statements . . . . . 262
    - C-SPY expressions . . . . . 262
    - examples . . . . . 255
      - checking status of register . . . . . 257
      - creating a log macro . . . . . 258
    - executing . . . . . 255
      - connecting to a breakpoint . . . . . 258
      - using Quick Watch . . . . . 257
      - using setup macro and setup file . . . . . 257
    - functions . . . . . 80, 260
    - keywords . . . . . 260–261, 263
    - loop statements . . . . . 263
    - macro statements . . . . . 262
    - parameters . . . . . 261
    - setup macro file . . . . . 254
      - executing . . . . . 257
    - setup macro functions . . . . . 254
      - summary . . . . . 265
    - system macros, summary of . . . . . 267
    - using . . . . . 253
    - variables . . . . . 80, 260
  - C-SPY options
    - Extra Options . . . . . 326
    - Images . . . . . 325
    - Plugins . . . . . 327
    - Setup . . . . . 324
  - C-SPYLink . . . . . 32
  - C-STAT for static analysis, documentation for . . . . . 21
  - C++ terminology . . . . . 22
- D**
- data breakpoints, overview . . . . . 103
  - Data Coverage (Memory window context menu) . . . . . 138
  - data coverage, in Memory window . . . . . 136
  - data log breakpoints, overview . . . . . 103
  - Data Log Summary window . . . . . 199
  - Data Log Summary (Simulator menu) . . . . . 333
  - Data Log window . . . . . 196
  - Data Log (Simulator menu) . . . . . 333
  - Data Log (Timeline window context menu) . . . . . 195
  - Data Sample Setup window . . . . . 205
  - Data Sample Setup (STice menu) . . . . . 337
  - Data Sample Setup (ST-LINK menu) . . . . . 335
  - Data Sample window . . . . . 207
  - Data Sample (Sampled Graphs window context menu) . . . . . 204
  - Data Sample (STice menu) . . . . . 337
  - Data Sample (ST-LINK menu) . . . . . 335
  - ddf (filename extension), selecting a file . . . . . 39
  - Debug Log window . . . . . 71
  - Debug menu (C-SPY main window) . . . . . 46
  - Debug (Report Assert option) . . . . . 73
  - debugfile (cspybat option) . . . . . 312
  - debugger concepts, definitions of . . . . . 29
  - debugger drivers
    - simulator . . . . . 33
  - debugger drivers. *See* C-SPY drivers
  - Debugger Macros window . . . . . 303
  - debugger system overview . . . . . 30
  - debugging projects
    - externally built applications . . . . . 40
    - loading multiple images . . . . . 41
  - debugging, RTOS awareness . . . . . 29
  - \_\_delay (C-SPY system macro) . . . . . 271
  - Delay (Autostep Settings option) . . . . . 74
  - Delete (Breakpoints window context menu) . . . . . 113
  - Delete (SFR Setup window context menu) . . . . . 155
  - Delete/revert All Custom SFRs (SFR Setup window context menu) . . . . . 155
  - Description (Edit Interrupt option) . . . . . 238
  - description (interrupt property) . . . . . 238
  - Device description file (debugger option) . . . . . 324
  - device description files . . . . . 39
    - definition of . . . . . 43
    - modifying . . . . . 43
    - specifying interrupts . . . . . 282
  - Disable All (Breakpoints window context menu) . . . . . 113

Disable Interrupts When Stepping (STice menu) . . . . .	337
Disable Interrupts When Stepping (ST-LINK menu) . . . . .	335
Disable (Breakpoints window context menu) . . . . .	113
__disableInterrupts (C-SPY system macro) . . . . .	272
--disable_interrupts (C-SPY command line option) . . . . .	313
Disassembly window . . . . .	63
context menu . . . . .	65
disclaimer . . . . .	2
DLIB	
naming convention . . . . .	23
do (macro statement) . . . . .	263
document conventions . . . . .	22
documentation	
overview of guides . . . . .	21
overview of this guide . . . . .	19
Download (ST-LINK option) . . . . .	328
--download_only (C-SPY command line option) . . . . .	313
Driver (debugger option) . . . . .	324
__driverType (C-SPY system macro) . . . . .	272

## E

Edit Expressions (Trace toolbar) . . . . .	171
Edit Memory Range dialog box . . . . .	156
Edit Memory Range dialog box (C-SPY simulator) . . . . .	160
Edit Settings (Trace toolbar) . . . . .	170–171
Edit (Breakpoints window context menu) . . . . .	112
Edit (SFR Setup window context menu) . . . . .	155
edition, of this guide . . . . .	2
Enable All (Breakpoints window context menu) . . . . .	113
Enable interrupt simulation (Interrupt Setup option) . . . . .	239
Enable Log File (Log File option) . . . . .	72
Enable (Breakpoints window context menu) . . . . .	113
Enable (Sampled Graphs window context menu) . . . . .	204
Enable (Timeline window context menu) . . . . .	191, 250
__enableInterrupts (C-SPY system macro) . . . . .	273
Enable/Disable Breakpoint (Call Stack window context menu) . . . . .	69

Enable/Disable Breakpoint (Disassembly window context menu) . . . . .	66
Enable/Disable (Trace toolbar) . . . . .	170
End address (Memory Save option) . . . . .	139
endianness. <i>See</i> byte order	
Enter Location dialog box . . . . .	124
--erase_memory (C-SPY command line option) . . . . .	313
__evaluate (C-SPY system macro) . . . . .	273
Evaluate Now (Macro Quicklaunch window context menu) . . . . .	306
examples	
C-SPY macros . . . . .	255
interrupts	
interrupt logging . . . . .	236
timer . . . . .	234
macros	
checking status of register . . . . .	257
creating a log macro . . . . .	258
using Quick Watch . . . . .	257
performing tasks and continue execution . . . . .	110
tracing incorrect function arguments . . . . .	110
execUserExecutionStarted (C-SPY setup macro) . . . . .	266
execUserExecutionStopped (C-SPY setup macro) . . . . .	266
execUserExit (C-SPY setup macro) . . . . .	267
execUserPreload (C-SPY setup macro) . . . . .	265
execUserPreReset (C-SPY setup macro) . . . . .	267
execUserReset (C-SPY setup macro) . . . . .	267
execUserSetup (C-SPY setup macro) . . . . .	266
executed code, covering . . . . .	222
execution history, tracing . . . . .	167
Execution state (Cores window) . . . . .	74
expressions. <i>See</i> C-SPY expressions	
extended command line file, for cspybat . . . . .	314
Extra Options, for C-SPY . . . . .	326

## F

-f (cspybat option) . . . . .	314
File format (Memory Save option) . . . . .	139



file types  
  device description, specifying in IDE . . . . . 39  
  macro . . . . . 38, 324

filename extensions  
  ddf, selecting device description file . . . . . 39  
  mac, using macro file . . . . . 38

Filename (Memory Restore option) . . . . . 140

Filename (Memory Save option) . . . . . 140

Fill dialog box . . . . . 141

\_\_writeMemory8 (C-SPY system macro) . . . . . 274

\_\_writeMemory16 (C-SPY system macro) . . . . . 274

\_\_writeMemory32 (C-SPY system macro) . . . . . 275

Find in Trace dialog box . . . . . 180

Find in Trace window . . . . . 181

Find in Trace (Disassembly window context menu) . . . . . 67

Find (Memory window context menu) . . . . . 138

Find (Trace toolbar) . . . . . 170

first activation time (interrupt property)  
  definition of . . . . . 230

First activation (Edit Interrupt option) . . . . . 238

flash memory, load library module to . . . . . 277

\_\_fmessage (C-SPY macro keyword) . . . . . 263

for (macro statement) . . . . . 263

Force Interrupt  
  (Available Interrupts window context menu) . . . . . 241

Forced Interrupt window . . . . . 240

Forced Interrupts (Simulator menu) . . . . . 333

Format (Registers User Groups  
  Setup window context menu) . . . . . 152

Format (Registers window context menu) . . . . . 151

Function Profiler window . . . . . 216

Function Profiler (Simulator menu) . . . . . 332

Function profiler (STice menu) . . . . . 337

Function Trace window . . . . . 175

Function trace (STice menu) . . . . . 337

functions  
  C-SPY running to when starting . . . . . 38, 324  
  most time spent in, locating . . . . . 211

## G

Go to Source (Breakpoints window context menu) . . . . . 112

Go to Source (Call Stack window context menu) . . . . . 68

Go To Source (Timeline window context menu) . . . . . 191–192,  
  196, 250

Go (Debug menu) . . . . . 46, 59

## H

highlighting, in C-SPY . . . . . 60

Hold time (Edit Interrupt option) . . . . . 238

hold time (interrupt property), definition of . . . . . 231

## I

icons, in this guide . . . . . 23

if else (macro statement) . . . . . 262

if (macro statement) . . . . . 262

Ignore (Report Assert option) . . . . . 73

Images window . . . . . 49

Images, loading multiple . . . . . 325

immediate breakpoints, overview . . . . . 103

Include (Log File option) . . . . . 72

Input Mode dialog box . . . . . 70

input, special characters in Terminal I/O window . . . . . 70

installation directory . . . . . 22

Instruction Profiling (Disassembly window context menu) . . . . . 66

Intel-extended, C-SPY output format . . . . . 32

Interrupt Log Summary window . . . . . 246

Interrupt Log window . . . . . 243

Interrupt Setup dialog box . . . . . 237

Interrupt Status window . . . . . 241

interrupt system, using device description file . . . . . 233

Interrupt (Edit Interrupt option) . . . . . 239

Interrupt (Timeline window context menu) . . . . . 250

interrupts  
  adapting C-SPY system for target hardware . . . . . 233  
  simulated, introduction to . . . . . 229

timer, example . . . . .	234
using system macros . . . . .	232
<code>__isBatchMode</code> (C-SPY system macro) . . . . .	276
italic style, in this guide . . . . .	22–23

## L

labels (assembler), viewing . . . . .	82
Leave Target Running (C-SPY driver menu command) . . . . .	335–336
<code>--leave_target_running</code> (C-SPY command line option) . . . . .	314
Length (Fill option) . . . . .	141
library functions	
C-SPY support for using, plugin module . . . . .	318
online help for . . . . .	21
lightbulb icon, in this guide . . . . .	23
linker options	
typographic convention . . . . .	22
Little Endian (Memory window context menu) . . . . .	137
Live Watch window . . . . .	90
<code>__loadImage</code> (C-SPY system macro) . . . . .	277
loading multiple debug files, list currently loaded . . . . .	49
loading multiple images . . . . .	41
Locals window . . . . .	85
log breakpoints, overview . . . . .	102
Log File dialog box . . . . .	72
Logging>Set Log file (Debug menu) . . . . .	48
Logging>Set Terminal I/O Log file (Debug menu) . . . . .	48
<code>--log_file</code> (C-SPY command line option) . . . . .	315
loop statements, in C-SPY macros . . . . .	263

## M

mac (filename extension), using a macro file . . . . .	38
<code>--macro</code> (C-SPY command line option) . . . . .	315
macro files, specifying . . . . .	38, 324
Macro Quicklaunch window . . . . .	305
Macro Registration window . . . . .	301
macro statements . . . . .	262

macros	
executing . . . . .	255
using . . . . .	253
<code>--macro-param</code> (C-SPY command line option) . . . . .	316
main function, C-SPY running to when starting . . . . .	38, 324
<code>--mapu</code> (C-SPY command line option) . . . . .	316
<code>--mcuname</code> (C-SPY command line option) . . . . .	317
Memory access checking (Memory Access Setup option) . . . . .	159
Memory Configuration dialog box (in C-SPY simulator) . . . . .	158
Memory Fill (Memory window context menu) . . . . .	138
Memory Restore dialog box . . . . .	140
Memory Restore (Memory window context menu) . . . . .	138
Memory Save dialog box . . . . .	139
Memory Save (Memory window context menu) . . . . .	138
Memory window . . . . .	135
memory zones . . . . .	128
<code>__memoryRestore</code> (C-SPY system macro) . . . . .	278
<code>__memorySave</code> (C-SPY system macro) . . . . .	278
Memory>Restore (Debug menu) . . . . .	47
Memory>Save (Debug menu) . . . . .	47
menu bar, C-SPY-specific . . . . .	45
<code>__message</code> (C-SPY macro keyword) . . . . .	263
<code>__messageBoxYesCancel</code> (C-SPY system macro) . . . . .	279
<code>__messageBoxYesNo</code> (C-SPY system macro) . . . . .	280
Messages window, amount of output . . . . .	71
MISRA C	
documentation . . . . .	21
Mixed Mode (Disassembly window context menu) . . . . .	67
Motorola, C-SPY output format . . . . .	32
Move to PC (Disassembly window context menu) . . . . .	65

## N

Name (Edit SFR option) . . . . .	156
naming conventions . . . . .	23
Navigate (Sampled Graphs window context menu) . . . . .	203
Navigate (Timeline window context menu) . . . . .	190, 194, 249
New Breakpoint (Breakpoints window context menu) . . . . .	113
Next Statement (Debug menu) . . . . .	47

Next Symbol (Symbolic Memory window context menu) 144

## O

Open User Groups Setup Window (Registers window context menu) . . . . . 151  
 \_\_openFile (C-SPY system macro) . . . . . 280  
 Operation (Fill option) . . . . . 141  
 operators, sizeof in C-SPY . . . . . 80  
 optimizations, effects on variables . . . . . 80  
 option bytes  
   setting . . . . . 44  
 Option Bytes dialog box . . . . . 52  
 Option bytes (STice menu) . . . . . 337  
 Option bytes (ST-LINK menu) . . . . . 335  
 options  
   in the IDE . . . . . 323  
   on the command line . . . . . 310, 326  
 Options (Stack window context menu) . . . . . 148  
 \_\_orderInterrupt (C-SPY system macro) . . . . . 282  
 Originator (debugger option) . . . . . 327

## P

-p (C-SPY command line option) . . . . . 317  
 \_\_param (C-SPY macro keyword) . . . . . 261  
 parameters  
   tracing incorrect values of . . . . . 60  
   typographic convention . . . . . 22  
 part number, of this guide . . . . . 2  
 PC (Cores window) . . . . . 75  
 peripheral units  
   device-specific . . . . . 43  
   displayed in Registers window . . . . . 128  
   in C-SPY expressions . . . . . 79  
   initializing using setup macros . . . . . 254  
 Please select one symbol  
 (Resolve Symbol Ambiguity option) . . . . . 100  
 --plugin (C-SPY command line option) . . . . . 317

plugin modules (C-SPY) . . . . . 32  
   loading . . . . . 39  
 Plugins (C-SPY options) . . . . . 327  
 \_\_popSimulatorInterruptExecutingStack (C-SPY system macro) . . . . . 283  
 pop-up menu. *See* context menu  
 prerequisites, programming experience . . . . . 19  
 Previous Symbol (Symbolic Memory window context menu) . . . . . 144  
 probability (interrupt property) . . . . . 238  
   definition of . . . . . 230  
 Probability % (Edit Interrupt option) . . . . . 238  
 Profile Selection (Timeline window context menu) . . . . . 192  
 profiling  
   analyzing data . . . . . 213  
   on function level . . . . . 213  
   on instruction level. . . . . 215  
 profiling information, on functions and instructions . . . . . 211  
 profiling sources  
   trace (calls) . . . . . 212, 218  
   trace (flat) . . . . . 212, 218  
 program execution  
   breaking . . . . . 102–103  
   in C-SPY . . . . . 55  
 programming experience . . . . . 19  
 program. *See* application  
 projects, for debugging externally built applications. . . . . 40  
 publication date, of this guide . . . . . 2

## Q

Quick Watch window . . . . . 95  
   executing C-SPY macros . . . . . 257

## R

Range for (Viewing Range option) . . . . . 209  
 \_\_readFile (C-SPY system macro) . . . . . 283  
 \_\_readFileByte (C-SPY system macro) . . . . . 284

__readMemoryByte (C-SPY system macro) . . . . .	284
__readMemory8 (C-SPY system macro) . . . . .	284
__readMemory16 (C-SPY system macro) . . . . .	285
__readMemory32 (C-SPY system macro) . . . . .	285
reference information, typographic convention. . . . .	23
Refresh (Debug menu) . . . . .	48
register groups . . . . .	128
predefined, enabling. . . . .	149
Register User Groups Setup window . . . . .	151
registered trademarks . . . . .	2
__registerMacroFile (C-SPY system macro) . . . . .	286
Registers window . . . . .	148
registers, displayed in Registers window . . . . .	148
Remove All (Macro Quicklaunch window context menu) . . . . .	306
Remove (Macro Quicklaunch window context menu) . . . . .	306
Remove (Registers User Groups Setup window context menu) . . . . .	152
Repeat interval (Edit Interrupt option) . . . . .	238
repeat interval (interrupt property), definition of . . . . .	230
Replace (Memory window context menu) . . . . .	138
Report Assert dialog box . . . . .	73
Reset (Debug menu) . . . . .	46
__resetFile (C-SPY system macro) . . . . .	286
Resolve Source Ambiguity dialog box . . . . .	126
Restore (Memory Restore option). . . . .	140
return (macro statement). . . . .	263
ROM-monitor, definition of . . . . .	31
RTOS awareness debugging. . . . .	29
RTOS awareness (C-SPY plugin module) . . . . .	29
Run to Cursor (Call Stack window context menu) . . . . .	68
Run to Cursor (Debug menu) . . . . .	47
Run to Cursor (Disassembly window context menu) . . . . .	65
Run to Cursor, command for executing . . . . .	60
Run to (C-SPY option) . . . . .	38, 324

## S

Sampled Graphs window . . . . .	202
---------------------------------	-----

Sampled Graphs (STice menu) . . . . .	337
Sampled Graphs (ST-LINK menu) . . . . .	336
Save Custom SFRs (SFR Setup window context menu) . . . . .	156
Save to File (Register User Groups Setup window context menu) . . . . .	153
Save to File (Registers window context menu). . . . .	151
Save (Memory Save option) . . . . .	140
Save (Trace toolbar) . . . . .	170
Scale (Viewing Range option) . . . . .	210
Select All (Debug Log window context menu). . . . .	72
Select Graphs (Sampled Graphs window context menu). . . . .	205
Select Graphs (Timeline window context menu)192, 196, 251	
Select plugins to load (debugger option). . . . .	327
Set Data Breakpoint (Memory window context menu) . . . . .	138
Set Data Log Breakpoint (Memory window context menu) . . . . .	139
Set Next Statement (Debug menu) . . . . .	47
Set Next Statement (Disassembly window context menu) . . . . .	66
__setCodeBreak (C-SPY system macro). . . . .	287
__setDataBreak (C-SPY system macro) . . . . .	288
__setDataLogBreak (C-SPY system macro) . . . . .	289
__setLogBreak (C-SPY system macro) . . . . .	290
__setSimBreak (C-SPY system macro) . . . . .	291
setting option bytes. . . . .	44
__setTraceStartBreak (C-SPY system macro) . . . . .	292
__setTraceStopBreak (C-SPY system macro). . . . .	293
setup macro file, registering . . . . .	38
setup macro functions . . . . .	254
reserved names. . . . .	265
Setup macros (debugger option) . . . . .	324
Setup (C-SPY options) . . . . .	324
setupsimple.mac . . . . .	253
SFR . . . . .	
using as assembler symbols . . . . .	79
SFR Setup window . . . . .	153
shortcut menu. <i>See</i> context menu . . . . .	
Show all images (Images window context menu) . . . . .	50
Show All (SFR Setup window context menu). . . . .	155
Show Arguments (Call Stack window context menu). . . . .	68

Show Custom SFRs only (SFR Setup window context menu) . . . . . 155

Show Factory SFRs only (SFR Setup window context menu) . . . . . 155

Show Numerical Value (Timeline window context menu) . . . . . 196, 205

Show offsets (Stack window context menu) . . . . . 147

Show only (Image window context menu) . . . . . 50

Show variables (Stack window context menu) . . . . . 147

--silent (C-SPY command line option) . . . . . 318

Simulated Frequency dialog box . . . . . 334

simulating interrupts, enabling/disabling . . . . . 239

Simulator menu . . . . . 332

simulator, introduction . . . . . 33

Size (Edit SFR option) . . . . . 157

Size (Sampled Graphs window context menu) . . . . . 205

Size (Timeline window context menu) . . . . . 195

sizeof . . . . . 80

\_\_smessage (C-SPY macro keyword) . . . . . 263

software breakpoints, use of . . . . . 105

Solid Graph (Sampled Graphs window context menu) . . . . . 205

Solid Graph (Timeline window context menu) . . . . . 195

\_\_sourcePosition (C-SPY system macro) . . . . . 294

special function registers (SFR)

- using as assembler symbols . . . . . 79

Stack window . . . . . 145

stack.mac . . . . . 253

standard C, sizeof operator in C-SPY . . . . . 80

Start address (Fill option) . . . . . 141

Start address (Memory Save option) . . . . . 139

static analysis

- documentation for . . . . . 21

Statics window . . . . . 92

Status (Cores window) . . . . . 75

Step Into (Debug menu) . . . . . 47

Step Into, description . . . . . 57

Step Out (Debug menu) . . . . . 47

Step Out, description . . . . . 58

Step Over (Debug menu) . . . . . 47

Step Over, description . . . . . 57

step points, definition of . . . . . 56

STice (C-SPY driver), hardware installation . . . . . 35

Stop Debugging (Debug menu) . . . . . 47

\_\_strFind (C-SPY system macro) . . . . . 294

ST-LINK (C-SPY driver), hardware installation . . . . . 35

\_\_subString (C-SPY system macro) . . . . . 295

--suppress\_download (C-SPY command line option) . . . . . 318

--swim (C-SPY command line option) . . . . . 319

Symbolic Memory window . . . . . 142

Symbols window . . . . . 98

symbols, using in C-SPY expressions . . . . . 78

## T

target system, definition of . . . . . 31

\_\_targetDebuggerVersion (C-SPY system macro) . . . . . 295

Terminal IO Log Files (Terminal IO Log Files option) . . . . . 70

Terminal I/O Log Files dialog box . . . . . 70

Terminal I/O window . . . . . 61, 69

terminology . . . . . 22

Text search (Find in Trace option) . . . . . 180

Time Axis Unit (Timeline window context menu) . . . . . 192, 196, 251

Timeline window . . . . . 189, 192

Timeline (STice menu) . . . . . 337

--timeout (C-SPY command line option) . . . . . 319

timer interrupt, example . . . . . 234

Toggle Breakpoint (Code) (Call Stack window context menu) . . . . . 68

Toggle Breakpoint (Code) (Disassembly window context menu) . . . . . 66

Toggle Breakpoint (Log) (Call Stack window context menu) . . . . . 68

Toggle Breakpoint (Log) (Disassembly window context menu) . . . . . 66

Toggle Breakpoint (Trace Start) (Call Stack window context menu) . . . . . 69

Toggle Breakpoint (Trace Start) (Disassembly window context menu) . . . . . 66

Toggle Breakpoint (Trace Stop) (Call Stack window context menu) . . . . .	69
Toggle Breakpoint (Trace Stop) (Disassembly window context menu) . . . . .	66
Toggle source (Trace toolbar) . . . . .	170
__toLower (C-SPY system macro) . . . . .	296
tools icon, in this guide . . . . .	23
__toString (C-SPY system macro) . . . . .	296
__toUpper (C-SPY system macro) . . . . .	297
trace . . . . .	165, 183
Trace Expressions window . . . . .	178
Trace settings (STice menu) . . . . .	337
trace start and stop breakpoints, overview . . . . .	102
Trace Start breakpoints dialog box . . . . .	176
Trace Stop breakpoints dialog box . . . . .	177
Trace types (Trace Settings option) . . . . .	169
Trace window . . . . .	170
trace (calls), profiling source . . . . .	212, 218
trace (flat), profiling source . . . . .	212, 218
Trace (STice menu) . . . . .	337
trace, in Timeline window . . . . .	189, 192
trademarks . . . . .	2
typographic conventions . . . . .	22

## U

Unavailable, C-SPY message . . . . .	81
__unloadImage(C-SPY system macro) . . . . .	297
Use command line options (debugger option) . . . . .	326
Use Extra Images (debugger option) . . . . .	325
Use manual ranges (Memory Access Setup option) . . . . .	159
Use ranges based on (Memory Access Setup option) . . . . .	158
user application, definition of . . . . .	31

## V

Value (Fill option) . . . . .	141
__var (C-SPY macro keyword) . . . . .	260

variables . . . . .	80
effects of optimizations . . . . .	80
information, limitation on . . . . .	80
using in C-SPY expressions . . . . .	78
variance (interrupt property), definition of . . . . .	231
Variance % (Edit Interrupt option) . . . . .	238
--verify_download (C-SPY command line option) . . . . .	319
version number . . . . .	2
of this guide . . . . .	2
View Group (Registers window context menu) . . . . .	150
View User Group (Registers window context menu) . . . . .	151
Viewing Range dialog box . . . . .	209
Viewing Range (Sampled Graphs window context menu) . . . . .	204
Viewing Range (Timeline window context menu) . . . . .	195
visualSTATE, C-SPY plugin module for . . . . .	32

## W

warnings icon, in this guide . . . . .	23
Watch window . . . . .	87
using . . . . .	77
web sites, recommended . . . . .	22
while (macro statement) . . . . .	263
windows, specific to C-SPY . . . . .	48
__writeFile (C-SPY system macro) . . . . .	298
__writeFileByte (C-SPY system macro) . . . . .	298
__writeMemoryByte (C-SPY system macro) . . . . .	299
__writeMemory8 (C-SPY system macro) . . . . .	299
__writeMemory16 (C-SPY system macro) . . . . .	299
__writeMemory32 (C-SPY system macro) . . . . .	300

## Z

zone . . . . .	128
in C-SPY . . . . .	128
part of an absolute address . . . . .	125
Zone (Edit SFR option) . . . . .	157
Zoom (Sampled Graphs window context menu) . . . . .	204
Zoom (Timeline window context menu) . . . . .	191, 195, 250

# Symbols

<code>__abortLaunch</code> (C-SPY system macro) . . . . .	269
<code>__cancelAllInterrupts</code> (C-SPY system macro) . . . . .	270
<code>__cancelInterrupt</code> (C-SPY system macro) . . . . .	270
<code>__clearBreak</code> (C-SPY system macro) . . . . .	271
<code>__closeFile</code> (C-SPY system macro) . . . . .	271
<code>__delay</code> (C-SPY system macro) . . . . .	271
<code>__disableInterrupts</code> (C-SPY system macro) . . . . .	272
<code>__driverType</code> (C-SPY system macro) . . . . .	272
<code>__enableInterrupts</code> (C-SPY system macro) . . . . .	273
<code>__evaluate</code> (C-SPY system macro) . . . . .	273
<code>__fillMemory8</code> (C-SPY system macro) . . . . .	274
<code>__fillMemory16</code> (C-SPY system macro) . . . . .	274
<code>__fillMemory32</code> (C-SPY system macro) . . . . .	275
<code>__fmessage</code> (C-SPY macro keyword) . . . . .	263
<code>__isBatchMode</code> (C-SPY system macro) . . . . .	276
<code>__loadImage</code> (C-SPY system macro) . . . . .	277
<code>__memoryRestore</code> (C-SPY system macro) . . . . .	278
<code>__memorySave</code> (C-SPY system macro) . . . . .	278
<code>__message</code> (C-SPY macro keyword) . . . . .	263
<code>__messageBoxYesCancel</code> (C-SPY system macro) . . . . .	279
<code>__messageBoxYesNo</code> (C-SPY system macro) . . . . .	280
<code>__openFile</code> (C-SPY system macro) . . . . .	280
<code>__orderInterrupt</code> (C-SPY system macro) . . . . .	282
<code>__param</code> (C-SPY macro keyword) . . . . .	261
<code>__popSimulatorInterruptExecutingStack</code> (C-SPY system macro) . . . . .	283
<code>__readFile</code> (C-SPY system macro) . . . . .	283
<code>__readFileByte</code> (C-SPY system macro) . . . . .	284
<code>__readMemoryByte</code> (C-SPY system macro) . . . . .	284
<code>__readMemory8</code> (C-SPY system macro) . . . . .	284
<code>__readMemory16</code> (C-SPY system macro) . . . . .	285
<code>__readMemory32</code> (C-SPY system macro) . . . . .	285
<code>__registerMacroFile</code> (C-SPY system macro) . . . . .	286
<code>__resetFile</code> (C-SPY system macro) . . . . .	286
<code>__setCodeBreak</code> (C-SPY system macro) . . . . .	287
<code>__setDataBreak</code> (C-SPY system macro) . . . . .	288
<code>__setDataLogBreak</code> (C-SPY system macro) . . . . .	289
<code>__setLogBreak</code> (C-SPY system macro) . . . . .	290
<code>__setSimBreak</code> (C-SPY system macro) . . . . .	291
<code>__setTraceStartBreak</code> (C-SPY system macro) . . . . .	292
<code>__setTraceStopBreak</code> (C-SPY system macro) . . . . .	293
<code>__smessage</code> (C-SPY macro keyword) . . . . .	263
<code>__sourcePosition</code> (C-SPY system macro) . . . . .	294
<code>__strFind</code> (C-SPY system macro) . . . . .	294
<code>__subString</code> (C-SPY system macro) . . . . .	295
<code>__targetDebuggerVersion</code> (C-SPY system macro) . . . . .	295
<code>__toLowerCase</code> (C-SPY system macro) . . . . .	296
<code>__toString</code> (C-SPY system macro) . . . . .	296
<code>__toUpperCase</code> (C-SPY system macro) . . . . .	297
<code>__unloadImage</code> (C-SPY system macro) . . . . .	297
<code>__var</code> (C-SPY macro keyword) . . . . .	260
<code>__writeFile</code> (C-SPY system macro) . . . . .	298
<code>__writeFileByte</code> (C-SPY system macro) . . . . .	298
<code>__writeMemoryByte</code> (C-SPY system macro) . . . . .	299
<code>__writeMemory8</code> (C-SPY system macro) . . . . .	299
<code>__writeMemory16</code> (C-SPY system macro) . . . . .	299
<code>__writeMemory32</code> (C-SPY system macro) . . . . .	300
<code>-f</code> (cspybat option) . . . . .	314
<code>-p</code> (C-SPY command line option) . . . . .	317
<code>--attach_to_running_target</code> (C-SPY command line option) . . . . .	310
<code>--backend</code> (C-SPY command line option) . . . . .	311
<code>--code_coverage_file</code> (C-SPY command line option) . . . . .	311
<code>--cycles</code> (C-SPY command line option) . . . . .	312
<code>--debugfile</code> (cspybat option) . . . . .	312
<code>--disable_interrupts</code> (C-SPY command line option) . . . . .	313
<code>--download_only</code> (C-SPY command line option) . . . . .	313
<code>--erase_memory</code> (C-SPY command line option) . . . . .	313
<code>--leave_target_running</code> (C-SPY command line option) . . . . .	314
<code>--log_file</code> (C-SPY command line option) . . . . .	315
<code>--macro</code> (C-SPY command line option) . . . . .	315
<code>--macro_param</code> (C-SPY command line option) . . . . .	316
<code>--mapu</code> (C-SPY command line option) . . . . .	316
<code>--mcuname</code> (C-SPY command line option) . . . . .	317
<code>--plugin</code> (C-SPY command line option) . . . . .	317
<code>--silent</code> (C-SPY command line option) . . . . .	318
<code>--suppress_download</code> (C-SPY command line option) . . . . .	318

--swim (C-SPY command line option) . . . . .	319
--timeout (C-SPY command line option) . . . . .	319
--verify_download (C-SPY command line option) . . . . .	319

## Numerics

1x Units (Memory window context menu) . . . . .	147
1x Units (Symbolic Memory window context menu) . . . . .	144
2x Units (Memory window context menu) . . . . .	147
4x Units (Memory window context menu) . . . . .	147
8x Units (Memory window context menu) . . . . .	137